

TOSHIBA BiCMOS INTEGRATED CIRCUIT, SILICON MONOLITHIC

TB1261F/TB1262F

PAL/NTSC/SECAM 1CHIP
(IF + VCD PROCESSOR)

The TB1261F/TB1262F are TV signal processor ICs, which contains PIF, SIF, Video, Chroma and Deflection blocks. They can be applied for worldwide Multi system TV sets.

The flexibility of this TB1261F/TB1262F contributes to reduce development costs and components in a TV set.

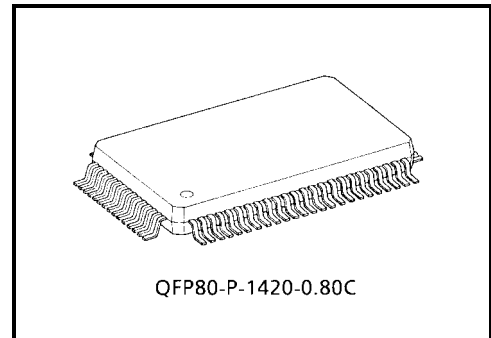

FEATURES

- IF
 - Integrated PIF VCO, aligned automatically.
 - Inter/ split carrier input
 - SIF BPF built-in
 - SIF Trap filter built in
 - Tank-less SIF demodulator
 - Neg/pos demodulation PIF line up *
 - AM sound demodulation line up *
 - Video
 - Chroma trap
 - Y delay line
 - Black stretch
 - Y-gamma
 - Pre/over shoot control
 - VM signal output
 - Chroma
 - PAL/ NTSC/ SECAM demodulation with 1Xtal and Built in 1HDL system
 - External YCbCr in/out Interface
 - Base band TINT
 - SCART RGB interface
 - RGB Analog RGB interface
 - Half-tone and transparent for OSD
 - RGB cut-off/ drive controls by bus
 - ABCL (ABL and ACL combined)
 - Sync./ DEF HVCO integrated
 - V saw tooth single output
 - EW output available for flat wide TV
- *: TB1262F only

1, Block diagram

TB1261F/62F BLOCK DIAGRAM

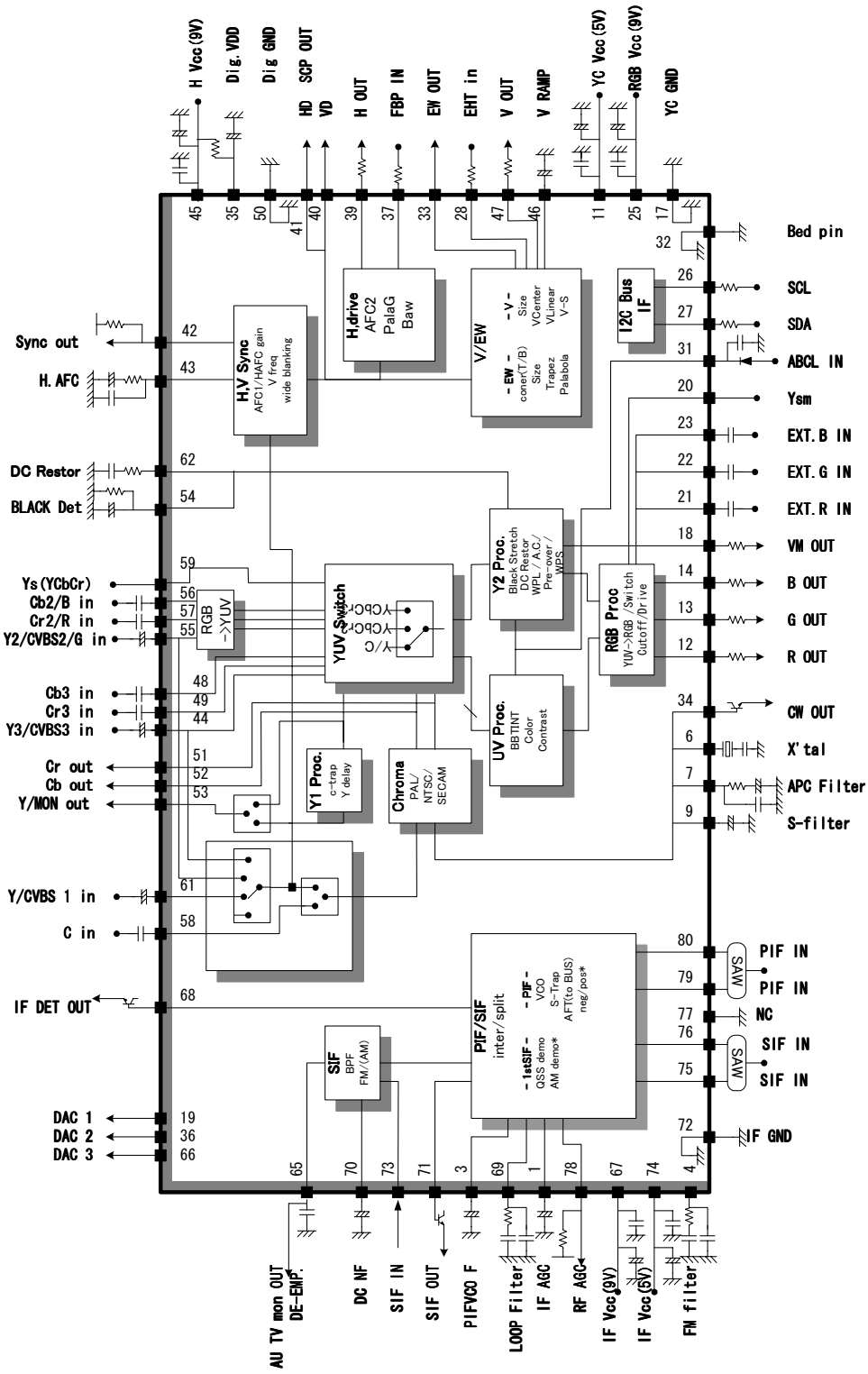

QFP 80 pin

2, BUS CONTROL MAP of the "TB1261F/62F"

[WRITE] Slave Address: 88H

	D7	D6	D5	D4	D3	D2	D1	D0		
0	WPS	Contrast							0000_0000	
1	Brn on RGB	Bright							0000_0000	
2	Col-y	Color							0100_0000	
3	Demo-P		Sharpness							0010_0000
4	Y+C sw	Tint							0100_0000	
5	(0)	Video sw	C-in sw	N-Comb	CbCr sw	Ys in	Y/Mon out		0000_0000	
6	RGB Mute	Color System		RGB>YUV	Blue Back	C-Trap	Coring		0000_0000	
7	R Cut Off							0000_0000		
8	G Cut Off							0000_0000		
9	B Cut Off							0000_0000		
0A	Drive ref	B Drive Gain							0100_0000	
0B	BLK SW	R/G Drive Gain							0100_0000	
0C	Spl/Int	PLL S	RF AGC							0000_0000
0D	PIF Freq.			S-Trap			VCO-M	SIF-in		0000_0000
0E	AFT-S	Buzz-R	Over Mod	Au-G	FM-Band	SIF-Freq.		SIF-574		0000_0000
0F	S-col feint	VM-P	VM-G		DC-Restore		Y-y Point			1010_0000
10	Y-Mute	Y-DL			ABL-SP		ABL-G			0001_0000
11	F ID	PN ID S	BPF/TOF	Shoot Balance			Black Stretch			0000_0000
12	S GP Phase		S Inhibit	S ID Sense	S-ID M	HP-Boost	L-AGC	L-SECAM		0000_0000
13	Black Adj. R-Y				Black Adj. B-Y					1000_1000
14	sync gate	F sync	312/313	H Phase						0001_0000
15	V Freq.			V Phase						0000_0000
16	VRamp Ref	V Size							1100_0000	
17	V Linearity				V-S Corr.					1000_1000
18	AFC Gain		V Cent.							0010_0000
19	H Side BLK	V BLK Bottom			V BLK Top					0000_0000
1A	RFAGC-Adj.	LAGC lim	PIF Det Lev		Noise Det Level					0100_1000
1B	V AGC	EW Para							0100_0000	
1C	dac1	H Stop	H Size						0010_0000	
1D	dac2	xxx	EW Trape						0010_0000	
1E	V. EHT			EW Corner Top					0001_0000	
1F	H. EHT			EW Corner Bottom					0001_0000	
20	dac3	DCNF	H. Par			H. Bow				0110_0100
21	TEST							0000_0000		
	Strap-HP/LP		P PLL u	S2-Q	Strap-GD		Strap-Q			0000_0000

[READ]

	D7	D6	D5	D4	D3	D2	D1	D0
R0	POR	IF Lock	H Lock	Color System			AFT-C	AFT-W
R1	V Freq.	V-STD	Noise	RFAGC	C IN DC	Sound Dev.	Station Det	PVCO-Err

3, Features comparizon for TB1261F and TB1262F

TB1261F and TB1262F are distinguished with their assured specifications for its IF systems. Basically, TB1261 is for Asian models and TB1262 is for Europeans. The comparisons are shown in the next table.

	TB1261F	TB1262F
Picture IF	- Neg. demo	- Neg. demo - Pos. demo (L/L')
Sound IF	- Split/ inter carrier - BG, DK, I, M (FM) - BG (IGR-bilingual fm)	- Split/ inter carrier - BG, DK, I (FM) - L (AM sound demo)

These difference are realized by its Bus controls. The bits marked 'n/a' in the next table should not be selected by controller micro processor , in fact they can be set but not assured.

BUS CONTROL ITEMS	BITS	CONTROLS	TB1261F	TB1262F
PIF Freq. (00) [Sub: 0Dh D7~D5 3 bits]	000	45.75 MHz	x	n/a
	001	39.5 MHz	n/a	x
	010	38.9 MHz	x	x
	011	38.0 MHz	x	n/a
	100	34.2 MHz	n/a	x
	101	33.9 MHz	n/a	x
L-SECAM (0), L-AGC(0), FM Stop [Sub: 12h D1,D0 2 bits]	00	not LSECAM, not FM stop	x	x
	01	L-SECAM	n/a	x
	10	L-SECAM & AGC speed up	n/a	x
	11	FM Stop	x	x
SIF-Freq (00) [Sub: 0Eh D1-D2 2 bits]	00	5.5MHz	x	x
	01	6.0MHz	x	x
	10	6.5MHz	x	x
	11	4.5MHz	x	n/a
SIF-574 (0) [Sub: 0Eh D0 1 bit]	0	Others	x	x
	1	5.74MHz	x	n/a

x ; can be selected

n/a ; the feature not guaranteed

4, MAXIMUM RATINGS (Ta=25°C)

ITEM	SYMBOL	RATING	UNIT
Supply Voltage (9V Vcc)	Vcc max9	12	V
Supply Voltage (5V Vcc)	Vcc max5	6.5	V
Supply Voltage (3.3V Vdd)	Vdd max3.3	5.0	V
Power Dissipation	PD max	1980(*1)	mW
Input terminal Voltage	V in	GND - 0.3 ~ Vcc + 0.3	V
Operating Temperature	Topr	-20 ~ 65	°C
Storage Temperature	Tstg	-55 ~ 150	°C

(*1) When using this device at above Ta=25°C, the power dissipation decreases by 15.9mW per 1°C rise.

(*2) This IC is weak against static electricity and surge impulse. Please take counter measure to meet, if necessary.

(*3) This IC is not proofed enough against a strong E-M field by CRT which may cause function error and/or poor characteristics. Keeping the distance from CRT to the IC longer than 20cm, or if cannot, placing shield metal over the IC, is recommended in an application.

Ta-PD Curve (on a PCB)

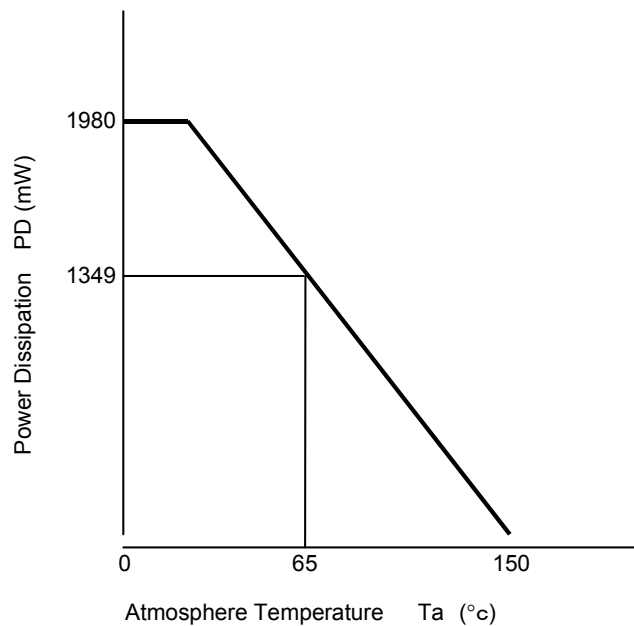

5, OPERATING POWER SUPPLY VOLTAGE

PIN NO.	PIN NAME	MIN.	TYP.	MAX.	UNIT	NOTE
74	IF Vcc (5V)	4.75	5	5.25	V	—
67	IF Vcc (9V)	8.55	9	9.45		
25	RGB VCC (9V)	8.55	9	9.45	V	—
45	H VCC (9V)	8.55	9	9.45	V	—
35	DIGITAL VDD	3.1	3.3	3.5	V	This pin should be supplied from HVcc via 270 ohms of resistor.
11	Y/C VCC (5V)	4.75	5	5.25	V	

6, DATA TRANSFER FORMAT VIA I2C BUS

Start and stop condition

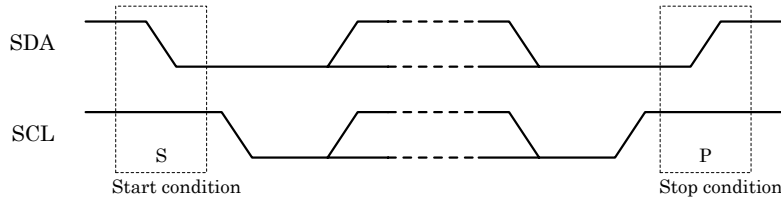

Bit transfer

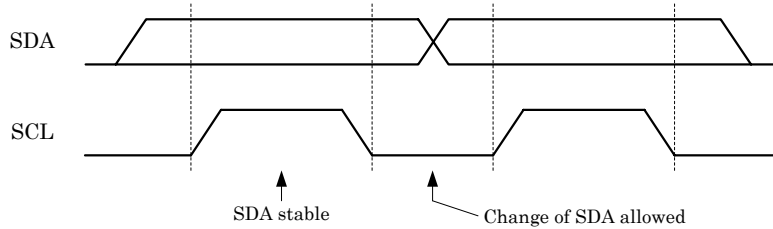

Acknowledge

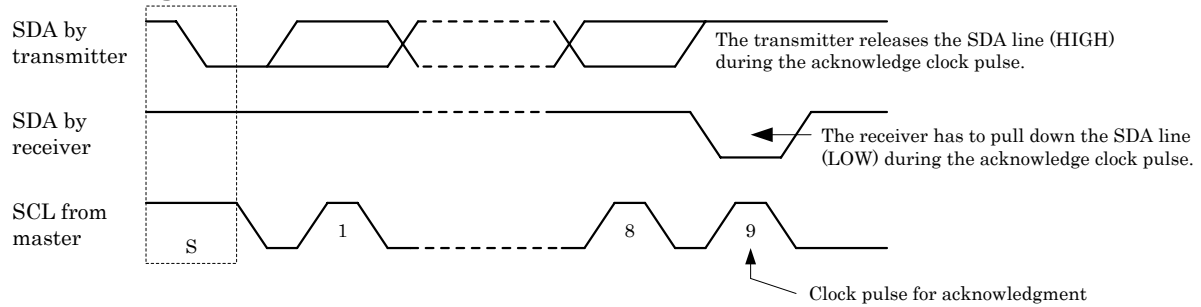

Data transmit format 1

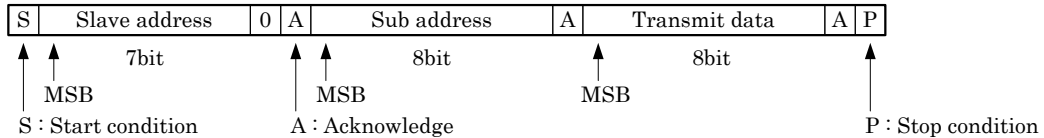

Data transmit format 2

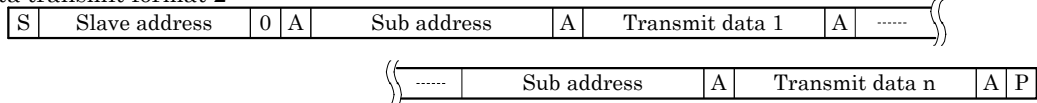

Data received format

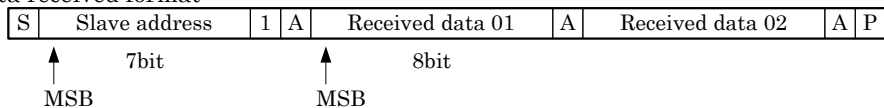

At the moment of the first acknowledge, the master transmitter becomes a master receiver and the slave receiver becomes a slave transmitter. This acknowledge is still generated by the slave. The Stop condition is generated by the master.

Optional data transmit format : automatic increment mode



In this transmission methods, data is set on automatically incremented sub-address from the specified sub-address.

Purchase of TOSHIBA I²C components conveys a license under the Philips I²C Patent Rights to use these components in an I²C system, provided that the system conforms to the I²C Standard Specification as defined by Philips.

7, Terminal Descriptions

Pin #	Description
1	IF AGC; (8) A terminal should be connected to an IF AGC filter. Connect 0.47uF of capacitor to GND. In selecting L system, the capacitor works for 1st SIF AGC.
2	nc;
3	PIF Filter; (9) A terminal to be connected to a filter for stabilizing the PIF VCO center frequency. Put a capacitor of 10 uF.
4	FM Filter; (10) A terminal should be connected to an FM PLL filter. Put a lag lead CR filter.;
5	nc;
6	Xtal (4.43MHz); (11) A terminal should be connected with a 4.433619MHz crystal oscillator. The oscillated signal leads to the chroma demodulation, H out frequency tuning, AFT, etc.;
7	APC Filter; (12) A terminal should be connected with an APC filter for chroma demodulation. This terminal voltage controls the frequency of VCXO.;
8	nc;
9	SECAM Filter; (13) The terminal should be connected a SECAM filter for holding SECAN reference frequency. Connect 0.47uF to GND, If not using SECAM decoder on TB1261, put at least 0.01uF of capacitor to GND.
10	nc;
11	Y/C VCC; (14) A Vcc terminal for Y/C circuit. Supply 5V.;
12	R OUT;
13	G OUT;
14	B OUT; (15) Terminals for R/G/B signal output, should be lead to CRT driver. Connect resistances to GND, for the current source if the slew rate is not enough. Due to the source current limitation, the resistances should be 2.0kΩ or more.;
15	nc;
16	nc;
17	Y/C GND; (18) The GND terminal for Y/C circuit.;
18	VM OUT; (19) The output terminal for applying veracity scanning modulation (VSM). The IIC Bus controls phase and Gain of VSM.;

Pin #	Description
19	DAC1; A terminal to be output High/ Low status by an open collector interface. The pull up resistance should be fixed as a sink current is 1mA or less and the pull up voltage should be less than the voltage of RGB Vcc.
20	YS/YM SW; (20) A terminal for switching of EXT RGB Mode and fast transparent. EXT. RGB 2.1V ----- Half tone 0.7V ----- TV 0V -----
21	EXT. R IN;
22	EXT. G IN;
23	EXT. B IN; Input terminals for EXT R/G/B signals. The signals are clamped by capacitors, therefore the input impedance should be low, 100 ohms or less is recommended. For this input, the brightness control with ABL is available. ABL OFF: for small area like OSD ABL ON: for large area like TELETTEXT (input level 0.7Vp-p/100IRE)
24	nc;
25	RGB VCC (9V); (24) A Vcc terminal for RGB block. Supply 9V.
26	SCL; (25) An input terminal for IICBUS clock.;
27	SDA; (26) An input/output terminal for IICBUS data.;
28	EHT IN; (27) The input terminal for EHT. The ratio of EW / V is controlled by bus.;
29	nc;
30	nc;
31	ABCL IN; (28) An input terminal for ABL/ACL control. Control voltage range is 5.0 - 6.0V. The ratio of ABL versus ACL can be set by bus control.;
32	Bed pin; QFP Connect GND. only The earth pattern should be recommended to be isolated from Def GND and connect IF GND.
33	EW OUT; (29) An output terminal for E-W OUT.
34	CW OUT; (30) An output terminal for the continuous chroma sub-carrier frequency wave, with amplitude of 0.4Vp-p (typ).

Pin #	Description
35 (31)	DIG. VDD ; A Vdd terminal for of digital block. Supply HVcc voltage through 270 ohms of resistance. The coupling capacitor should be 10uF or less, in order to keep rise up time good enough. The voltage of this terminal is clipped to approximately 3.3V by the internal regulator.
36 QFP only	Dac2; A terminal to be output High/ Low status by an open collector interface. The pull up resistance should be fixed as a sink current is 1mA or less and the voltage is less than the voltage of H Vcc.
37 (32)	FBP IN; An input terminal for FBP. V/GP pulses are output over this FBP. The Threshold levels are; 1.4 V; for Blanking 3.7 V; for HAFC2
38	nc;
39 (33)	H OUT; An output terminal for horizontal driving pulses.;
40 QFP only	VD OUT; An output terminal for VD pulses. The pulses are 3V for its level.
41 QFP only	HD OUT; An output terminal fot HD pulses. GP Pulses are overlaid as SCP. Also BPP is overlaid to stop black stretch detecting. Those levels are 5V; for GP out 3V; for HD out 0.7V; for BPP in
42 QFP only	Sync out; An output terminal of the sliced sync pulses. Pull up this pin with 5.1kΩ of resistance.
43 (34)	H AFC Filter; A terminal should be connected with H. AFC Filter. The DC voltage of this pin controls the H VCO frequency.
44 QFP only	Y3/CVBS3 IN; An alternative input terminal for; - Y + Sync signals of Y/Cb/Cr_3 - Or CVBS_3 Those two are selected by IICBUS This terminal is clamped by charging / discharging the coupling capacitors. It is recommended that input impedance is kept at or below 100Ω. Input level 1Vp-p/140IRE
45 (35)	H VCC (9V); A Vcc terminal for DEF circuit, HOUT, IICBUS POR, etc. Supply 9V.;

Pin #	Description
46 (36)	V RAMP; A terminal should be connected with a capacitor to generate the V.Ramp signal. Connect this pin to GND via 0.47uF. The V.Ramp amplitude is kept constant by the V.AGC.;
47 (37)	V OUT; An output terminal for the vertical saw tooth wave.
48 49 QFP only	Cb3 IN; Cr3 IN; Input terminals for ; - Cb and Cr signals of Y/Cb/Cr_3 These terminals are clamped by charging / discharging the coupling capacitors. It is recommended that input impedance is kept at or below 100Ω.
50 (38)	DIG GND; A GND terminal for digital block.;
51 52 (39) (40)	Cr OUT; Cb OUT; Output terminals for demodulated Cb and Cr signals.
53 (41)	Y/Mon OUT An alternative output terminal for; - Y signal after Y1 process - Or Mon out after selector Those two are selected by IICBUS
54 (42)	BLACK DET; A terminal should be connected with Black level detecting filter for black stretch. This terminal voltage controls the Black stretching gain. The IIC Bus controls the on/off and start point of the Black stretch. ;
55 (43)	Y2/CVBS2/G IN An alternative input terminal for; - Y + Sync signals of Y/Cb/Cr_2 in - Or CVBS_2 - Or G signal of Scart Y/R/G/B in Those three are selected by IICBUS. These terminals are clamped by charging / discharging the coupling capacitors. It is recommended that input impedance is kept at or below 100Ω.
56 57 (44) (45)	Cb2/B IN; Cr2/R IN; Alternative input terminals for; - Cb and Cr signals of Y/Cb/Cr_2 - Or R and B signal of Scart Y/R/G/B in Those three are selected by IICBUS These terminals are clamped by charging / discharging the coupling capacitors. It is recommended that input impedance is kept at or below 100Ω.
58 (46)	C-IN; An input terminal for chroma signal (standard burst amplitude level 286mVp-p). The dc level of this pin can be read by bus to detect if S port is connected or not.;

Pin #	Description
59 (47)	Ys(YCbCr) A fast switch for selecting Y/Cb/Cr2 in (or fast blanking for scart R/G/B in). Forced Y/Cb/Cr (or scart R/G/B in) 0.7V ----- Selecting by IICBUS 0V -----
60	nc;
61 (48)	Y/CVBS1 IN An alternative input terminal for; - Y + Sync signals of Y/C - Or CVBS_1 Those two are selected by IICBUS This terminal is clamped by charging / discharging the coupling capacitors. It is recommended that input impedance is kept at or below 100Ω. Input level 1Vp-p/140IRE
62 (49)	DC RESTOR; A terminal to be connected with a capacitor to detect the average picture level for DC restoration. The ratio of the DC restoration is set by bus. Leave this terminal open if the DC restoration is not required. ;
63	nc;
64	nc;
65 (50)	De-Emphasis/Mon-OUT; A terminal to De-Emphasis Audio signal, and pick up detected Audio signal. Connect capacitor (4700pF) to GND. The time constant 50/75us is set by the IICBUS control "SIF Freq". Remove the capacitor for connecting US/JPN sound multiplex system.
66 QFP	DAC 3; A terminal to be output High/ Low status by an open collector interface. The pull up resistance should be fixed as a sink current is 1mA or less and the voltage is less than the voltage of IF Vcc.
67 (51)	IF Vcc(9V); A Vcc terminal for Y/C circuit. Supply 9V;
68 (52)	IF DET OUT; Detected PIF output terminal.(typical output level 2.2Vp-p)

Pin #	Description
69 (53)	LOOP Filter; A terminal to be connected with loop filter for PIF PLL. The terminal voltage controls the PIF VCO frequency.;
70 (54)	DC NF; A terminal for connecting a capacitor for DC NF. This filter is very sensitive for the Audio quality; therefore connect capacitor to a stable GND point. In selecting L system, the capacitor works for PIF AGC filter.
71 (55)	SIF OUT; An output terminal for a 2'nd SIF signal, which is mixed down by a regenerated carrier.
72 (56)	IF GND; The GND terminal for IF circuit.;
73 (1)	SIF IN / H corr.; An input terminal for 2'nd SIF signal and H. curve correction.
74 (2)	IF VCC (5V); A Vcc terminal for the IF circuit. Supply 5V.;
75 (3)	1'st SIF IN(1); Input terminals for 1'st SIF signals.
76 (4)	1'st SIF IN(2); If not using Split input, leave these pins open, and turn the IICBUS bit of "Spl/ Int" [s0C/d7] to "1"
77	Nc (to GND); Connect this pin to GND to isolate PIF and 1stSIF input.
78 (5)	RF AGC; An output terminal for RF AGC. A pull up resistor is required because of its open collector output. A de-coupling capacitor should be also connected to adjust the response.
79 (6)	IF IN(1);
80 (7)	IF IN(2); Input terminals for IF signals. Pin 6 and 7 are the both input poles of a differential amplifier. The normal input level is 90dB(uV); input impedance is 1.5 k ohms.

8, Interfaces

1: IF AGC

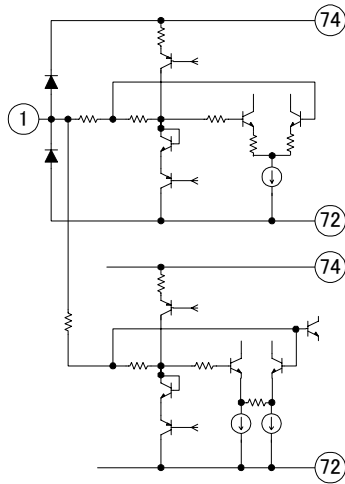

7: APC Filter

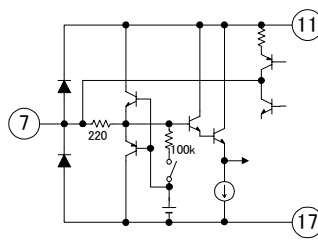

20: Ysm

22: EXT. G IN

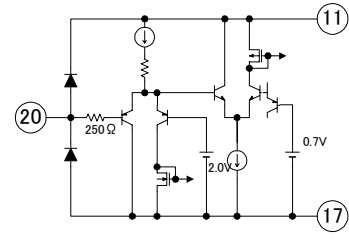

9: S-filter

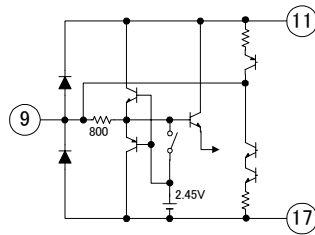

**21: EXT. R IN
23: EXT. B IN**

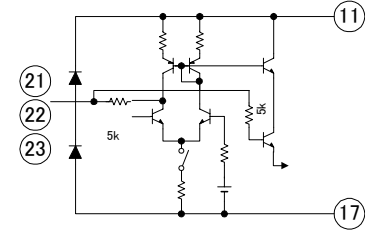

3: PIF filter

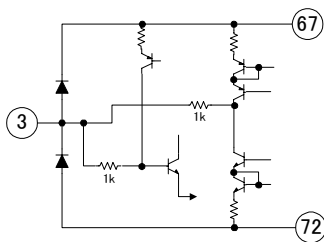

**12: R OUT 13: G OUT
14: B OUT**

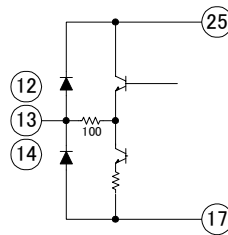

26: SCL

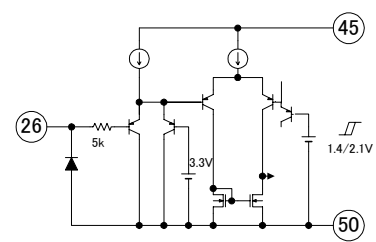

4: FM filter

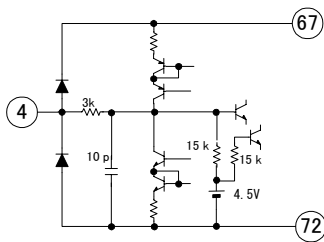

18: VM OUT

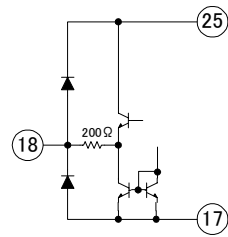

27: SDA

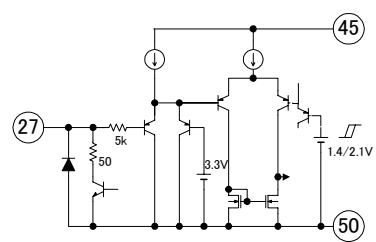

6: X' tal

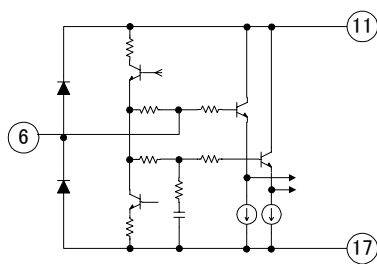

19: DAC 1

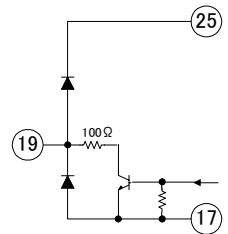

28: EHT in

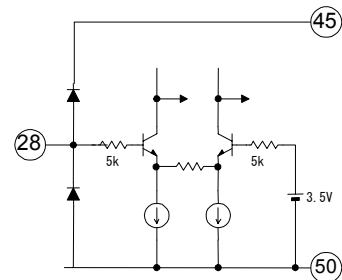

31: ABCL IN

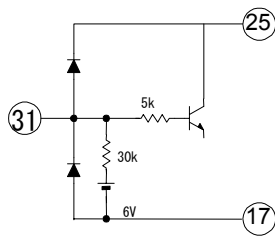

39: H OUT

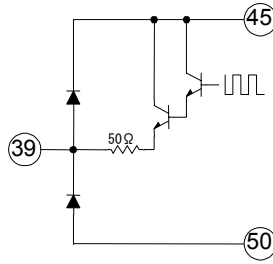

44: Y3/CVBS3 in

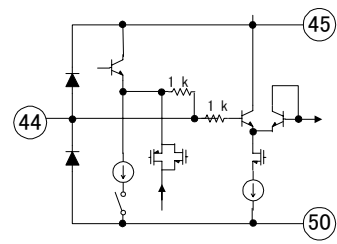

33: EW OUT

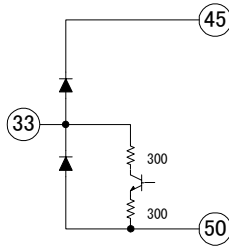

40: VD

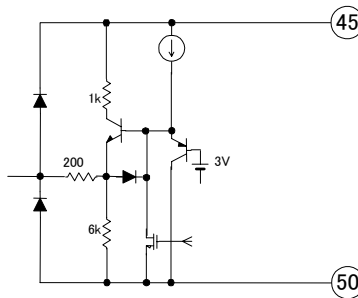

46: V RAMP

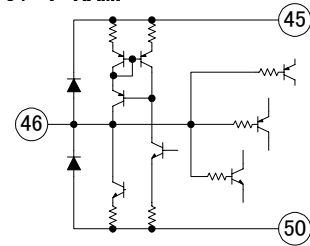

34: CW OUT

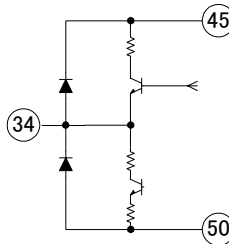

41: HD/SCP OUT

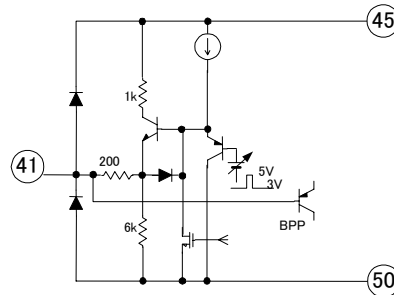

47: V OUT

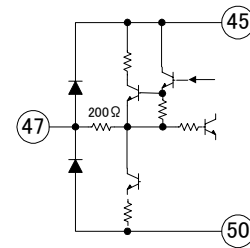

36: DAC 2

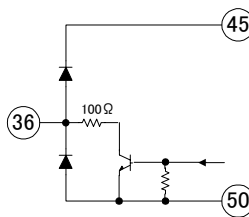

42: Sync out

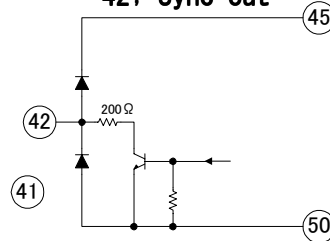

48: Cb3 in 49: Cr3 in

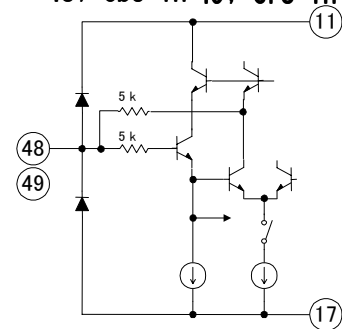

37: FBP IN

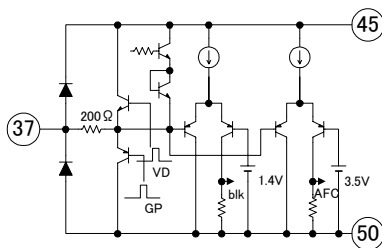

43: H. AFC

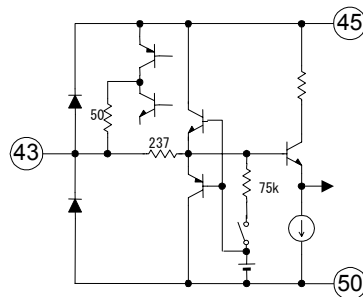

51: Cr out 52: Cb out

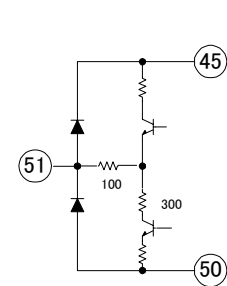

53: Y/MON out

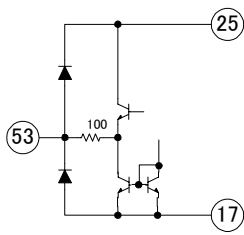

59: Ys (YCbCr)

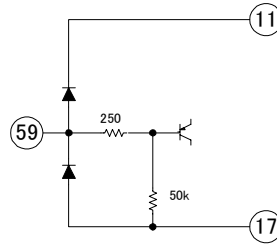

68: IF DET OUT

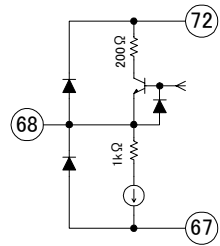

54: BLACK Det

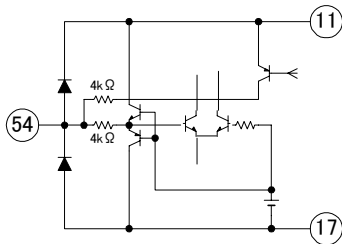

61: Y/CVBS 1 in

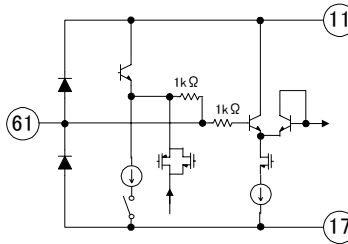

69: LOOP Filter

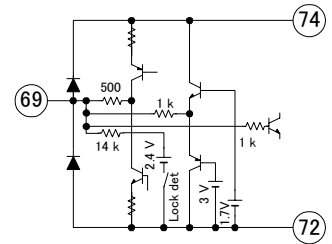

55: Y2/CVBS2/G in

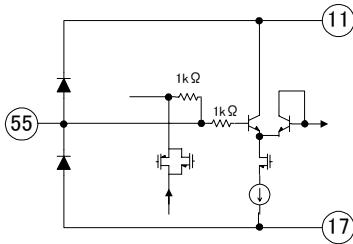

62: DC Restor

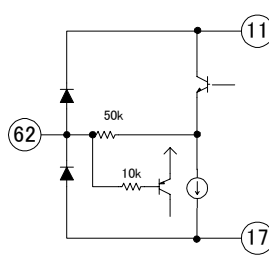

70: DC NF/AM AGC

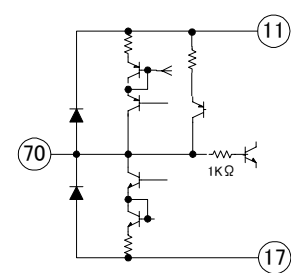

56: Cb2/B in 57: Cr2/R in

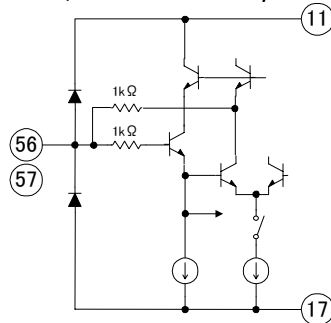

65: DE-EMP. AUDIO OUT

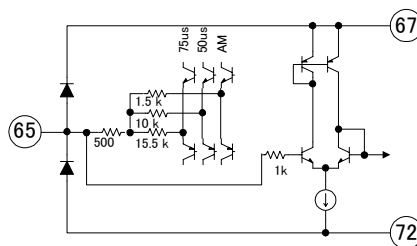

58: C in

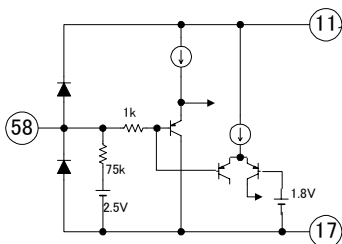

66: DAC 3

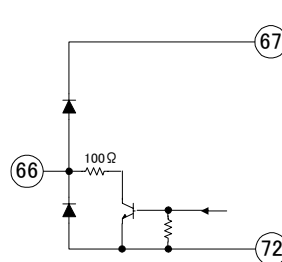

71: SIF OUT

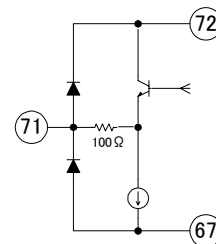

73: SIF IN

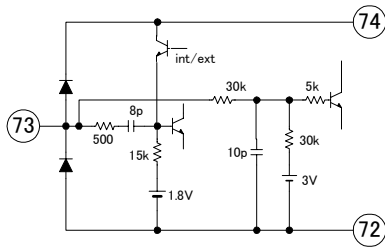

78: RF AGC

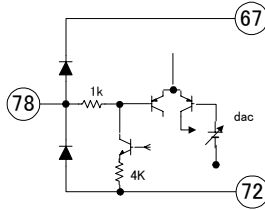

**79: PIF IN
80: PIF IN**

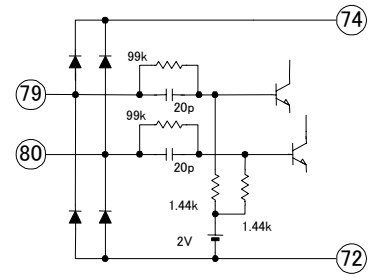

75: SIF IN 76: SIF IN

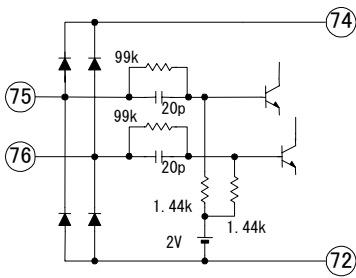

9, BUS Description

WRITE MODE

[PIF]

RF AGC (00) [Sub: 0Ch D5~D0 6 bits]

Data	Descriptions
00	IF mute Stops Demodulation
01	65dB(uV)
3F	105 dB(uV)

RF AGC delay point (Pin6-7)

PIF Freq. (00) [Sub: 0Dh D7~D5 3 bits]

Data	Descriptions
000	45.75 MHz
001	39.5 MHz
010	38.9 MHz
011	38.0 MHz
100	34.2 MHz
101	33.9 MHz

Setting IF frequency according to tuner frequency. It fixes the VCO frequency and AFT center frequency.

VCO-M (0) [Sub: 0Dh D1 1 bit]

Data	Descriptions
0	Absolute (duration of searching)
1	Relative (normal)

VCO tuning mode

TB1261 has two VCO tuning mode, which are 'Absolute' and 'relative'. The 'Absolute' mode refers the crystal oscillation frequency 4.43MHz, the 'Relative' mode refers the IF input frequency, which is tuned by AFT loop.

Set 'Relative' mode in normal receiving, and 'Absolute' in channel searching. Even setting the 'Relative' mode, the VCO mode works as 'Absolute' in status of 'PIF Unlock' automatically.

AFT-S (0) [Sub: 0Eh D7 1 bit]

Data	Descriptions
0	Wide 400kHz
1	Narrow 100kHz

The range of the AFT-W read.

Over Mod (0) [Sub: 0Eh D5 1 bit]

Data	Descriptions
0	Off (recommended)
1	On

on/off the over modulation switch

The measure circuit against over modulation stops the APC in detecting the over modulation, in order to avoid folding the detected signal. It may cause, however, malfunction against the phase modulated RF signals. So evaluate carefully in using this function.

PLL-S (0) [Sub: 0Ch D6 1 bit]

Data	Descriptions
0	Normal (recommended)
1	speed-up (x2)

PLL Sensitivity. Set always '0; normal'

Buzz-R (0) [Sub: 0Eh D6 1 bit]

Data	Descriptions
0	On (recommended)
1	Off

Nyquist Buzz Reducer SW.

PIF Det lev (4) [Sub: 1Ah D5~D4 2 bits]

Data	Descriptions
0	Min
3	Max

PIF detected output level trimming

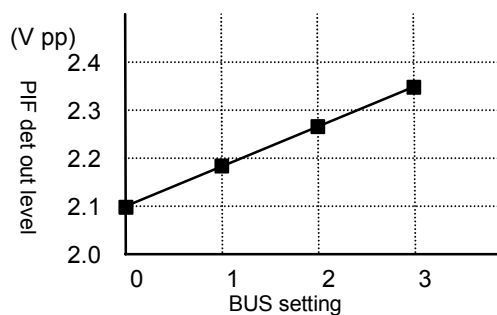

Graph PIF det out level

L-SECAM (0), L-AGC(0), FM Stop

[Sub: 12h D1,D0 2 bits]

D1	D0	Descriptions
0	0	not LSECAM, not FM stop
0	1	L-SECAM
1	1	L-SECAM & AGC speed up
1	0	FM Stop

{L-SECAM}

Selecting the IF mode to the L-system or not.

This mode is available only for the TB1262. This bit set to L-system as to:

- Turn the modulation polarity to positive
- Delay the AGC time constant (Peek AGC), with switching the IF AGC filter to the capacitor of DCNF pin (10uF) instead of IFAGC pin (0.47uF) .
- SIF AM demodulation (Split carrier only) with switching the SIF AGC filter to the capacitor of IFAGC pin (0.47uF) .

{L-SECAM AGC speed up}

Speed up the AGC response for channel search

{FM Stop}

Stopping the FM demodulator to use in NICAM demodulation.

S-Trap(100) [Sub: 0Dh D2-D4 3 bits]

Data	Descriptions
000	S-trap Off
001	fo tuning min
111	fo tuning max

Trap fo tuning and on/off switch. Need to set the tuning data for each sound system.

Strap-Q (00) [Sub: 22h D1-D0 2 bits]

Data	Descriptions
00	Q = 3
01	Q = 5
10	Q = 7 (recommended)
11	Q = 9

Sound trap Q control. Need to set the tuning data for each sound system.

Strap-GD (00) [Sub: 22h D1-D0 2 bits]

Data	Descriptions
00	off
01	60 ns
10	90 ns
11	120 ns

Sound trap Group delay control. Need to set the tuning data for each sound system.

LGC-lim [Sub: 1Ah D6 1 bit]

Data	Descriptions
0	on
1	off

AGC limiter for L system. It works when set L system.

PIF PLL u [Sub: 22h D5 1 bit]

Data	Descriptions
0	normal
1	1/3

Reduce the u of the PIF PLL

S trap-HP LP (00) [Sub: 22h D7-D6 2 bits]

Data	Descriptions
00	off
01	1 dB (HPF)
10	- 3 dB (LPF)
11	- 2 dB (LPF)

Frequency response control. Need to set the tuning data for each sound system

S2-Q [Sub: 22h D4 1 bit]

Data	Descriptions
0	normal
1	fixed Q=3 for S2 trap

RFAGC-adj [Sub: 1Ah D7 1 bit]

Data	Descriptions
0	Normal
1	adjusting mode

RF AGC delay point adjusting mode. See ***.

[SIF]

SIF-Freq (00) [Sub: 0Eh D1-D2 2 bits]

Data	Descriptions
00	5.5MHz
01	6.0MHz
10	6.5MHz
11	4.5MHz

Set the SIF frequency for BPF

Set the SIF frequency for Trap filter

Select the SIF FM demodulator band

select the de-emphasis speed

SIF-574 (0) [Sub: 0Eh D0 1 bit]

Data	Descriptions
0	Others
1	5.74MHz

To use this bit, an external BPF of 5.74MHz is required

Au-G (0) [Sub: 0Eh D4 1 bit]

Data	Descriptions
0	927mVrms at 25kHz/DEV
1	500mVrms at 25kHz/DEV

Audio Gain Switch for M system

FM-band (0) [Sub: 0Eh D3 1 bit]

Data	Descriptions
0	Wide
1	Narrow

Select FM band width

It controls the bandwidth or pull-in range of the FM demodulator. This bit should be set depending on the region as to put wide/narrow bandwidth ceramic BPF.

SIF-in (0) [Sub: 0Dh D0 1 bit]

Data	Descriptions
0	Internal
1	External

Select 2nd SIF limiter input path. External BPF is required in selecting 'External'.

Sp/ Int (0) [Sub: 0Ch D7 1 bit]

Data	Descriptions
0	Split carrier
1	Inter carrier

Split carrier / Inter carrier selecting.

DCNF (1) [Sub: 20h D6 1 bit]

Data	Descriptions
0	Normal
1	Speed up

DCNF Speed. Need to set '1 speed up' at least 500ms after power on.

[YUV, RGB]

- Y1

Y-DL (001) [Sub; 10h D4-D6 3 bits]

Data	Descriptions
000	-120ns
001	-80ns
010	-40ns
011	+0ns
100	+400ns
101	+80ns
110	+120ns
111	+160ns

Y Delay time

C-Trap (0) [Sub; 06h D1 1 bit]

Data	Descriptions
0	Off: for Y / C Separated input
1	On: for internal C trap (-20dB or less)

Chroma trap filter for Y input

- Y2

Black Stretch (00) [Sub; 11h D0-D1 2 bits]

Data	Descriptions
00	Off
01	25IRE
10	35IRE
11	45IRE

Set the black stretch start poin.

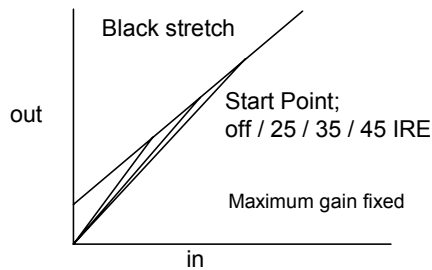

DC-Restor. (00) [Sub; 0Fh D2-D3 2 bits]

Data	Descriptions
00	120%
01	90%
10	100%
11	110%

DC Restoration control

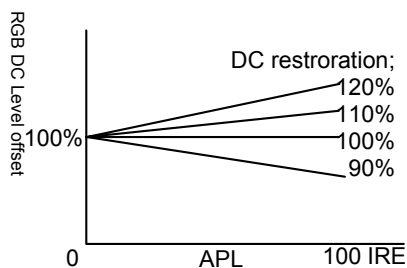

Y-γ point (00) [Sub; 0Fh D1-D0 2 bits]

Data	Descriptions
00	Off
01	90IRE
10	80IRE
11	70IRE

Set the point of non linear curve for Y signal

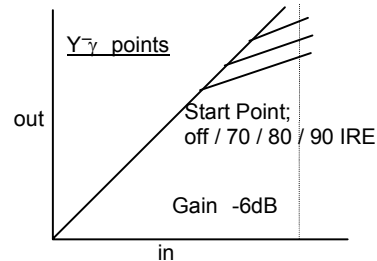

Sharpness (20) [Sub; 03h D5-D0 6 bits]

Data	Descriptions
00	-5.9dB
20	3.7dB
3F	5.0 dB

Sharpness control peak:4MHz

Shoot balance (00) [Sub; 11h D4-D2 3 bits]

Data	Descriptions
0	pre
7	over

shoot balance control

coring (0) [Sub; 06h D0 1 bit]

Data	Descriptions
0	On
1	Off

on/off the coring

WPS (0) [Sub; 00h D7 1 bit]

Data	Descriptions
0	On
1	Off

White Peak Suppressor Switch

VM-P (0) [Sub; 0Fh D6 1 bit]

Data	Descriptions
0	-120ns
1	-60ns

VSM output phase switching

VM-G (10) [Sub; 0Fh D4-D5 2 bits]

Data	Descriptions
00	- 10dB
01	- 3dB
10	0dB
11	Off

VSM output gain switching

- UV

TINT (40) [Sub; 04h D6-D0 7 bits]

Data	Descriptions
00	-35°
7F	35°

Tint control (Base Band TINT)

Black Adj. R-Y (4) [Sub; 13h D7-D4 4 bits]

Black Adj. B-Y (4) [Sub; 13h D3-D0 4 bits]

Data	Descriptions
0	-92 mV
F	+85mV 14mV/dev

UV Black level adjust

Color (40) [Sub; 02h D6-D0 7 bits]

Data	Descriptions
00	-20 dB or less
7F	6.5 dB

Color control

DEMO-P (00) [Sub; 03h D6-D7 2 bits]

Data	Descriptions
00	PAL1
01	PAL2
10	NTSC1 (105°)
11	NTSC2 (95°)

the relative phase / amplitude

The relative amplitude and phase are fixed as the following table. The setting are depend on only IICBUS command, so that a set micro computer should select DEMO-P mode on read out 'Color system' in changing the phase on received color system.

Table The relative amplitude and phase

		BUS mode	00 PAL1	01 PAL2	10 NTSC 1	11 NTSC 2
		Relative Amplitude	R-Y/B-Y	0.55	0.78	0.79
	G-Y/B-Y	0.33	0.33	0.28	0.33	
Relative Phase	R-Y/B-Y	90	90	105	105	
	G-Y/B-Y	240	240	246	237	
CbCr out	Cr out	330mVpp / 90 deg				
	Cb out	330mVpp / 0 deg				

Col-γ (0) [Sub; 02h D7 1 bit]

Data	Descriptions
0	Off
1	On

on/off the color γ on R

- YUV

Contrast (00) [Sub; 00h D6-D0 7 bits]

Data	Descriptions
00	DB
7F	-24dB

contrast control

ABL-SP (00) [Sub; 00h D3-D2 2 bits]

Data	Descriptions
00	0V
01	-0.20 V
10	-0.30 V
11	-0.50 V

Selecting ABL start point

ABL-G (00) [Sub; 00h D1-D0 2 bits]

Data	Descriptions
00	-0.21 V
01	-0.38 V
10	-0.50 V
11	-0.67 V

ABL Gain control

Y-Mute (0) [Sub; 10h D7 1 bit]

Data	Descriptions
0	Off
1	On

on / off the Y MUTE

RGB

Bright (00) [Sub; 01h D6-D0 7 bits]

Data	Descriptions
00	1.75 V (Pedestal Level)
7F	3.25 V (Pedestal Level)

Brightness control

Brt on RGB (0) [Sub 01h D7 1 bit]

Data	Descriptions
0	RGB Brt on
1	RGB Brt off

Brightness on RGB input

Blue Back (0) [Sub; 06h D2 1 bit]

Data	Descriptions
0	Off
1	on (50 IRE)

Blue Back Switch

R Cutoff (00) [Sub; 07h D7-D0 8 bits]

G Cutoff (00) [Sub; 08h D7-D0 8 bits]

B Cutoff (00) [Sub; 09h D7-D0 8 bits]

Data	Descriptions
00	-0.65 V
FF	0.65 V

R,G,B Cutoff control

B Drive (40) [Sub; 0Ah D6-D0 7 bits]

R/G Drive (40) [Sub; 0Bh D6-D0 7 bits]

Data	Descriptions
00	-5.5 dB
7F	3.5 dB

R/G, B Drive control

Drive ref (0) [Sub: 0Ah D7 1 bit]

Data	Descriptions
0	R reference (G active)
1	G reference (R active)

Drive control reference

Blk (0) [Sub: 0Bh D7 1 bit]

Data	Descriptions
0	Blanking on (normal mode)
1	Blanking off

Hor. And Vert. blanking for RGB outputs

RGB-M (1) [Sub: 06h D7 1 bit]

Data	Descriptions
0	Off
1	On (-20 IRE)

on / off the RGB mute

[CHROMA STAGE]

Color System (000) [Sub: 06h D6-D4 3 bits]

Data	Descriptions
000	Auto 1 (for Eu, Asia,,,) 443PAL, 358NTSC, SECAM, 443NTSC
001	Auto 2 (for S-America) 358NTSC, M-PAL, N-PAL
010	Fixed 358NTSC
011	Fixed 443NTSC
100	Fixed 443PAL
101	Fixed SECAM
110	Fixed M PAL
111	Fixed N PAL

Color system selection

N-Comb (0) [Sub: 05h D3 1 bit]

Data	Descriptions
0	Off
1	On

Comb filter for base-band color signal of NTSC

BPF/TOF (0) [Sub: 11h D5 1 bit]

Data	Descriptions
0	BPF
1	TOF

Select chroma BPF frequency response

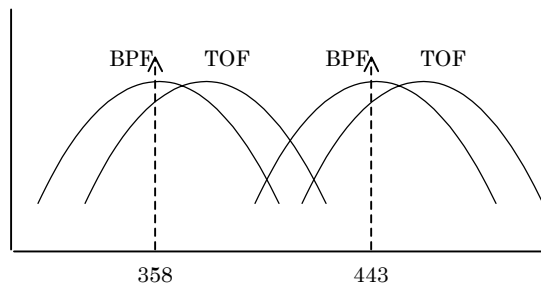

P/N ID S (0) [Sub: 11h D6 1 bit]

Data	Descriptions
0	Normal
1	Low

PAL / NTSC ID sensitivity for digital comb filter

F ID (0) [Sub: 11h D7 1 bit]

Data	Descriptions
0	Normal
1	always color on on a fixed color systems

Forced killer off (This function dose not work on Auto 1 and Auto 2 mode)

SGP (00) [Sub: 12h D7-D6 2 bits]

Data	Descriptions
00	Auto
01	+500ns (delayed)
10	center
11	-500ns (forwarded)

SECAM Gate pulse phase

S- inhibit (0) [Sub: 12h D5 1 bit]

Data	Descriptions
0	Normal
1	SECAM inhibit

SECAM inhibit

S-ID S (0) [Sub: 12h D4 1 bit]

Data	Descriptions
0	Normal
1	Low

SECAM ID Sensitivity

S-ID M (0) [Sub: 12h D3 1 bit]

Data	Descriptions
0	H * recommended
1	H+V

SECAM ID mode

HP Boost (0) [Sub: 12h D2 1 bit]

Data	Descriptions
0	Normal
1	Boost

Enhance the higher side of SECAM Bell filter, to eliminate cross color

S-col-feint (0) [Sub: 0Fh D7 1 bit]

Data	Descriptions
0	on; for RF in
1	off; for AV in

On / off the SECAM color feinting feature, which decrease color gain on RF level.

[DEF]

V Phase (00h) [Sub: 15h D4-D0 5 bits]

Data	Descriptions
0	(0H)
31	(31H)

Vertical Position control by delaying the V-ramp timing

H Phase (10h) [Sub: 14h D4-D0 5 bits]

Data	Descriptions
00	-3us
1F	3us

Horizontal Position control

V-Freq (000) [Sub: 15h D7-D5 3 bits]

Data	Descriptions
000	Auto
001	50 Hz
010	60 Hz
011	50Hz in no input
100	Forced 312.5 H, stopped V pull-in
101	Forced 262.5 H, stopped V pull-in
110	Forced 313 H, stopped V pull-in
111	Forced 263 H, stopped V pull-in

Vertical frequency pull-in mode selection

AFC Gain (00) [Sub: 18h D7-D6 2 bits]

Data	Descriptions
00	Normal
01	1 / 3 sensitivity
10	X 3 at V blanking duration
11	AFC OFF

AFC gain

Sync gate (0) [Sub: 14h D7 1 bit]

Data	Descriptions
0	Normal
1	Gated

F sync (0) [Sub: 14h D6 1 bit]

Data	Descriptions
0	Normal ; for input from RF
1	F sync ; for input from AV equipments

Forced sync

H STOP (0) [Sub: 1Ch D6 1 bit]

Data	Descriptions
0	Normal
1	& Y-mute & RGB mute; H STOP

H OUT stop

312/313 (0) [Sub: 14h D5 1 bit]

Data	Descriptions
0	Normal
1	TELETXT(312/313)

(This function makes V-scanning non-interlace for teletext)

V-AGC (1) [Sub: 1Bh D7 1 bit]

Data	Descriptions
0	Normal
1	Speed up (x3)

V Size (40h) [Sub: 16h D6-D0 7 bits]

Data	Descriptions
00	V Stop
01	-47 %
7F	47 %

Vertical size alignment / Vstop

V Linearity (4h) [Sub: 17h D7-D4 4 bits]

Data	Descriptions
0	-12 %
F	12 %

V linearity alignment

V cent. (10h) [Sub: 18h D5-D0 6 bits]

Data	Descriptions
0	-12 %
3F	12 %

V centering

V-S Corr (4h) [Sub: 17h D3-D0 4 bits]

Data	Descriptions
0	20 %
F	-12 %

V Ramp Ref. (0) [Sub: 16h D7 1 bit]

Data	Descriptions
0	External (YC Vcc)
1	Internal

Select the reference voltage

V.EHT (0h) [Sub: 1Eh D7-D5 3 bits]

Data	Descriptions
0	Min (0 %)
7	Max gain (-9 %)

Adjust the sensitivity for V

H Size (10) [Sub: 1Ch D5-D0 5 bits]

Data	Descriptions
00	700 uA
3F	0 uA (at top)

Adjust the H size by biasing the EW DC voltage

EW Para (40) [Sub: 1Bh D6-D0 7 bits]

Data	Descriptions
00	0 uA(p-p)
7F	440 uA(p-p)

Adjust the EW Parabola amplitude

EW Corner Top (10) [Sub: 1Eh D4-D0 5 bits]

Data	Descriptions
00	720 μ A (-36%)
1F	160 μ A (36%)

Adjust upper EW corner

EW Corner Bottom (19) [Sub: 1Fh D4-D0 5 bits]

Data	Descriptions
00	720 μ A (-36%)
1F	160 μ A (36%)

EW Trape (20) [Sub: 1Dh D5-D0 6 bits]

Data	Descriptions
00	- 6.5 %
1F	6.5 %

Adjusting EW trapezium

V BLK Bottom (0h) [Sub: 19h D6-D4 3 bits]

Data	Descriptions
0	Normal
7	80 %

Lower V Blanking for RGB outs

V BLK top (0h) [Sub: 19h D3-D0 4 bits]

Data	Descriptions
0	Normal
F	85 %

Upper V Blanking for RGB outs

H Side BLK (0) [Sub: 19h D7 1 bit]

Data	Descriptions
0	Off
1	on (92%)

H side Blanking

H bow (4) [Sub: 20h D2-D0 3 bits]

Data	Descriptions
0)) - 1 μ S
7	((+ 1 μ S

H Bow curve correction

H Par (4) [Sub: 20h D5-D3 3 bits]

Data	Descriptions
0	\ \ -/+ 2 μ S
7	/ / +/- 2 μ S

H Parallelogram correction

H.EHT (0) [Sub: 1Fh D7-D5 3 bits]

Data	Descriptions
0	Min (0 %)
7	Max

Adjust the sensitivity for H EHT

[OTHERS]

noise det (4) [Sub: 1Ah D3-D0 4 bits]

Data	Descriptions
0	
F	

Noise det level setting

Dac 1 (0) [Sub: 1Ch D7 1 bit]

Dac 2 (0) [Sub: 1Dh D7 1 bit]

Dac 3 (0) [Sub: 20h D7 1 bit]

Data	Descriptions
0	High impedance
1	Low

TEST (00) [Sub: 21h D7-D0 8 bits]

Data	Descriptions
00	Normal
others	For testing IC

Leave these bits preset data ; 0000 0000 0

IO selection

switch [A]

Video sw (00) [Sub; 05h D6-D5 2 bits]
 Y/mon out (0) [Sub; 05h D0 1 bit]

Data		Descriptions
Y/mon out	Video sw	
1	00	V1
	01	V2
	10	V3
	11	inhibit
0	**	V1

V2 cannot select in using RGB>YUV mode
 V3 is available only for QFP version

switch [B]

C in sw (0) [Sub; 05h D4 1 bit]

Data	Descriptions
0	Vsw out for CVBS in
1	C-in for Y/C in

switch [C]

Y+C sw (0) [Sub; 04h D7 1 bit]

Data	Descriptions
0	Through
1	Y+C

switch [D]

Y/mon out (0) [Sub; 05h D0 1 bit]

Data	Descriptions
0	Y out
1	Mon out

switch [E]

CbCr sw (0) [Sub; 05h D2 1 bit]
 Video sw (00) [Sub; 05h D6-D5 2 bits]
 Ys(CbCr) Pin# 59

Data			Descriptions
CbCr	Video	Ys	
0	*	Low	YUV 1
1	00/01	Low	YUB 2
1	10/11	Low	YUV 3
*	**	High	YUV 2

switch [F]

RGB->YUV (0) [Sub; 06h D3 1 bit]

Data	Descriptions
0	RGB in (RGB->YCbCr sw on)
1	YCbCr in

RGB->YCbCr sw

switch [G]

Ys in (0) [Sub; 05h D1 1 bit]

Data	Descriptions
0	Activate
1	Prohibited

Fig. TB1261F Switch box

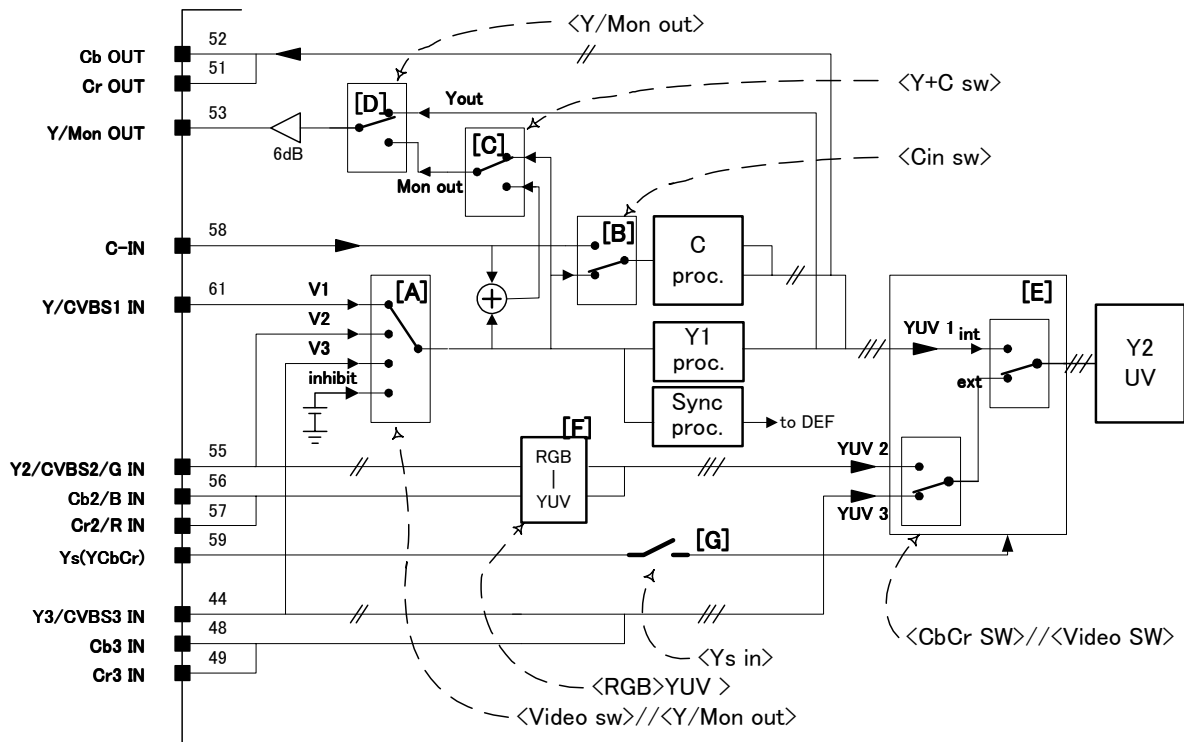

READ MODE

! General warning

The read bus flags indicate that a certain signal is detected at the moment. But reliability of detection result is not so accurate if checking only one flag, that confirming several flags, which means similar result by each other, at the same time is recommended.

POR

Data	Descriptions
0	After the first bus accessed, always 0
1	A reset condition occurred just before

IF Lock

Data	Descriptions
0	IF PLL lock detection, locked out
1	Locked in

This bit shows the locked/unlocked status of PIF PLL.

H Lock

Data	Descriptions
0	Horizontal sync lock detection, Lock out
1	Lock in

The 'H Lock' indicates whether H sync pulses are within the certain windows which generated by H counter.

Color System

Data	Descriptions
0 0 0	No color
0 0 1	4.43 PAL
0 1 0	M-PAL
0 1 1	N-PAL
1 0 0	358 NTSC
1 0 1	443 NTSC
1 1 0	SECAM
1 1 1	N/A

AFT-W

Data	Descriptions
0	Out of the AFT window
1	In the AFT window

AFT-C

Data	Descriptions
0	Upper frequency
1	Lower frequency

V Freq

Data	Descriptions
0	50 Hz
1	60 Hz

Vertical oscillation frequency.

V-STD

Data	Descriptions
0	Non standard vertical frequency
1	Standard vertical frequency

Vertical synchronization pulse is within the window of 0.625H from 312.5/262.5, or not.

Noise

Data	Descriptions
0	Lower noise level than reference voltage
1	Larger

It shows the noise level on H sync pulse. The slice level is set by 'Noise det' of IICBUS.

The detected result is hold one H period after every H sync periods. Decide the result with the majority of several readings.

RF AGC 1

Data	Descriptions
0	High
1	Low

This bit can show the DC voltage for RF AGC pin.

C-in DC

Data	Descriptions
0	Cin voltage not GND
1	GND

The DC voltage on C-in terminal. It is to detect S-jack switch status with external circuit.

Sound dev

Data	Descriptions
0	within the range (of 300%)
1	out of range

'Sound dev' detects over deviation of the SIF, which set to '1' in detecting the frequency offset of more than 157kHz, or 300%.

The detected result is hold until the first 'read' is commanded by means of S/R latch, and reset to '0' after that. Decide the result with the majority of several readings.

Station det

Data	Descriptions
0	No-Signal
1	Tuned

This bit shows the status whether the FM PLL is locked or unlocked. However it may not work so accurate for field signal, that use other parameters to control sound system.

P VCO err

Data	Descriptions
0	Ok
1	error detect

This bit is only for evaluation.

EW control

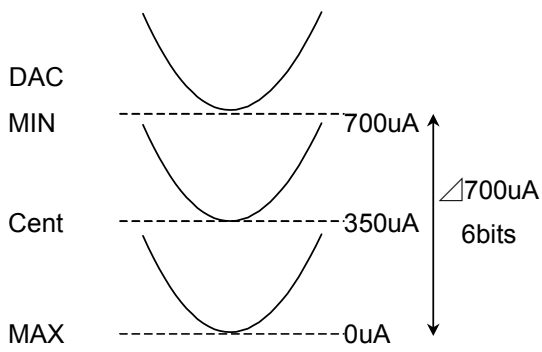

H Size

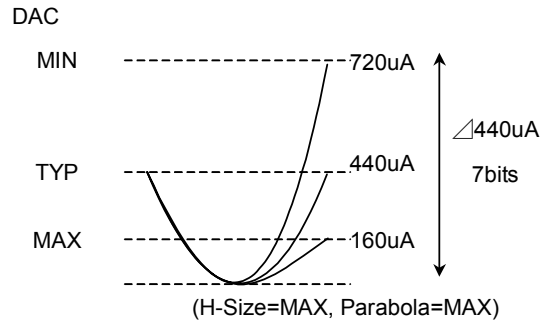

Coner (bottom)

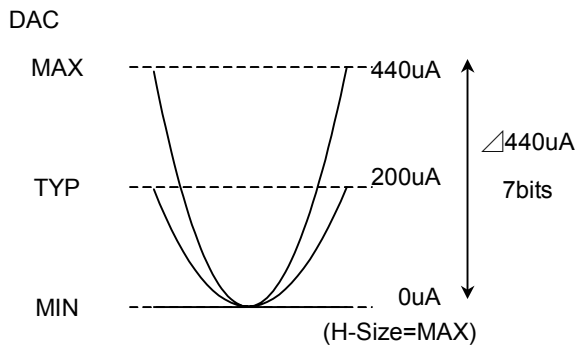

Parabola

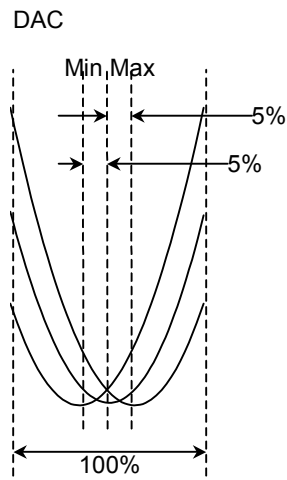

Trapezium

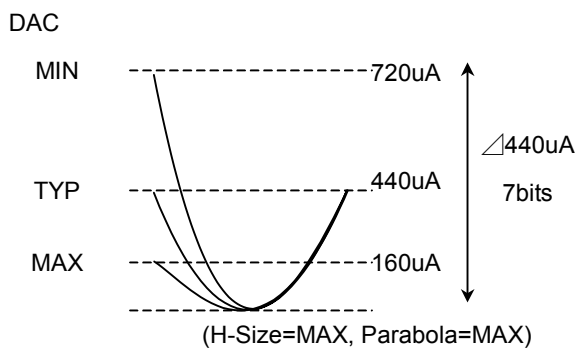

Coner (Top)

Vertical control

V-centering

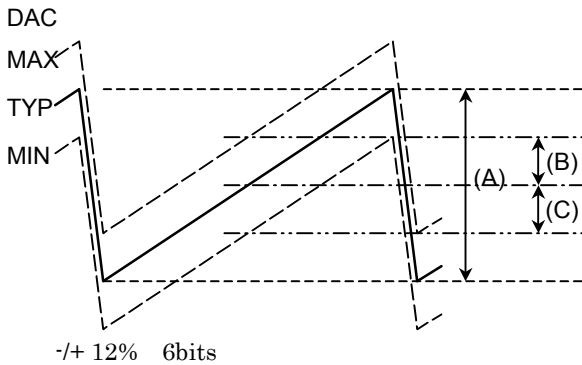

$$V-CENT(+) = B / A \times 100\%$$

$$V-CENT(-) = C / A \times 100\%$$

V-Size

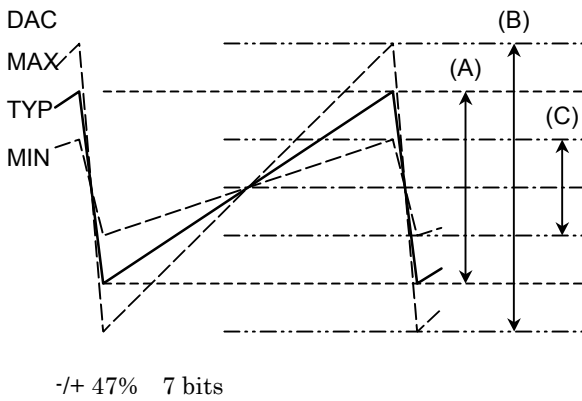

$$V-Size(max) = (B - A) / A \times 100\%$$

$$V-Size(min) = (C - A) / A \times 100\%$$

V-Linearity

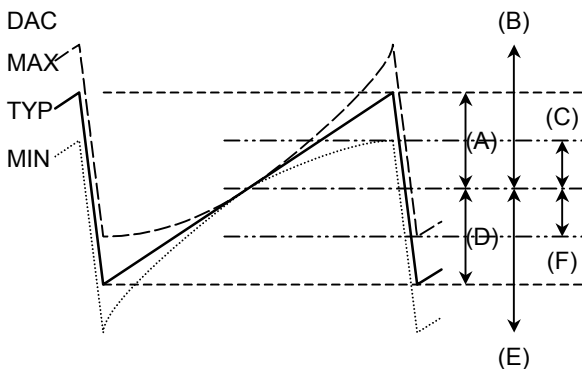

$$V-Lin = \{ (B - C) + (E - F) \} / \{ 2 \times (A + D) \} \times 100\%$$

V-S

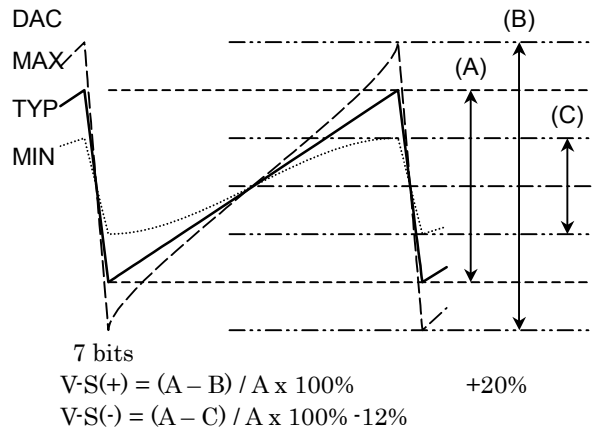

V-Phase

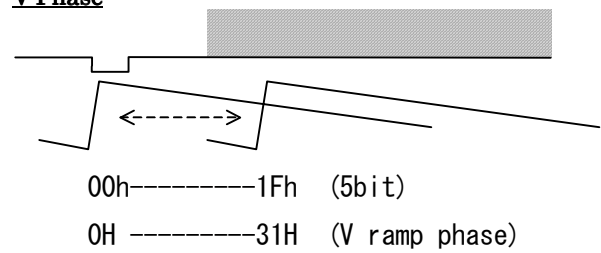

V-BLK (TOP)

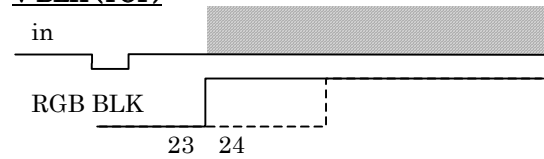

Blanking

	0	1	2	3	4	5	6	7
50Hz	23H 335H	25H 337H	27H 339H	29H 341H	31H 343H	33H 345H	35H 347H	37H 349H
60Hz	22H 284H	24H 286H	26H 288H	28H 290H	30H 292H	32H 294H	34H 296H	36H 298H

	8	9	A	B	C	D	E	F
50Hz	39H 351H	41H 353H	43H 355H	45H 357H	47H 359H	49H 361H	51H 363H	53H 365H
60Hz	38H 300H	40H 302H	42H 304H	44H 306H	46H 308H	48H 310H	50H 312H	52H 314H

V-BLK (Bottom)

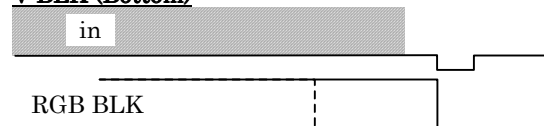

	0	1	2	3	4	5	6	7
50Hz	312H 625H	306 621	302 617	298 613	294 609	290 605	286 601	282 597
60Hz	263H 1H	259 522	255 518	251 514	247 510	243 506	239 502	235 498

10, Electrical Characteristics

(unless otherwise specified, Ta = 25°C, V_{CC} = 5.0 and 9.0 V for each appropriate)

DC CHARACTERISTIC CURRENT CONSUMPTION

Characteristics	Symbol	Test Circuit	Test Condition	Min	Typ.	Max	Unit
IF V _{cc} (5V)	I _{ccIF5}		Supply 5.0 V	24	30	38	mA
IF V _{cc} (9V)	I _{ccIF9}		Supply 9.0 V	10	13	16.5	mA
RGB V _{CC} (9V)	I _{ccRGB9}		Supply 9.0 V	10.5	14	17.5	mA
H V _{CC} (9V)	I _{ccHVcc}		Supply 9.0 V	13.5	18	22.5	mA
DIGITAL V _{DD} (around 3.3V)	I _{dd}		Supply 9.0 V via 270 ohms	16	20	24	mA
Y/C V _{CC} (5V)	I _{ccYC5}		Supply 5.0 V	58	78	98	mA

PIN VOLTAGE

Characteristics		Symbol	Test Circuit	Test Condition	Min	Typ.	Max	Unit
4	FM Filter	V4			2.5	4.5	6.5	V
6	X'TAL	V6			2.6	3.6	4.6	V
7	APC FILTER	V7			2.0	3.0	4.0	V
9	SECAM Filter	V9			1.6	2.6	3.6	V
18	VSM OUT	V18			2.2	3.2	4.2	V
20	YS/YM SW	V20				0.0	0.25	V
21	EXT. R IN	V21			2.0	3.3	4.5	V
22	EXT. G IN	V22			2.0	3.3	4.5	V
23	EXT. B IN	V23			2.0	3.3	4.5	V
31	ABCL IN	V31			4.0	6.0	7.0	V
34	CW OUT	V34			2.0	2.7	3.5	V
43	H AFC FILTER	V43			6.0	7.0	8.0	V
44	Y3/CVBS3 in	V44		at sync tip in non-selected at 35%of sync in selected		1.8 2.2		V
47	V OUT	V47		Average DC voltage	4.5	5.0	5.5	V
48	Cr3 in	V48			2.2	3.2	4.2	V
49	Cb3 in	V49			2.2	3.2	4.2	V
51	Cr OUT	V51			1.5	2.5	3.5	V
52	Cb OUT	V52			1.5	2.5	3.5	V
54	BLACK DET	V54			1.0	1.6	3.5	V
55	Y2/CVBS2/G in	V55		at sync tip in non-selected at 35%of sync in selected		1.8 2.2		V
56	Cb2/B in	V56			2.0	3.0	4.0	V

Characteristics		Symbol	Test Circuit	Test Condition	Min	Typ.	Max	Unit
57	Cr2/R in	V57			2.0	3.0	4.0	V
58	C1 in	V58			1.5	2.5	3.5	V
59	YS	V59				0	0.25	V
61	Y1/CVBS1 in	V61		at sync tip in non-selected at 35% of sync in selected		1.8 2.2		V
62	DC RESTORE	V62		on input 50IRE Y signal	1.5	2.5	3.5	V
65	De-Emp/Mon OUT	V65			1	4.1	8	V
69	LOOP FILTER	V69			1.2	2.2	3.2	V
71	SIF OUT	V71			1.0	2.0	3.0	V
73	SIF in / H corr.	V73				3.0		V
75	SIF in(1)	V75			1.0	2.0	3.0	V
76	SIF in(2)	V76			1.0	2.0	3.0	V
79	PIF in(1)	V79			1.0	2.0	3.0	V
80	PIF in(2)	V80			1.0	2.0	3.0	V

AC CHARACTERISTIC

PIF STAGE

ITEM		SYMBOL	TEST CIRCUIT	TEST COND ITON	MIN	TYP	MAX	UNIT
PIF STAGE								
Video output signal amplitude	Nega	V Det (p)n	in: #79,80 out: #68	P1	2.0	2.2	2.4	V
	Posi	V Det (p)p			2.0	2.2	2.4	
PIF input sensitivity		vin min(p)		P2	-	42	47	dB(uV)
PIF maximum input signal		vin max(p)			100	105	-	
PIF gain control range		RAGC(p)			53	63	-	dB
Synchronous signal level	Nega	Vsync n		P3	2.6	2.8	3.0	V
	Posi	Vsync p			2.6	2.8	3.0	
Differential gain		DG		P4	-	2	5	%
Differential phase		DP			-	2	5	
Video bandwidth (-3dB)		fDet(p)		P5	6	8	-	MHz
Video output S/N		S/N(p)		P6	54	60	-	dB
Inter Modulation		I M		P7	34	40	-	dB
PIF input resistance (*)		Zin R(p)	in: #79,80 out: #79,80	P8	-	3	-	kΩ
PIF input capacitance (*)		Zin C(p)	in: #79,80 out: #78		-	-	-	pF
RF AGC output voltage	max	VAGC max	in: #79,80 out: #78	P9	-	9.0	-	V
	min	VAGC min			-	-	0.3	
RF AGC delay point	min	v Dly min	in: #79,80 out: #68	P10	-	70	80	dB(uV)
	max	v Dly max			100	110	-	
Capture range of the PLL	Upper	fpH(p)	in: #79,80 out: #68	P11	1.4	1.7	-	MHz
	Lower	fpL(p)			-	-1.7	-1.4	
Hold range of the PLL	Upper	fhH(p)			1.4	1.7	-	
	Lower	fhL(p)			-	-1.7	-1.4	
Control steepness of the VCO		β	in: #79,80 out: #69	P12	-	3.0	-	MHz/V
AFT Center turn Frequency		fAFTC	in: #79,80 out: BUS (r)	P13		0		MHz
AFT window	narrow	fAFTW(n)L	in: #79,80 out: BUS (r)	P14		-50		kHz
		fAFTW(n)H				50		
	Wide	fAFTW(w)L				-200		
		fAFTW(w)H				200		
S-trap reduction			in: #79,80 out: #68	P15		-30	-24	

ITEM	SYMBOL	TEST CIRCUIT	TEST COND ITON	MIN	TYP	MAX	UNIT
1ST SIF STAGE							
SIF maximum input signal	vin max(s)1	in: #75,76	S1	100	110	-	dB(uV)
SIF minimum input signal	vin min(s)1	in(uc): #79,80		-	40	50	dB(uV)
SIF gain control range	RAGC(s)1	out: #71		50	70	-	dB
2nd SIF output level	vSIF1			100	103	106	dB(uV)
SIF input resistance(*)	Zin R(s)	in: #75,76	S2	-	10	-	kΩ
SIF input capacitance(*)	Zin C(s)	out: #75,76		-	5	-	pF
AM sound							
AM input sensitivity	vin minAM	in: #75,76	S3	-	40	50	dB(uV)
AM maximum input level	vin maxAM	in(uc): #79,80		100	110	-	
2nd SIF output level (L)	vSIF L			100	103	106	dB(uV)
AF output signal amplitude (AM)	vDet(s)AM	out: #65	S4	375	500	665	mVrms
AF output S/N (AM)	S/N(s)AM			48	54	-	dB
Total harmonics distortion (AM)	THDAM			-	0.7	3.0	%
2nd SIF stage							
AF output signal amplitude(5.5MHz)	vDet(s)5.5M	in: 73 out: 71	S5	695	927	1236	mVrms
AF output S/N (5.5MHz)	S/N(s)5.5M			55	60	-	dB
Total harmonics distortion (5.5MHz)	THD5.5M			-	0.3	1.0	%
AF output signal amplitude (6.0MHz)	vDet(s)6.0M		S6	695	927	1236	mVrms
AF output S/N (6.0MHz)	S/N(s)6.0M			55	60	-	dB
Total harmonics distortion (6.0MHz)	THD6.0M			-	0.3	1.0	%
AF output signal amplitude (6.5MHz)	vDet(s)6.5M		S7	695	927	1236	mVrms
AF output S/N (6.5MHz)	S/N(s)6.5M			55	60	-	dB
Total harmonics distortion (6.5MHz)	THD6.5M			-	0.3	1.0	%
AF output signal amplitude (4.5MHz Low)	vDet(s)4.5M L		S8	350	500	710	mVrms
AF output S/N (4.5MHz Low)	S/N(s)4.5ML			52	58	-	dB
Total harmonics distortion (4.5MHz Low)	THD4.5ML			-	0.3	1.0	%
AF output signal amplitude (4.5MHz High)	vDet(s)4.5M H		S9	649	927	1324	mVrms
AF output S/N (4.5MHz High)	S/N(s)4.5M H			52	58	-	dB
Total harmonics distortion (4.5MHz High)	THD4.5MH			-	0.3	1.0	%
Limiting sensitivity (4.5MHz Low) (4.5MHz High) (5.5MHz) (6.0MHz) (6.5MHz)	lim(s)4.5ML		S10	-	40	45	dB(uV)
	im(s)4.5MH			-	45	50	
	lim(s)5.5M			-	40	45	
	lim(s)6.0M			-	40	45	
AM reduction ratio (4.5MHz High) (4.5MHz Low) (5.5MHz) (6.0MHz) (6.5MHz)	AMR4.5MH		S11	50	55	-	dB
	AMR 4.5ML			50	55	-	dB
	AMR5.5M			50	60	-	dB
	AMR6.0M			50	60	-	dB
Demodulation band width of the FM demodulator (Upper 1)	fpH(s)1		S12	-	130	-	kHz
	Demodulation band width of the FM demodulator (Lower1)			fpL(s)1	-	-130	
VIDEO STAGE							
Y Input Dynamic Range	Y1 in	in: #61 out: #53	V1	0.9	1.0	-	V(p-p)
Y Delay time (PAL NTSC)	tyDELP		V2	350	440	530	ns
	(SECAM)		tyDELS	570	680	790	ns
	(000)		tyDEL120	-80	-120	-160	ns
	(111)		tyDEL160	120	160	200	
	1step		tyDEL_step	30	40	50	
Chroma Trap Gain	3.58MHz		GTRAP358	V3	-	-27	-23
	4.43MHz	GTRAP443	-	-	-27	-23	
Y gain (Y)	G Y1		V4	5.0	5.5	6.0	dB
Y frequency response	FRY		V5	5.5	8.0	-	MHz
Mon out gain (MON)	(Y1/CVBS1)	GTV1	V6	5.5	6	6.5	dB
	(Y2/CVBS2)	GTV2		5.5	6	6.5	dB
	(Y3/CVBS3)	GTV3		5.5	6	6.5	dB
Y frequency response	FRY	in:#61 / out:#53	V7	5.5	8.0	-	MHz

ITEM	SYMBOL	TEST CIRCUIT	TEST CONDITION	MIN	TYP	MAX	UNIT	
V switch cross-talk (CVBS1-CVBS2) (CVBS1-CVBS3) (CVBS2-CVBS1) (CVBS2-CVBS3) (CVBS3-CVBS1) (CVBS3-CVBS2)	CT _{V1,2}	in: #61, 55 or 44 out: #53	V8			-55	dB	
	CT _{CVBS1,3}					-55		
	CT _{CVBS2,1}					-55		
	CT _{CVBS2,3}					-55		
	CT _{CVBS3,1}					-55		
	CT _{CVBS3,2}					-55		
RGB input D-range				0.9	1.0	—	V (p-p)	
Ys Mode Switching Level				0.5	0.7	0.9		
CHROMA STAGE								
ACC Characteristic	V _{ACCL}		C1	—	25	40	mV(p-p)	
	V _{ACCH}			600	1000	—		
TOF Characteristic.(4.43)	f _o Q	F _{OT443} Q _{T443}	(*) test mode	C2	4.87 1.6	5.07 1.8	5.27 2.0	MHz
BPF Characteristic. (4.43)	f _o Q	F _{OB443} Q _{B443}			4.26 1.6	4.46 1.8	4.66 2.0	
TOF Characteristic. (3.58)	f _o Q	F _{OT358} Q _{T358}		C2	4.05 1.6	4.25 1.8	4.46 2.0	MHz
BPF Characteristic. (3.58)	f _o Q	F _{OB358} Q _{B358}			3.43 1.6	3.63 1.8	3.83 2.0	
C Delay Time (PAL) (NTSC) (SECAM)	t _{CDELN}		C3	595	700	805	ns	
	t _{CDELP}			510	600	690		
	t _{CDELS}			765	900	1035		
APC Pull- In Range (4.43MHz)	F _{4APCP+} F _{4APCP-}	in: #58 uc_in ; #61 out: #51, 52	C4	350	450	—	Hz	
APC Hold Range (4.43MHz)	F _{4APCH+} F _{4APCH-}			-1500 -2000	-600 -600	-450 -450		
APC Pull-In Range (3.58MHz)	F _{3APCP+} F _{3APCP-}		C4	350	450	—	Hz	
APC Hold Range (3.58MHz)	F _{3APCH+} F _{3APCH-}			-1500 -2000	-600 -600	-450 -450		
APC Control Sensitivity (4.43MHz)	β ₄₄₃	in:#58 (#61) out: #7	C5	0.6	1.1	1.6	Hz/mV	
APC Control Sensitivity (3.58MHz)	β ₃₅₈			0.4	0.9	1.4		
PAL ID Sensitivity (Normal Mode)	V _{PIDON}	in: #58 in ; #61 out: #51, 52	C6	0.8	1.6	3.2	mV(p-p)	
	V _{PIDOFF}			0.9	1.8	3.6		
PAL ID Sensitivity (Low Mode)	V _{PIDLON}		C6	1.2	2.5	5.0	mV(p-p)	
	V _{PIDLOFF}			1.6	3.2	6.4		
NTSC ID Sensitivity (Normal Mode)	V _{NIDON}		C6	0.8	1.6	3.2	mV(p-p)	
	V _{NIDOFF}			1.0	2.0	4.0		
NTSC ID Sensitivity (Low Mode)	V _{NIDLON}		C6	1.4	2.8	5.6	mV(p-p)	
	V _{NIDLOFF}			1.8	3.6	7.2		
black adjustment (internal)	V _{B INT MAX}		C7	27.5	35.5	43.5	mV	
	V _{R INT MAX}			18.0	24.0	30.0	mV	
	V _{B INT MIN}			-39.5	-31.5	-30.7	mV	
	V _{R INT MIN}			-28.5	-22.5	-16.5	mV	
Black adjustment sensitivity (internal)	ΔV _{B INT}		C7	3.5	4.5	5.5	mV	
	ΔV _{R INT}			2.1	3.1	4.1	mV	
black adjustment (external)	V _{B EXT MAX}		C7	345	425	505	mV	
	V _{R EXT MAX}			190	230	290	mV	
	V _{B EXT MIN}			-585	-505	-425	mV	
	V _{R EXT MIN}			-355	-295	-235	mV	
Black adjustment sensitivity (external)	ΔV _{B EXT}		C7	49	62	75	mV	
	ΔV _{R EXT}		C7	27	35	43	mV	
CWOUT Amplitude 4.43M 3.58M	V _{CW}		C8	0.40	0.55	0.70	V(p-p)	
				0.60	0.75	0.90		
CbCr out amplitude Cr PAL Cb PAL Cr NTSC Cb NTSC		color bar (75%)	C8	0.38	0.53	0.68	V(p-p)	
				0.38	0.55	0.68		
				0.38	0.55	0.68		
				0.38	0.57	0.68		
SECAM STAGE								
SECAM CbCr Output Amplitude	V _{B S}	in:#58 (Color bar 75%)	C9	0.37	0.52	0.67	V(p-p)	
	V _{R S}			0.39	0.54	0.69		
SECAM CbCr out Relative Amplitude	R/B-S		C10	0.90	1.05	1.20		

ITEM	SYMBOL	TEST CIRCUIT	TEST COND ITON	MIN	TYP	MAX	UNIT		
SECAM CbCr out S/N Ratio	SNB-S	uc_in ; #61 out; #51, 52	C11	-	-44.	-28	dB		
	SBR-S			-	-45.	-32			
SECAM Linearity	LinB		C12	83	100	117	%		
	LinR			83	90	117	%		
SECAM Rising-Fall Time	trfB		C13	-	0.70	1.5	us		
	trfR			-	0.90	1.5			
SECAM ID Sensitivity (Normal Mode)	H		C14	V _{SIDHON}	1.2	2.5	5.0	mV(p-p)	
	H+V			V _{SIDHOFF}	1.4	2.8	5.6	mV(p-p)	
				V _{SIDHVON}	0.4	0.8	1.6	mV(p-p)	
				V _{SIDHVOFF}	0.9	1.8	3.6	mV(p-p)	
SECAM ID Sensitivity (Low Mode)	H			V _{SIDLHON}	1.3	2.6	5.2	mV(p-p)	
	H+V			V _{SIDLHOFF}	1.6	3.2	6.4	mV(p-p)	
				V _{SIDLHVON}	0.4	0.8	1.6	mV(p-p)	
				V _{SIDLHVOFF}	1.0	2.0	4.0	mV(p-p)	
YUV (Y)									
Brightness Control Characteristics	V _{BRTMAX}	in; #61 out; #14(B)	Y1	2.95	3.40	3.80	V (dc)		
	V _{BRTCEN}			1.95	2.40	2.85			
	V _{BRTMIN}			0.95	1.40	1.85			
Brightness Control resolution	ΔV _{BRT}			13.2	15.3	17.3	mV/(step)		
Contrast Control for Y	G _{UCYMAX}		Y2	13.0	14.7	16.3	dB		
	G _{UCYCEN}			8.2	9.8	11.4			
	G _{UCYMIN}			-4.4	-2.8	-1.2			
Sharpness Control	G _{SHMAX}		Y3	6.0	9.0	12.0	dB		
	G _{SHCEN}			3.5	4.5	5.5			
	G _{SHMIN}			-16.0	-13.0	-10.0			
Sharpness Peaking Frequency	F _{SHF}		Y4	2.7	3.7	4.7	MHz		
Sharpness Coring	G _{COR}			-0.9	-0.7	-0.5	dB		
Y γ correction start point	V _{Yγ 70}		Y5	67	70	73	(IRE)		
	V _{Yγ 80}			74	77	80			
	V _{Yγ 90}			82	85	88			
Y γ correction curve	G _{Yγ}			-6	-5	-4	dB		
Black stretch AMP Gain	G _{BLEX}		Y6	1.15	1.3	1.55			
Black stretch Start Point	V _{BLEX 25IRE}			21	25	29	V		
	V _{BLEX 35IRE}			30	34	38			
	V _{BLEX 45IRE}			39	43	47			
DC restoration gain	V _{dcrest90}		Y7	85	90	95	(IRE)		
	V _{dcrest110}			103	108	113			
	V _{dcrest120}			110	115	120			
	V _{dcrest step}			5	8	11			
WPS Level	V _{WPS}		Y8	3.94	4.24	4.54	V(p)		
VSM Peak Frequency	F _{VSM}	in; #61	Y9	2.5	3.5	4.5	MHz		
VSM Gain (VM-G = 0dB) (VM-G = -3dB) (VM-G = -10dB) (VM-G = off)	G _{VSM 0}	out; #18	Y10	-0.7	0.50	1.70	dB		
	G _{VSM-3}			2.7	4	5.			
	G _{VSM-10}			8.	9.	10.5			
	G _{VSM OFF}			-	-22.5	-18.5			
VSM Phase 2T Pulse (0) 2T Pulse (1) BUS (1)-(0)	T _{VMET (0)}		Y11	-190	-150	-110	ns		
	T _{VMET (1)}			-120	-90	-60			
	T _{VMBUS}			45	60	75			
VSM Mute Threshold Level on Ys	V _{VMBLK}		V18	0.5	0.7	0.9	V		
YUV (UV)									
TINT control range	MAX	in; #58 uc_in ; #61	UV1	Δθ _{MAX}	28	35	43	deg	
	MIN			Δθ _{MIN}	-28	-35	-43		
Color Control	MAX	out; #12, 13, 14	UV2	G _{COLMAX}	4.7	6.2	7.7	dB	
	MIN			G _{COLMIN}	-	-	-25		
Contrast Control for UV	Min		UV3	G _{UCCMIN}	-15.0	-13.0	-11.0	±2dB	
	Center			G _{UCCEN}	-	0	-		
	Max			G _{UCCMAX}	3.0	5.00	7.0		±2dB
				G _{UCC}	14.5	18.00	21.5		
Relative Amplitude (PAL1)	R/B		UV4	V _{P1R/B}	0.45	0.55	0.65		
	G/B			V _{P1G/B}	0.27	0.33	0.39		

ITEM	SYMBOL	TEST CIRCUIT	TEST CONDITION	MIN	TYP	MAX	UNIT			
Relative Amplitude (PAL2)	R/B			0.68	0.78	0.88				
	G/B			$V_{P2G/B}$	0.27	0.33		0.39		
Relative Amplitude (NTSC1)	R/B			$V_{N1R/B}$	0.69	0.79		0.89		
	G/B			$V_{N1G/B}$	0.22	0.28		0.34		
Relative Amplitude (NTSC2)	R/B			$V_{N2R/B}$	0.68	0.78		0.88		
	G/B			$V_{N2G/B}$	0.27	0.33		0.39		
Relative Phase (PAL1)	R-B			θ_{P1R-B}	UV5	85		90	95	deg
	G-B			θ_{P1G-B}		235		240	245	
Relative Phase (PAL2)	R-B			θ_{P2R-B}		85		90	95	
	G-B			θ_{P2G-B}		235		240	245	
Relative Phase (NTSC1)	R-B			θ_{N1R-B}		100		105	110	
	G-B			θ_{N1G-B}		241		246	251	
Relative Phase (NTSC2)	R-B			θ_{N2R-B}		99		104	109	
	G-B			θ_{N2G-B}		232		237	242	
Half Tone reduction. for UV		G_{HTC}	UV6	-7		-6	-5	dB		
Half Tone reduction for Y		G_{HTY}	UV7	-7		-6	-5	dB		
RGB STAGE										
V-BLK Pulse Output Level		V_{VBLK}	in: #61 out: #12	T1		0.1	0.6	1.1	V(p)	
H-BLK Pulse Output Level		V_{HBLK}				0.1	0.6	1.1		
RGB Output Black Level (OIRE DC)		V_{BLACK}		T2		2.25	2.5	2.75	V	
RGB Output White Level(100IRE AC)		V_{WHITE}		T3	3.3	3.7	4.1	V(p)		
Cut-Off Voltage Variable Range		V_{CUT+}		T4	0.6	0.65	0.7	V		
		V_{CUT-}			-0.7	-0.65	-0.6	V		
Drive Control Variable Range		G_{DR+}		T5	3.0	4.0	5.0	dB		
		G_{DR-}			-7.5	-6.5	-5.5	dB		
ABCL Control Voltage Range		V_{ABCLH}		T6	5.6	5.9	6.2	V		
		V_{ABCLL}			4.2	4.5	4.8	V		
ACL Gain		G_{ACL}			-19.5	-17.5	-15.5	dB		
ABL Point		V_{ABLP1}		T7	-0.1	0	0.1	V		
		V_{ABLP2}			-0.26	-0.16	-0.06			
		V_{ABLP3}			-0.33	-0.23	-0.13			
		V_{ABLP4}			-0.36	-0.26	-0.16			
ABL Gain		V_{ABLG1}		T8	-0.32	-0.22	-0.12	V		
		V_{ABLG2}			-0.45	-0.35	-0.25			
		V_{ABLG3}			-0.62	-0.52	-0.42			
		V_{ABLG4}			-0.10	0	+0.10			
Analog RGB Gain			in: #20,21,22,23 out: #12, 13, 14		11.40	12.20	13.00	dB		
Analog RGB reduction on Ym						-6				
Analog RGB Dynamic Range		DR_{TX}			T9	0.7	1.0	-	V(p-p)	
Analog RGB Brightness Control Characteristic	MAX.	$V_{TXBRMAX}$			T11	2.9	3.3	3.7	V	
	CEN.	$V_{TXBRCEN}$				1.9	2.3	2.7	V	
	MIN.	$V_{TXBRMIN}$				0.9	1.3	1.7	V	
YsYm Mode Switching Level		V_{YSANA}			T12	0.52	0.72	0.92	V	
		V_{YSBLK}				1.82	2.02	2.22		
Analog RGB Mode Transfer Characteristic		τR_{YS}			T13	-	40	100	ns	
		tPR_{YS}				-	40	100		
		τF_{YS}		-		40	100			
		tPF_{YS}		-		40	100			
Cross Talk from Analog RGB toTV		CT_{TX-TV}		T14	-	-55	-40	dB		
Cross Talk from TV to Analog RGB		CT_{TV-TX}		T15	-	-46	-40	dB		
Analog RGB / RGB Output Voltage Axes Difference		ΔV_{R-G}		T17	-50	-	50	mV		
		ΔV_{G-B}			-50	-	50			
		ΔV_{B-R}			-50	-	50			
RGB Mute DC level		V_{RGBMR}		T18	1.7	1.9	2.1	V		
Blue Back level		V_{BB}			3.84	4.14	4.44	V		
DEF STAGE										
AFC Inactive Period	50Hz	$T_{50AFCOFF}$		D1	-	309-7	-	(H)		
	60Hz	$T_{60AFCOFF}$			-	262-10	-			
H-OUT Start Voltage		V_{HON}		D2	4.4	4.7	5.0	V		
H-OUT Pulse Duty		WH_{OUT}		D3	38.5	40.5	42.5	%		
H-OUT Freq. On AFC Stop Mode		$F_{HAFCOFF}$		D4	15.38	15.39	15.40	kHz		
Horizontal Free-Run Frequency	50Hz	F_{H50FR}		D5	15.475	15.625	15.775	kHz		

ITEM	SYMBOL	TEST CIRCUIT	TEST CONDITION	MIN	TYP	MAX	UNIT	
60Hz	F _{H60FR}			15.585	15.734	15.885	kHz	
Horizontal Freq. Variable Range	MAX. F _{HMAX}		D6	16.200	16.400	16.600	kHz	
	MIN. F _{HMIN}			14.600	14.900	15.200		
Horizontal Freq. Control Sensitivity	β _{HAFc}		D7	2.4	2.9	3.4	Hz/mV	
Horizontal Pull-In Range	F _{HPh}		D8	500	—	—	Hz	
	F _{HPL}			500	—	—		
H-OUT Voltage	V _{HOUTH}		D9	4.2	4.6	5.0	V	
	V _{HOUT}			—	0.15	0.30		
Horizontal Freq. Dependence on Vcc	Δ F _{HVCC}		D10	-20	0	20	Hz/V	
FBP Phase	PH _{FbP}		D11	2.7	3.2	3.7	us	
H-Sync. Phase	PH _{HsYnc}			0.2	0.3	0.4		
Horizontal Position Variable Range	Δ PH _{HPOS}		D12	6.3	6.8	7.3	us	
H correction control range	(+) Δ PH _{HcOR+}			1.0	1.2	1.4		us
	(-) Δ PH _{HcOR-}			-1.4	-1.2	-1.0		
AFC-2 Pulse Threshold Level	V _{AFC2}		D13	3.2	3.5	3.8	V	
H-BLK Pulse Threshold Level	V _{HBLK}		D14	0.8	1.3	1.6	V	
Wide H blank ratio	50Hz Left side Δ W _{WHBLK50L}			91	92	93		%
	50Hz Right side Δ W _{WHBLK50R}			88	89	90		
60Hz Left side Δ W _{WHBLK60L}		91		92	93			
60Hz Right side Δ W _{WHBLK60R}		91.5		92.5	93.5			
BLACK Peak Det. Stop Period (H)	PHBPDET		D15	8.5	9.0	9.5	us	
	WBPDET			14.5	15.0	15.5		
Gate Pulse Start Phase	PH _{GP}		D16	2.8	3.0	3.2	us	
Gate Pulse Width	W _{GP}			2.0	2.2	2.4		
Vertical Free-Run Frequency	Auto50 F _{VAUFR50}		D18	45	50	55	Hz	
	Auto60 F _{VAUFR60}			55	60	65		
	50Hz F _{V50FR}			45	50	55		
	60Hz F _{V60FR}			55	60	65		
Gate Pulse V-Masking Period	50Hz T _{50GPM}		D19	—	308.7	—	(H)	
	60Hz T _{60GPM}			—	261.10	—		
V.Ramp DC on Service Mode	V _{NOVRAMP}		D20	3.1	3.3	3.5	V	
Vertical Pull-In Range (Auto)	F _{VPAUL}		D21	—	224.5	—	(H)	
	F _{VPAUH}			—	344.5	—		
Vertical Pull-In Range (50Hz)	F _{VP50L}			—	274.5	—		
	F _{VP50H}			—	344.5	—		
Vertical Pull-In Range (60Hz)	F _{VP60L}			—	224.5	—		
	F _{VP60H}			—	294.5	—		
Vertical Period on Fixed Mode	T _{V312.5}		D22	—	312.5	—	(H)	
	T _{V262.5}			—	262.5	—		
	T _{V313}			—	313	—		
	T _{V263}			—	263	—		
VD Start Phase	50Hz PH _{50VD}		D23	27	29	31	us	
	60Hz PH _{60VD}			27	29	31		
VD Width	50Hz W _{50VD}			—	12	—	(H)	
	60Hz W _{60VD}			—	12	—		
V-BLK Start Phase	50Hz PH _{50VBLK}		D24	27	29	31	us	
	60Hz PH _{60VBLK}			27	29	31		
V-BLK Width	50Hz W _{50VBLK}			—	22	—	(H)	
	60Hz W _{60VBLK}			—	18	—		
Sand Castle Pulse Level	V _{SCPH}		D25	6.70	7.00	7.30	V	
	V _{SCPM}			4.60	4.90	5.20		
	V _{SCPL}			1.55	1.85	2.15		
HD pulse level	GP			4.5	5	5.5	V	
	HD			2.5	3	3.5		
VD pulse level	Low			—	0	0.1	V	
	High			2.5	3	3.5		
V-Ramp Amplitude	Low		D26	—	0	0.1	V	
	High			1.50	1.67	1.84		V(p-p)
Vertical out Amplitude	Cen V _{VOuT}			1.8	2.0	2.2	V(p-p)	
	Max R _{VOuT MAX}			+48	+52	+56		%
	Min R _{VOuT MIN}			-51	-47	-43		
Vertical center voltage	V _{OUTDC}			4.8	5	5.2	V	

ITEM		SYMBOL	TEST CIRCUIT	TEST COND ITON	MIN	TYP	MAX	UNIT
Vertical center	Max	V _{CENT MAX}			+10	+12	+14	%
	Min	V _{CENT MIN}			-14	-12	-10	
Vertical Linearity Variable Range		V _{LIN}		D27	±10.5	±12.5	±14.5	%
Vertical S Correction Variable Range	Max	V _{S(+)}		D28	+21	+23	+25	%
	Min	V _{S(-)}			-19	-17	-15	
Vertical Amplitude EHT Correction		ΔV _{EHT}		D29	8.0	9.0	10.0	%
E-W H size	Max	V _{EWDCMAX}		D30	550	700	850	uA
	Min	V _{EWDCMIN}			—	0	60	
E-W Parabola	Max	V _{EWPFMAX}		D35	360	480	600	uA (p-p)
	Min	V _{EWPFMIN}			—	0	10	
E-W Conner top	Max	V _{EWCTMAX}		D35	590	720	850	uA (p-p)
	Min	V _{EWCTMIN}			60	130	200	
E-W Conner bottom	Max	V _{EWCBMAX}		D36	590	720	850	uA (p-p)
	Min	V _{EWCBMIN}			60	130	200	
E-W Trapezium Correction	Max	V _{TRMAX}		D37	1	3	5	%
	Min	V _{TRMIN}			-9	-7	-5	
E-W DC EHT Correction		V _{EWDC EHT}		D38	110	170	230	uA
H-Bow Correction	Max	T _{HBOWMAX}		D39	+300	+400	+500	us
	Min	T _{HBOWMIN}			-650	-550	-450	us
H-Parallelogram Correction	Max	T _{HPARAMAX}			±100	±200	±300	us
	Min	T _{HPARAMIN}	±150		±250	±350	us	
NoiseDet level	BUS(0011)	V _{NDET3}	D40	10	25	40	mVpp	
	BUS (1111)	V _{NDET15}		265	280	295	mVpp	

TEST CONDITION PIF STAGE

Note	Items/Symbols	Bus conditions	Measurement methods
P1	Video output signal amplitude / vDet(p)n / vDet(p)p	RF AGC:except 0 PIF Freq. : 38.9MHz PIF det lev:01(b) L-SECAM MODE :0/1 Others : Preset	<ol style="list-style-type: none"> Input a signal that 38.9[MHz], 90[dB(μV)], and 87.5 [%] negative modulated by 100% white video signal at pin 79. Set the bit of "L-SECAM MODE" to "00". Measure the amplitude of the pin 68 output signal (vDet(p)n[V(p-p)]). Input a signal that 38.9[MHz], 90[dB(μV)], and 97 [%] positive modulated by 100% white video signal at pin 6. Set the bit of "L-SECAM MODE" to "01". Measure the amplitude of the pin 68 output signal (vDet(p)p[V(p-p)]).
P2	PIF Input Sensitivity / vin min(p) PIF maximum input signal / vin max(p) PIF gain control range / RAGC(p)	RF AGC:except 0 PIF Freq.:38.9MHz Others : Preset	<ol style="list-style-type: none"> Input a signal that 38.9[MHz], 90[dB(μV)], and 30 [%] modulated by 15 [kHz] sine wave at pin 79.. Measure the amplitude at Pin 68(vo#68 [V(p-p)]). Decreasing the IF input level, measure the input level at which the output amplitude at pin 68 turns to be -3dB against "vo#68" (vin min(p)[dB(μV)]). Increasing the IF input level, measure the input level at which the output amplitude at pin 54 turns to be -1dB against "vo#68" (vin min(p)[dB(μV)]). $RAGC(p)[dB] = vin\ max(p) - vin\ min(p)$
P3	Synchronous signal level / Vsync n / Vsync p	RF AGC:except 0 PIF Freq. : 38.9MHz L-SECAM MODE :0/1 Others : Preset	<ol style="list-style-type: none"> Input a signal that 38.9[MHz], 90[dB(μV)], 87.5[%] negative modulated by 100% white signal at pin 79. Set the bit of "L-SECAM MODE" to "00". Measure the voltage of the sync. tip at pin 68 (Vsync n[V]). Input a signal that 38.9[MHz], 90[dB(μV)], and 97 [%] positive modulated by 100% white video signal at pin 79. Set the bit of "L-SECAM MODE" to "01". Measure the voltage of the sync. tip at pin 68 (Vsync p[V]).
P4	Differential Gain / DG	RF AGC:except 0 PIF Freq.: 38.9MHz	<ol style="list-style-type: none"> Input a signal that 38.9[MHz], 90[dB(μV)], and 87.5 [%] modulated by 10 stair video signal at pin 79. Measure "DG[%]" and "DP[°]" for Pin54 output.
	Differential Phase / DP	Vi Pol:0/1 Others : Preset	
P5	Video bandwidth (-3dB) / fDet(p)	RF AGC:except 0 PIF Freq.: 38.9MHz L-SECAM MODE :0/1 Others : Preset	<ol style="list-style-type: none"> Input the mixture of 2 signals (signal1 : 38.9[MHz] / 82[dB(μV)], signal 2 : 38.8[MHz] / 69[dB(μV)]) to pin 79. Measure the minimum voltage of the output signal at pin 68 (Vo#68). Apply the DC voltage to pin 1 and adjust it so that the minimum voltage of the output signal at pin 68 is equal to Vo#68. Decrease frequency of the input signal 2 at pin 79, and measure amplitude of the output signal at pin 68. Measure fDet(p) shown as below.

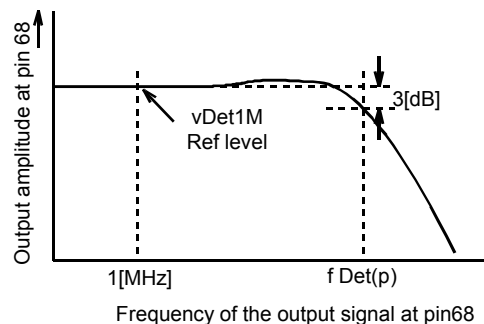

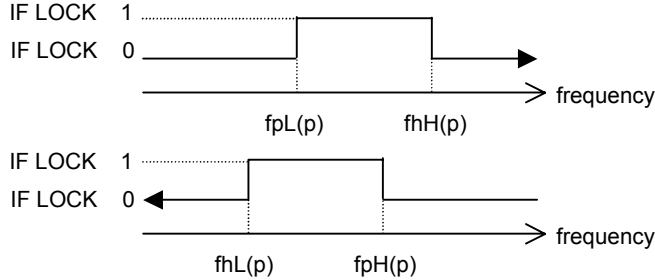
Note	Items/Symbols	Bus conditions	Measurement methods
P6	Video output S/N / S/N(p)	RF AGC:except 0 PIF Freq. : 38.9MHz Others : Preset	(1) Input a signal that 38.9[MHz], 90[dB(μV)], and 87.5 [%] modulated by black video signal at pin 6. (2) Measure the video S/N for pin 68 output (HPF : 100[kHz], LPF : 5[MHz], CCIR weighted) (S/N(p)[dB]).
P7	Intermodulation / IM	RF AGC:except 0 PIF Freq. : 38.9MHz Others : Preset	(1) Input a signal composed of following 3 signals at pin 79; 38.90[MHz]/90[dB(μV)], 34.47[MHz]/80dB(μV) 33.40[MHz]/80[dB(μV)] (2) Adjust pin 1 voltage so that the bottom of pin 68 output is equal to sync. tip level. (3) Measure the 1.07[MHz] level against the 4.43[MHz] level(=0[dB]) (IM[dB]).
P8	PIF input resistance / Zin R(p) PIF input capacitance / Zin C(p)	Preset	(1) Remove all connection from pin 79 and pin 80. (2) Measure the resistance (Zin R(p)[kΩ]) and capacitance (Zin C(p)[pF]) of pin 79 and pin 80 by the impedance meter.
P9	RF AGC output voltage / VAGC max / VAGC min	RF AGC:Adjust PIF Freq. : 38.9MHz Others : Preset	(1) Input a 38.9[MHz], 90[dB(μV)] signal at pin 79. (2) Adjust RF AGC so that the pin 78 voltage is 4.5V. (3) Increase the IF input level to 107dB(uV). (4) Measure the pin 78 voltage (VAGC min[V]). (5) Connect pin 79 and pin 80 to GND. (6) Measure the pin 78 voltage (VAGC max[V]).
P10	RF delay point / v Dly min / v Dly max	RF AGC : Adjust PIF Freq. 38.9MHz RF AGC: 01/3F Others : Preset	(1) Input a 38.9[MHz], 90[dB(μV)] signal at pin 79. (2) Set the data of "RF AGC" to 01(h). (3) Decrease the IF input level, measure the input level at which the voltage at pin 78 turn to be 4.5[V] (v Dly min[dB(μV)]). (4) Set the data of "RF AGC" to 3F(h). (5) Increase the IF input level, measure the input level at which the voltage at pin 78 turn to be 4.5[V] (v Dly max[dB(μV)]).
P11	Capture range of the PLL / fpH(p) / fpL(p) Hold range of the PLL / fhH(p) / fhL(p)	RF AGC : except 0 PIF Freq. : 38.9MHz Others : Preset	(1) Set the bit of "PIF Freq." to "(0,1,1), 38.9MHz". (2) Input a signal that f0=38.9[MHz], 60[dB(□V)] at pin 79. (3) As read the bit of "IF lock", sweep up/down the input signal frequency. (4) Measure fsuL, fsuH, fsdH, fsdL shown as below. fpH(p) = fsdH - f0 fpL(p) = fsuL - f0 fhH(p) = fsuH - f0 fhL(p) = fsdL - f0 [Read BUS DATA] The bit of "IF lock" 
P12	Control steepness of the VCO / β	PIF Freq. : 38.9MHz Others : Preset	(1) Set the bit of "VCO Adj. Req." to "1", and set the bit of "VCO Adj. Req." to "0". (2) Set the FET probe which connected to the spectrum analyzer near by pin 50 or pin 51 (Don't touch the probe directly to pin 50 or to pin 51). (3) Apply 2.3[V] to pin 47, and measure frequency of the VCO oscillation by the spectrum analyzer (fLVCO[MHz]). (4) Apply 2.7[V] to pin 47, and measure frequency of the VCO oscillation by the spectrum analyzer (fHVCO[MHz]). (5) β[MHz/V] = (fHVCO-fLVCO)/0.4

Note	Items/Symbols	Bus conditions	Measurement methods
P13	AFT Center turn Frequency / fAFTC	PIF Freq. : 38.9MHz Others : Preset	<p>(1) Input a signal that $f_0=38.9[\text{MHz}]$, $60[\text{dB}(\square\text{V})]$ at pin 79.</p> <p>(2) As read the bit of "AFT center", sweep up the input signal frequency.</p> <p>(3) Measure the lowest frequency that the bit of "AFT center" is "0", shown as below. That is fAFTC</p> <p>[Read BUS DATA] The bit of "AFT center"</p> <p style="text-align: center;">fAFTcxxx f0</p>
P14	AFT window narrow / fAFTW(n)L / fAFTW(n)H / fAFTW(w)L / fAFTW(w)H	PIF Freq. : 38.9MHz Others : Preset	<p>(1) Input a signal that $f_0=38.9[\text{MHz}]$, $60[\text{dB}(\square\text{V})]$ at pin 41.</p> <p>(2) Set the bit of "AFT window" to "(0), narrow".</p> <p>(3) As read the bit of "AFT window", sweep up the input signal frequency.</p> <p>(4) Measure the highest frequency but lower than f_0 (38.9MHz) that the bit of "AFT window" is "0", shown as below. That is fAFTw(n)L.</p> <p>(5) Measure the lowest frequency but higher than f_0 (38.9MHz) that the bit of "AFT window" is "0", shown as below. That is fAFTw(n)H.</p> <p>(6) Set the bit of "AFT window" to "(1), wide".</p> <p>(7) Measure as (3) ~ (5), that is fAFTw(w)L, fAFTw(w)H.</p> <p>[Read BUS DATA] The bit of "AFT window"</p> <p style="text-align: center;">fAFTwL f0 fAFTwH</p>
P15	S-trap reduction		<p>(1) Input a signal composed of following 3 signals at pin 79; $38.90[\text{MHz}]/90[\text{dB}(\mu\text{V})]$, $33.40[\text{MHz}]/80[\text{dB}(\mu\text{V})]$</p> <p>(2) Set the "Strap" of IICBUS to "0(h) off"</p> <p>(3) measure the output level of 5.5MHz component for pin #68 by spectrum analyzer. -> V68 (strap off)</p> <p>(4) Set the "Strap" of IICBUS to "4(h)"</p> <p>(5) measure the output level of 5.5MHz component for pin #68 by spectrum analyzer -> V68 (strap on)</p> <p>(6) Calc the result of reduction Strap = V68 (strap off) - V68 (strap on)</p>

SIF STAGE

Note	Items/Symbols	Bus conditions	Measurement methods
S1	SIF maximum input signal / vin max(s)1	RF AGC : except 0 PIF Freq. : 38.9MHz Others : Preset	(1) Input a 38.9[MHz], 90[dB(μV)] signal at pin 79.
	SIF minimum input signal / vin min(s)1		(2) Input a 33.4[MHz], 90[dB(μV)] signal at pin 75.
	SIF gain control range / R AGC(s)1		(3) Measure the amplitude at pin 71 (vSIF1[dB(μV)]).
	2nd SIF output level / vSIF1		(4) Decreasing the 33.4[MHz] signal level, measure the 33.4[MHz] signal level at which the amplitude at pin 3 turns to be -3[dB] against "vSIF1" (vin min(s)1[dB(μV)]).
S2	SIF input resistance / Zin R(s)	Preset	(5) Increasing the 33.4[MHz] signal level, measure the 33.4[MHz] signal level at which the amplitude at pin 3 turns to be +3[dB] against "vSIF1" (vin max(s)1[dB(μV)]).
	SIF input capacitance / Zin C(s)		(6) R AGC[dB] = vin max1(s) - vin min1(s)
S3	AM demodulation sensitivity / vin minAM AM demodulation maximum input level / vin maxAM	RF AGC: except0 PIF Freq. : 38.9MHz SIF Freq. : 6.5MHz L-SECAM MODE : 1 Others : Preset	(1) Input a 38.9[MHz], 90[dB(μV)] signal at pin 79. (2) Input a signal that 32.4[MHz], 80[dB(μV)] and 54[%] modulated by 400[Hz] sine wave at pin 75. (3) Measure the amplitude at pin 71 (v#71[mVrms]). (4) Decrease the 32.4[MHz] signal level, measure the 32.4[MHz] signal level at which the amplitude at pin 71 turns to be -3[dB] against "v#71" (vin minAM[dB(μV)]). (5) Increase the 32.4[MHz] signal level, measure the 32.4[MHz] signal level at which the amplitude at pin 71 turns to be -3[dB] against "v#71" (vin maxAM[dB(μV)]).
S4	AF output signal amplitude / vDet(s)AM AF output S/N / S/N(s)AM Total harmonics distortion / THDAM	SIF-Freq. : 6.5M L SECAM mode : L SECAM Others : Preset	(1) Input a 38.9[MHz], 90[dB(μV)] signal at pin 79. (2) Input a signal that 32.4[MHz], 80[dB(μV)] and 54[%] modulated by 400[Hz] sine wave at pin 75 (3) Measure the amplitude at pin 65 (vDet(s)AM[mVrms]). (4) Measure the total harmonics distortion at pin 65 (THDAM[%]). (5) Input a signal that 32.4[MHz], 80[dB(μV)] at pin 75 (6) Measure the amplitude at pin 65 (vn(s)[mVrms]). (7) S/N AM[dB] = 20log(vDet(s)/vn(s))
S5	AF output signal amplitude / vDet(s)5.5M AF output S/N / S/N(s)5.5M Total harmonics distortion / THD5.5M	SIF-Freq. :5.5M Others : Preset	(1) Input a signal that 5.5[MHz], 100[dB(μV)], 50[kHz] deviated by 400[Hz] sine wave at pin 73. (8) Measure the amplitude at pin 65 (vDet(s)5.5MH[mVrms]). (9) Measure the total harmonics distortion at pin 65 (THD5.5MH[%]). (2) Input a 5.5[MHz], 100[dB(μV)] signal at pin 73. (3) Measure the amplitude at pin 65 (vn(s)[mVrms]). (4) (6)S/N4.5MH[dB] = 20log(vDet(s)/vn(s))
S6	AF output signal amplitude / vDet(s)6.0M AF output S/N / S/N(s)6.0M Total harmonics distortion / THD6.0M	SIF-Freq. : 6.0M AUDIO ATT : 127 Others : Preset	(1) Input a signal that 6.0[MHz], 100[dB(μV)], 50[kHz] deviated by 400[Hz] sine wave at pin 73. (2) Do same measuring as vDet(s)5.5M et al. (vDet(s)6.0M, S/N(s)6.5M, THD6.0M).

Note	Items/Symbols	Bus conditions	Measurement methods
S7	AF output signal amplitude / vDet(s)6.5M AF output S/N / S/N(s)6.5M Total harmonics distortion / THD6.5M	SIF-Freq. : 6.5M AUDIO ATT : 127 Others : Preset	(1) Input a signal that 6.5[MHz], 100[dB(μV)], 50[kHz] deviated by 400[Hz] sine wave at pin 73. (2) Do same measuring as vDet(s)5.5M et al. (vDet(s)6.5M, S/N(s)6.5M, THD6.5M).
S8	AF output signal amplitude / vDet(s)4.5ML AF output S/N / S/N(s)4.5ML Total harmonics distortion / THD4.5ML	SIF-Freq. : 4.5M Au Gain : 1 AUDIO ATT : 127 Others : Preset	(1) Input a signal that 4.5[MHz], 100[dB(μV)], 25[kHz] deviated by 400[kHz] sine wave at pin 73. (2) Do same measuring as vDet(s)5.5MH et al. (vDet(s)4.5ML, S/N(s)4.5ML, THD4.5ML).
S9	AF output signal amplitude / vDet(s)4.5MH AF output S/N / S/N(s)4.5MH Total harmonics distortion / THD4.5MH	SIF-Freq. : 4.5M Au Gain : 0 AUDIO ATT : 127 Others : Preset	(1) Input a signal that 4.5[MHz], 100[dB(μV)], 25[kHz] deviated by 400[Hz] sine wave at pin 73. (2) Do same measuring as vDet(s)5.5M et al. (vDet(s)4.5MGH, S/N(s)4.5ML, THD4.5MH).
S10	Limiting sensitivity / vin lim(s)4.5MH / vin lim(s)4.5ML / vin lim(s)5.5M / vin lim(s)6.0M / vin lim(s)6.5M	SIF-Freq. : 4.5M/5.5M/6.0M/6.5M AUDIO ATT : 127 Au Gain : 0/1 Others : Preset	(1) Set the bits of "SIF-Freq." to "11", "Au Gain" to "0". (2) Input a signal that 4.5[MHz], 100[dB(μV)], 25[kHz] deviated by 400[Hz] sine wave at pin 73. (3) Measure the amplitude at pin 65 (vo#65[mVrms]). (4) Decreasing the 4.5[MHz] signal level, measure the 4.5[MHz] signal level at which the amplitude at pin 65 turns to be -3[dB] against "vo#4" (vin lim(s)4.5MH[dB(μV)]). (5) Input a signal that 4.5[MHz], 100[dB(μV)], 25[kHz] deviated by 400[Hz] sine wave at pin 73. (6) Set the bits of "Au Gain" to "1". (7) Do same measuring as above (3)~(4) (vin lim(s)4.5ML). (8) Set the bits of "SIF-Freq." to "00". (9) Change the frequency of the input signal to 5.5MHz, and change the deviation of the input signal to 50[kHz]. (10) Do same measuring as above (3)~(4) (vin lim(s)5.5M). (11) Set the bits of "SIF-Freq." to "01". (12) Change the frequency of the input signal to 6.0MHz, and do same measuring as above (3)~(4) (vin lim(s)6.0M). (13) Set the bits of "SIF-Freq." to "10". (14) Change the frequency of the input signal to 6.5MHz, and do same measuring as above (3)~(4) (vin lim(s)6.5M).

Note	Items/Symbols	Bus conditions	Measurement methods
S11	AM reduction ratio / AMR4.5MH / AMR4.5ML / AMR5.5M / AMR6.0M / AMR6.5M	SIF-Freq. : 4.5M/5.5M/6.0M/ 6.5M AUDIO ATT : 127 Au Gain : 0/1 Others : Preset	<ol style="list-style-type: none"> (1) Set the bits of "SIF-Freq." to "11", "Au Gain" to "0". (2) Input a signal that 4.5[MHz], 100[dB(μV)], 25[kHz] deviated by 400[Hz] sine wave at pin 73. (3) Measure the amplitude at pin 65 (vo#65[mVrms]). (4) Input a signal that 4.5[MHz], 100[dB(μV)], and 30 [%] modulated by 400 [Hz] sine wave at pin 73. (5) Measure the amplitude at pin 65 (v#65[mVrms]). (6) $AMR4.5H[dB] = 20\log(v\#65/ vo\#65)$ (7) Input a signal that 4.5[MHz], 100[dB(μV)], 25[kHz] deviated by 400[Hz] sine wave at pin 73. (8) Set the bits of "Au Gain" to "1". (9) Do same measuring as above (3)~(6) (AMR4.5ML). (10) Set the bits of "SIF-Freq." to "00". (11) Change the frequency of the input signals to 5.5MHz, and change the deviation of the input signal to 50[kHz]. (12) Do same measuring as above (3)~(6) (AMR5.5M). (13) Set the bits of "SIF-Freq." to "01". (14) Change the frequency of the input signals to 6.0MHz, and do same measuring as above (3)~(6) (AMR6.0M). (15) Set the bits of "SIF-Freq." to "10". (16) Change the frequency of the input signals to 6.5MHz, and do same measuring as above (3)~(6) (AMR6.5M).
S12	Demodulation band width of the FM demodulator / fpH(s)1 / fpL(s)1	SIF-Freq. : 4.5M AUDIO ATT : 127 Others : Preset	<ol style="list-style-type: none"> (1) Input a signal that 4.5[MHz], 100[dB(□V)], 25[kHz] deviated by 400[Hz] sine wave at pin 73. (2) Measure the amplitude at pin 65(vo#65 [V(p-p)]). (3) Increase the input signal frequency, measure the input signal frequency at which the output amplitude at pin 65 turn to be -3[dB] against "vo#65" (fpH(s)1[MHz]) (4) Decrease the input signal frequency, measure the input signal frequency at which the output amplitude at pin 65 turn to be -3[dB] against "vo#65" (fpL(s)1[MHz])

VIDEO stage (RGB Mute:0 / R cut off:128 / DC rest.:2(100%) / WPS:1(OFF))

Note	Items/Symbols	Bus conditions	Measurement methods
V1	Y Input Dynamic Range / DR _Y	Y/Monout=0 ctrp = off Ydl=011(b) Others: Preset	(1) Input a white signal with sync into Pin61. (2) Increasing the Pin61 input amplitude, measure the amplitude at which the Pin53 output is clipped, that is "DR _Y ".
V2	Y Delay Time / t _{YDEL} P / t _{YDELS} / Δ t _{YDEL-120} / Δ t _{YDEL+160} / Δ t _{YDEL} step	Y/Monout=0 ctrp = off Ydl=parametric Others: Preset	(1) Input a 2T pulse with sync and PAL burst into Pin61. (2) Set the BUS data so that Y DL is 0ns(011).Observe the Pin53 output, measure the delay time between Pin61 and Pin53, that is "t _{YDEL} P". (3) Set the BUS data so that Y DL is -120ns(000). Observe the Pin53 output, measure the delay time between Pin61 and Pin53 that is t _{YDEL-120} . (4) Set the BUS data so that Y DL is +160ns(111). Observe the Pin53 output, measure the delay time between Pin61 and Pin53 that is t _{YDEL+160} . (5) Calculate, "Δ t _{YDEL-120} "= t _{YDEL-120} - "t _{YDEL} " 1. "Δ t _{YDEL+160} "= t _{YDEL+160} - "t _{YDEL} " 2. "Δ t _{YDEL} "= ("Δ t _{YDEL+160} " - "Δ t _{YDEL-120} ")/7 (6) Input a 2T pulse with sync and SECAM ID into Pin61. (7) Set the BUS data so that Y DL is 0ns(011).Observe the Pin53 output, measure the delay time between Pin61 and Pin53, that is "t _{YDELS} ".
V3	Chroma Trap Gain / G _{TRAP}	Y/Monout=0 ctrp=parametric Ydl=011(b) Others: Preset	(1) Input a 0.5V(p-p), 4.43MHz signal with sync into Pin61. (2) Measure the 4.43MHz amplitude at Pin53 for Chroma Trap:1/0, that is V _{TRAPON} / V _{TRAPOFF} . (3) Calculate:"G _{TRAP443} "=20*log(V _{TRAPON} /V _{TRAPOFF}) (4) Input a 0.5V(p-p), 3.58MHz signal with sync into Pin61. (5) Measure the 3.58MHz amplitude at Pin53 for Chroma Trap:1/0, that is V _{TRAPON} / V _{TRAPOFF} . (6) Calculate:"G _{TRAP358} "=20*log(V _{TRAPON} /V _{TRAPOFF})
V4	Y gain		(1) Input 1Vp-p white signal with sync into pin #61 (2) Measure the gain between pin#61 and pin #53 for its picture (without sync) level. Gy1
V5	Y Frequency Response / FR _Y	Y/Monout=0 ctrp = off Ydl=011(b) Others: Preset	(1) Input a 0.5V(p-p) sweep signal with sync into Pin61. (2) Measure the frequency at which the output amplitude is 3dB down against the level of 100Hz, which is "FR _Y ".
V6	Mon out gain (MON) (Y1/CVBS1) G _{TV1} (Y2/CVBS2) G _{TV2} (Y3/CVBS3) G _{TV3}	Y/Monout=1 videosw=parametric Others: Preset	(1) Input 1Vp-p white signal with sync into pin #61, #55, and #44 (2) Measure the gain from pin#61, #55 and #44 to pin #53 in switching the ICBUS of 'video sw'.
V7	Y frequency response FR _Y	Y/Mon out = 1 video sw = 00 Others: Preset	(1) Input a 0.5V(p-p) sweep signal with sync into Pin61. (2) Measure the frequency at which the output amplitude is 3dB down against the level of 100Hz, which is "FR _Y ".
	V switch cross-talk (CVBS1-CVBS2) CT _{CVBS1_2} (CVBS1-CVBS3) CT _{CVBS1_3} (CVBS2-CVBS1) CT _{CVBS2_1} (CVBS2-CVBS3) CT _{CVBS2_3} (CVBS3-CVBS1) CT _{CVBS3_1} (CVBS3-CVBS2) CT _{CVBS3_2}	Y/Monout=1 videosw=parametric Others: Preset	(1) Input a sine wave signal (CVBS, V0=0.5Vp-p, f0=4MHz) into pin 61, connect pin 55 and 44 to GND through 0.1μF capacitor. (2) Set the bit of "Video SW" to "01, V2", and measure the amplitude of 4MHz signal at pin 53, that is V1-2. (3) Set the bit of "Video SW" to "00, V1" and measure the amplitude of 4MHz signal at pin 53, that is V1. (4) "C CVBS1_2" = 20*log (V1-2 / V1) (5) Measure the same way as (1)-(4) for others with the combination of desired and undesired inputs,

CHROMA STAGE (RGB Mute:0 / RGB cut off:128 / DC rest.:2(100%))

Note	Items/Symbols	Bus conditions	Measurement methods
C1	ACC Characteristics (4.43MHz) / V_{ACCH} / V_{ACCL}	RGB Mute:0 Y Mute:1 Uni-Color:127 Others: Preset	(1) Input a 4.43MHz PAL rainbow color-bar(300mV(p-p), burst:chroma=1:1) with sync into Pin61. (2) Changing the amplitude of burst and chroma, measure the input amplitude at which Pin51 output amplitude is +1dB/-1dB against the one for 300mVp-p input, that is " V_{ACCH} "/" V_{ACCL} ".
C2	TOF Characteristics (4.43MHz) / F_{0T443} / Q_{T443} BPF Characteristics (4.43MHz) / F_{0B443} / Q_{B443} TOF Characteristics (3.58MHz) / F_{0T358} / Q_{T358} BPF Characteristics (3.58MHz) / F_{0B358} / Q_{B358}	Measure on test mode s:21,d:00010000 s:1A,d:xx00xxxx BPF/TOF :0/1 Color System: 2/4 F-ID =1 C-in sw= 1 (c in) Others: Preset	(1) Set "BPF/TOF" to 1, "Color System" to 4(443PAL). (2) Input a sweep signal into Pin #61 and #58. (3) Observe the frequency response at Pin34 and measure the Peaking Frequency / Q of chroma filter, that is " F_{0T443} " / " Q_{T443} ". (4) Set BPF/TOF to 0 and Color System to 4(443PAL) and repeat (2)&(3), that is " F_{0B443} " / " Q_{B443} ". (5) Set BPF/TOF to 1 and Color System to 2(358NTSC) and repeat (2)&(3), that is " F_{0T358} " / " Q_{T358} ". (6) Set BPF/TOF to 0 and Color System to 2(358NTSC) and repeat (2)&(3), that is " F_{0B358} " / " Q_{B358} ".
C3	C Delay Time / t_{CDEL} Delay Time Difference between Y/C / $\Delta t_{Y/C}$	Others: Preset	(1) Input a 4.43MHz PAL rainbow color-bar(300mV(p-p), burst:chroma=1:1) with sync into Pin61. (2) Observe the Pin51 output, measure the delay time between Pin61 and Pin51 that is " t_{CDEL} ". (3) Calculate;" $\Delta t_{Y/C}$ "= t_{YDEL} - t_{CDEL}
C4	APC Pull-in Range (4.43MHz) / ΔF_{4APCP+} / ΔF_{4APCP-} APC Hold Range (4.43MHz) / ΔF_{4APCH+} / ΔF_{4APCH-} APC Pull-in Range (3.58MHz) / ΔF_{3APCP+} / ΔF_{3APCP-} APC Hold Range (3.58MHz) / ΔF_{3APCH+} / ΔF_{3APCH-}	Color System: 4/2 Others: Preset	(1) Input a 4.43MHz PAL rainbow color-bar(300mV(p-p), burst:chroma=1:1) with sync into Pin61. (2) Set Color System to 4(443PAL). (3) For higher frequency than 4.43MHz, measure the burst frequency at which PLL pulls-in / locks out that is F_{4APCP+} / F_{4APCH+} . (4) For lower frequency than 4.43MHz, repeat (2), that is F_{4APCP-} / F_{4APCH-} . (5) Calculate: " ΔF_{4APCP+} "= F_{4APCP+} - 4433619 " ΔF_{4APCP-} "= F_{4APCP-} - 4433619 " ΔF_{4APCH+} "= F_{4APCH+} -4433619 " ΔF_{4APCH-} "= F_{4APCH-} - 4433619 (6) Input a 3.58MHz NTSC rainbow color-bar (286mV(p-p), burst:chroma=1:1) with sync into Pin61 and 58. (7) Set Color System to 2(358NTSC). (8) For higher frequency than 3.58MHz, repeat (2), that is F_{3APCP+} / F_{3APCH+} . (9) For lower frequency than 3.58MHz, repeat (2), that is F_{3APCP-} / F_{3APCH-} . (10) Calculate: " ΔF_{3APCP+} "= F_{3APCP+} -3579545 " ΔF_{3APCP-} "= F_{3APCP-} -3579545 " ΔF_{3APCH+} "= F_{3APCH+} -3579545 " ΔF_{3APCH-} "= F_{3APCH-} -3579545

Note	Items/Symbols	Bus conditions	Measurement methods
C5	APC Control Sensitivity (4.43MHz) / β_{443} APC Control Sensitivity (3.58MHz) / β_{358}	Color System: 4/2 Others: Preset	(1) Connect Pin61 to GND via a 1uF capacitor. (2) Set Color System to 4(443PAL). (3) Adjust Pin7 voltage so that the Pin34 output frequency is 4.433619MHz that is $V_{4APCCEN}$. (4) Measure the Pin34 output frequency when Pin7 voltage is $V_{4APCCEN}+200mV / V_{4APCCENT}$, that is F_{4APC+} / F_{4APC-} . (5) Calculate: " β_{443} "= $(F_{4APC+}-F_{4APC-})/200$ (6) Set Color System to 2 (358NTSC). (7) Adjust Pin7 voltage so that the Pin34 output frequency is 3.579545MHz that is $V_{3APCCEN}$. (8) Measure the Pin34 output frequency when Pin7 voltage is $V_{3APCCEN}+200mV / V_{3APCCEN}$, that is F_{3APC+} / F_{3APC-} . (9) Calculate: " β_{358} "= $(F_{3APC+}-F_{3APC-})/200$
C6	PAL ID Sensitivity (Normal Mode) / $V_{PALIDON}$ / $V_{PALIDOFF}$ PAL ID Sensitivity (Low Mode) / $V_{PALIDLON}$ / $V_{PALIDLOFF}$ NTSC ID Sensitivity (Normal Mode) / V_{NTIDON} / $V_{NTIDOFF}$ NTSC ID Sensitivity (Low Mode) / $V_{NTIDLON}$ / $V_{NTIDLOFF}$	P/N ID Sens:0/1 Color System: 4/2 Y Mute:01 Uni-Color:127 RGB Mute:0 BPF/TOF:0 BPF Others: Preset	(1) Set P/N ID Sens. to 0. (2) Set Color System to 4(443PAL). (3) Input a 4.43MHz PAL rainbow color-bar(300mV(p-p), burst:chroma=1:1) with sync into pin#61 and 58. (4) Measure the burst amplitude at which Pin13 DC level changes from high to low / from low to high, that is " $V_{PALIDON}$ " / " $V_{PALIDOFF}$ ". (5) Set Color System to 2(358NTSC). (6) Input a 3.58MHz NTSC rainbow color-bar (286mV(p-p), burst:chroma=1:1) with sync into pin#61 and 58, and repeat (3), that is " V_{NTIDON} " / " $V_{NTIDOFF}$ ". (7) Set P/N ID Sens.to 1, repeat (2) ~ (6) that are "VPALIDLON", "VPALIDLOFF", VNTIDLON and VNTIDLOFF.
C7	Black adjustment (internal) / $V_{BINTMAX}$ / $V_{RINTMAX}$ / $V_{RINTMIN}$ / $V_{RINTMIN}$ Black adjustment sensitivity (Internal) / ΔV_{BINT} / ΔV_{RINT}	B-Y black Adj.: 0/15 R-Y black Adj.: 0/15 Others: Preset	(1) For B-Y/R-Y Black Adj.:8, measure the DC level of picture period at Pin51,52 that is V_{SBCEN} / V_{SRCEN} . (2) For B-Y Black Adj.:0 /15, measure the DC level change of picture period against V_{SBCEN} at Pin52, that is " $V_{BINTMIN}$ " / " $V_{BINTMAX}$ ". (3) For R-Y Black Adj.:0/15, measure the DC level change of picture period against V_{SRCEN} at Pin51, that is " $V_{RINTMIN}$ " / " $V_{RINTMAX}$ ". (4) Calculate: " ΔV_{BINT} "= $(V_{SBMAX}-V_{SBMIN})/15$ " ΔV_{RINT} "= $(V_{SRMAX} - V_{SRMIN})/15$
	Black adjustment (External) / $V_{BINTMAX}$ / $V_{RINTMAX}$ / $V_{RINTMIN}$ / $V_{RINTMIN}$ Black adjustment sensitivity External / ΔV_{BINT} / ΔV_{RINT}	B-Y black Adj.: 0/15 R-Y black Adj.: 0/15 DemoP; 00 Cont; 7F Color; 40 Ymute; 1 CbCrSW; 1 Others: Preset	(1) For B-Y/R-Y Black Adj.:8, measure the DC level of picture period at Pin12,14 that is V_{SBCEN} / V_{SRCEN} . (2) For B-Y Black Adj.:0 /15, measure the DC level change of picture period against V_{SBCEN} at Pin14, that is " $V_{BEXTMIN}$ " / " $V_{BEXTMAX}$ ". (3) For R-Y Black Adj.:0/15, measure the DC level change of picture period against V_{SRCEN} at Pin12, that is " $V_{REXTMIN}$ " / " $V_{REXTMAX}$ ". (4) Calculate: " ΔV_{BINT} "= $(V_{BEXTMAX} - V_{BEXTMIN}) / 15$ " ΔV_{RINT} "= $(V_{REXTMAX} - V_{REXTMIN}) / 15$
C8	fsc Continuous Wave Output Level / V_{CW}	Others: Preset	(1) Input a 4.43MHz PAL rainbow color-bar (300mV(p-p), burst:chroma=1:1) with sync into Pin61. (2) Measure the amplitude of Pin34 output that is " V_{CW} ".
C9	SECAM CbCr output amplitude / VBS / VRS	RGB Mute:0 Color System:5 Uni-Color:64 Y Mute:1 Others: preset	(1)Input a 75% color bar(200mV(p-p) at R ID) into Pin61.. (2) Measure the R-Y output amplitude at Pin51, that is "VRS". (3) Measure the B-Y output amplitude at Pin52, that is "VBS".

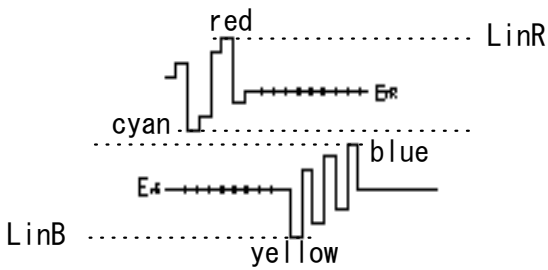
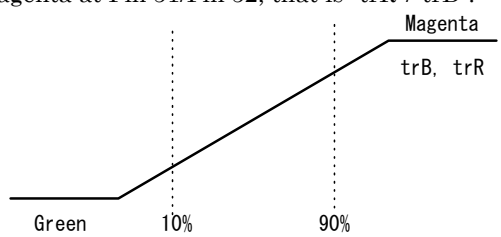
Note	Items/Symbols	Bus conditions	Measurement methods
C10	SECAM CbCr out Relative Amplitude / R/B-S		(1) Calculate : "R/B-S"=VRS/VBS
C11	Color Difference S/N Ratio / SNB-S / SBR-S	RGB Mute:0 Color System:5 Uni-Color:64 Y Mute:1 Others: preset	(1) Input a 200mV(p-p) non-modulated chroma signal into Pin61. (2) Measure the amplitude of noise on Pin51, that is nR. (3) Measure the amplitude of noise on Pin52, that is nB. (4) Calculate : "SNB-S" $=20\log(2\sqrt{2VBS/nB})$ "SNR-S" $=20\log(2\sqrt{2VRS/nR})$
C12	SECAM Linearity / LinB / LinR	Color System:5 Others: preset	(1) Input a 75% color bar(200mV(p-p) at R ID) into Pin61. (2) Measure the amplitude between Black and Cyan/Red, that is VCyan/VRed for pin #51. (3) Measure the amplitude between Black and Yellow/Blue, that is VYellow/VBlue for pin #52. (4) Calculate : "LinR" $=VCync/Vred$ "LinB" $=VYellow/VBlue$ 
C13	Rising-Fall Time / trfB / trfR	Color System:5 Others: preset	(1) Input a 75% color bar(200mV(p-p) at R ID) into Pin61. (2) Measure the rising time(from 10% to 90%) between Green and Magenta at Pin 51/Pin 52, that is "trR"/"trB". 
C14	SECAM ID Sensitivity (Normal Mode) / VSIDHON / VSIDHOFF / VSIDHVON / VSIDHVOFF SECAM ID Sensitivity (Low Mode) / VSIDLHON / VSIDLHOFF / VSIDLHVON / VSIDLHVOFF	S ID Sens:0/1 S ID Mode:0/1 Color System:5 Others: Preset	(1) Input a 75% color bar(200mV(p-p) at R ID) into Pin61.. (2) Set BUS data so that "S ID Sens" is Normal, "S ID Mode" is H. (3) Measure the burst amplitude at which color killer turns on and off, that is "VSIDHON" / "VSIDHOFF". (4) Set BUS data so that "S ID Mode" is H+V. (5) Repeat (3), that is "VSIDHVON" / "VSIDHVOFF". (6) Set BUS data so that "S ID Sens" is Low, "S ID Mode" is H. (7) Repeat (3), that is "VSIDLHON" / "VSIDLHOFF". (8) Set BUS data so that "S ID Mode" is H+V. (9) Repeat (3), that is "VSIDLHVON" / "VSIDLHVOFF".

YUV STAGE (RGB Mute:0 / RGB cut off:128 / DC rest.:2(100%))

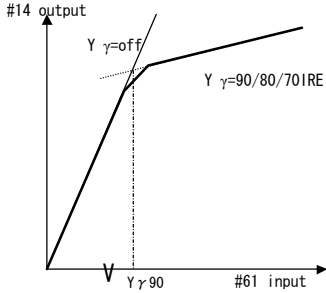
Note	Items/Symbols	Bus conditions	Measurement methods
Y1	Brightness Control / V _{BRTMAX} / V _{BRTCEN} / V _{BRTMIN} Brightness Control resolution / ΔV _{BRT}	Brightness: 0/64/127 Color:0 RGB Mute:0 R cut off:128 DC rest.:2(100%) Others: Preset	(1) Input a 0(IRE) black signal with sync into Pin61. (2) Measure the DC level of picture period at Pin14 for Brightness:127/64/0, that is "VBRTMAX" / "VBRTCEN" / "VBRTMIN". (3) Calculate: "ΔV _{BRT} "=(V _{BRTMAX} -V _{BRTMIN})/127
Y2	Contrast Control for Y / GUCYMAX / GUCYCEN / GUCYMIN	Uni-Color:0/64/127 Color:0 RGB Mute:0 R cut off:128 DC rest.:2(100%) WPS:1(OFF) Others: Preset	(1)Input a PAL color bar (75%) signal with sync into Pin61. (2)Measure the output picture amplitude at Pin14 for contrast:127/64/0, that is VUCYMAX / VUCYCEN / VUCYMIN. (3)Calculate: "GUCYMAX" $=20 \cdot \log(VUCYMAX/0.35)$ "GUCYCEN" $=20 \cdot \log(VUCYCEN/0.35)$ "GUCYMIN" $=20 \cdot \log(VUCYMIN/0.35)$
Y3	Sharpness Control / GSHMAX / GSHCEN / GSHMIN	Sharpness:0/32/63 Uni-Color:64 Color:0 RGB Mute:0 R cut off:128 DC rest.:2(100%) Others: Preset	(1)Input a 0.5V(p-p) sweep signal with sync into Pin61. (2)Measure the output picture amplitude for 100kHz at Pin14 that is V _{SH100k} . (3)Measure the output picture amplitude for FSHP when Sharpness is max.,center and min. that are V _{SHMAX} , V _{SHCEN} and V _{SHMIN} . (4)Calculate: "GSHMAX" $=20 \cdot \log(VSHMAX/VSH100k)$ "GSHCEN" $=20 \cdot \log(VSHCEN/VSH100k)$ "GSHMIN" $=20 \cdot \log(VSHMIN/VSH100k)$
Y4	Sharpness Peaking Frequency / FSHP	Sharpness:63 Uni-Color:63 Color:0 RGB Mute:0 R cut off:128 DC rest.:2(100%) Coring=0/1 Others: Preset	(1) Input a 0.5V(p-p) sweep signal with sync into Pin61. (2) Set the IICBUS switch of coring to 1 (3) Measure the frequency at which the Pin14 output amplitude is Max. that is "FSHP". (4) Set the IICBUS switch of coring to 0 (5) Measure the frequency at which the Pin14 output amplitude is Max. that is "FSHPoff". G _{COR} $=20 \cdot \log(FSHPoff / FSHP)$
Y5	Y γ correction start point / V _{Yγ 70} / V _{Yγ 80} / V _{Yγ 90} Y γ correction curve / G _{Yγ}	Uni-Color:127 Color:0 RGB Mute:0 R cut off:128 DC rest.:2(100%) γ point:0/1/2/3 WPS:1(OFF) Others: Preset	(1) Input a gray raster with sync to Pin61. (2) Set BUS data so that γ point is 90IRE. (3) Increasing a video amplitude of input from 50(IRE), measure a video amplitude as the figure below, that is "VY γ 90" (4) Set BUS data so that γ point is 80IRE.And repeat (3), that is "VY γ 80". (5) Set BUS data so that γ point is 70IRE.And repeat (3), that is "VY γ 70". (6) From the measurement in the above, find gain of the portion that the γ correction has an effect on. 

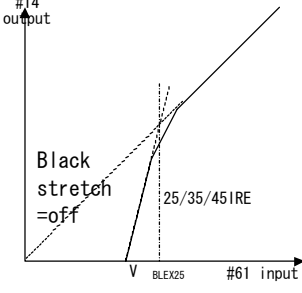
Note	Items/Symbols	Bus conditions	Measurement methods
Y6	Black Expansion Start Point / V_{BLEX25} / V_{BLEX35} / V_{BLEX45} Black Expansion AMP Gain / G_{BLEX}	Uni-Color:127 Color:0 Black stretch: 0/1/2/3 RGB Mute:0 R cut off:128 DC rest.:2(100%) Others: Preset	(1)Input a gray raster with sync to Pin61. (2)Set black stretch to 25(IRE). (3)Decreasing Y amplitude of input from 50(IRE), measure a Y amplitude as the figure below, that is " V_{BLEX25} " (4)Set black stretch to 35(IRE)/45(IRE). (5)Repeat (3), that is " V_{BLEX35} ", " V_{BLEX45} ". (6)Find gain of the portion that the black stretch has an effect on. 
Y7	DC Restoration Gain / $V_{Dcrest120}$ / $V_{Dcrest90}$ / $V_{Dcrest\ step}$	Uni-Color:127 Color:0 DC rest.: 0/1/2/3 RGB Mute:0 R cut off:128 Others: Preset	(1) Input a 100(IRE)(=0.7Vp-p) white signal with sync into Pin38&39. (2) Set DC rest. to 10. (3) Measure a Y amplitude of pin20 output that is V_{100} . (4) Set DC rest to 00. (5) Measure a Y amplitude of pin20 output that is V_{120} . (6) Calculate, " $V_{dcrest120}$ " = $(V_{120}/V_{100}) \times 100$ (7) Set DC rest to 11. (8) Repeat (5)&(6), that is " $V_{dcrest90}$ ". (9) Calculate, " $V_{dcrest\ step}$ " = $(V_{dcrest120} - V_{dcrest90})/4$
Y8	WPS Level / V_{WPS}	Uni-Color:127 Brightness:63 Color:0 RGB Mute:0 R cut off:128 DC rest.:2(100%) WPS:0/1 Others: Preset	(1) Input a 120(IRE) ramp signal with sync into Pin61. (2) Measure the DC voltage from cut-off level to peak(at which output signal is clipped) that is " V_{WPS} ".
Y9	VSM Peak Frequency / F_{VSM}	RGB Mute:0 VSM gain:3 Others: Preset	(1) Input 100mV(p-p) sweep signal to pin61(Y in). (2) Measure the peak point frequency " F_{VSM} " at pin18(VSM OUT) by using a spectrum analyzer.
Y10	VSM Gain / G_{VSM0} / G_{VSM-3} / G_{VSM-10} / G_{VSMOFF}	RGB Mute:0 c-trap=off VSM gain: 0/1/2/3 Others: Preset	(1) Input 100mV(p-p) FVSM sine wave signal (see Y9) to pin61(Y in). (2) Set VSM Gain (0/1/2/3) and measure the amplitude at pin18(VM OUT),that is " V_{VM0} " / " V_{VM-3} " / " V_{VM-10} " / " V_{VM-OFF} ". (3) Calculate, $G_{VSM0} = 20 * \log(V_{VM0}/0.1)$ $G_{VSM-3} = 20 * \log(V_{VM-3}/0.1)$ $G_{VSM-10} = 20 * \log(V_{VM-10}/0.1)$ $G_{VSMOFF} = 20 * \log(V_{VM-off}/0.1)$

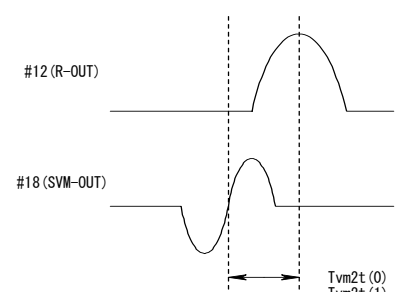
Note	Items/Symbols	Bus conditions	Measurement methods
Y11	VSM Phase / T_{VMFP} / T_{VM2T}	RGB Mute:0 VSM gain:7 Ysm Mode:0 Uni-color : 127 Sharpness : Variable Others: Preset	<ol style="list-style-type: none"> Input 700mV(p-p) FVSM 2T pulse to pin61 (Y in). Set the BUS data of contrast to the maximum and increase the BUS data of Sharpness from the minimum to a value where pin14 (B OUT) waveform is not distorted. Measure the phase difference between the timing at the center level of pin18(B OUT) and the timing at peak level of pin18(VSM OUT) which responds the pin61 input., that is TVMFP. In case that pin61 input signal is 2T pulse, the phase difference is T_{VM2T} 
Y12	VSM Ys Mute Threshold Voltage / V_{VMMLK}	RGB Mute:0 VSM gain:3 Others: Preset	<ol style="list-style-type: none"> Input 100mV(p-p) F_{VSM} sine wave signal (see Y9) to pin61(Y in). Apply dc voltage for pin15(Ysm) and increase the voltage from 0V. Measure the power supply voltage when pin18(VSM OUT) output disappears, that is V_{VMMLK}.
UV1	Tint control range / $\Delta \theta_{MAX}$ / $\Delta \theta_{MIN}$	RGB Mute:0 Tint:0/64/127 Y Mute:1 contrast:127 Others: Preset	<ol style="list-style-type: none"> Input a 4.43MHz PAL rainbow color-bar (burst:chroma=1:1) with sync into Pin61 Set Tint to 64 and adjust the burst phase so that the 6th bar of Pin14 output is maximum, that is θ_{CEN}. Change Tint to 127/0 and adjust the burst phase so that the 6th bar of Pin20 output is maximum, that is $\theta_{MAX} / \theta_{MIN}$. Calculate: "$\Delta \theta_{MAX}$"=$-(\theta_{443MAX} - \theta_{CEN})$ "$\Delta \theta_{MIN}$"=$-(\theta_{443MIN} - \theta_{CEN})$
UV2	Color Control / G_{COLMAX} / G_{COLMIN}	RGB Mute:0 Color:0/64/127 Y Mute:1 Uni-Color:127 Others: Preset	<ol style="list-style-type: none"> Input a 4.43MHz PAL rainbow color-bar(300mV(p-p), burst:chroma=1:1) with sync into Pin61. Measure the Pin14 amplitude for Color 127/64/0, that is $V_{COLMAX} / V_{COLCEN} / V_{COLMIN}$. Calculate: "$G_{COLMAX}$"=$20 * \log(V_{COLMAX} / V_{COLCEN})$ "G_{COLMIN}"=$20 * \log(V_{COLMIN} / V_{COLCEN})$
UV3	contrast control for UV / G_{UCC}	RGB Mute:0 Uni-Color:0/127 Y Mute:1 Others: Preset	<ol style="list-style-type: none"> Input a 4.43MHz PAL rainbow color-bar(300mV(p-p), burst:chroma=1:1) with sync into Pin38&43. Measure the Pin20 amplitude for Uni-Color 127/0 that is V_{UCCMAX}, and V_{UCCMIN}. Calculate:"G_{UCC}"=$20 * \log(V_{UCCMIN} / V_{UCCMAX})$
UV4	Relative Amplitude (PAL1) / $V_{P1R/B}$ / $V_{P1G/B}$ Relative Amplitude (PAL2) / $V_{P2R/B}$ / $V_{P2G/B}$ Relative Amplitude (NtsC1) / $V_{N1R/B}$ / $V_{N1G/B}$ Relative Amplitude (NTSC2) / $V_{N2R/B}$ / $V_{N2G/B}$	RGB Mute:0 Y Mute:0/1 Uni-Color:127 Others: Preset	<ol style="list-style-type: none"> Input a 100IRE signal with sync into pin61. Adjust G/B drive so that each amplitude of pin12/13/14 output are equal. Set Y Mute to 1. Input a 4.43MHz PAL rainbow color-bar(300mV(p-p), burst:chroma=1:1) with sync into Pin61. Measure the amplitude of Pin12/13/14 output, that is "VPROUT"/ "VPGOUT" / "VPBOUT" Calculate; "$V_{P1R/B}$"=V_{PROUT} / V_{PBOUT} "$V_{P1G/B}$"=V_{PGOUT} / V_{PBOUT} Set 'Demo P' to PAL2/NTSC1/NTSC2. Repeat (6)&(7), that is "$V_{P2R/B}$" / "$V_{P2G/B}$" / "$V_{N1R/B}$" / "$V_{N1G/B}$" / "$V_{N2R/B}$" / "$V_{N2G/B}$".

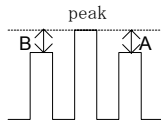
Note	Items/Symbols	Bus conditions	Measurement methods
UV5	Relative Phase (PAL1) / θ_{PR-B} / θ_{PG-B} Relative Phase (PAL2) / θ_{N1R-B} / θ_{N1G-B} Relative Phase (NTSC1) / θ_{N2R-B} / θ_{N2G-B} Relative Phase (NTSC2) / θ_{DR-B} / θ_{DG-B}	RGB Mute:0 Y Mute:1 Uni-Color:127 NTSC Phase: 0/1/2 Others: Preset	(1) Input a 4.43MHz PAL rainbow color-bar(300mV(p-p), burst:chroma=1:1) with sync into Pin61. (2) Observe the Pin12/13/14 output, measure the R/G/B modulation angle ($\theta_{PR}/\theta_{PG}/\theta_{PB}$) according following figure and formula. $\theta_{p*} = \{\theta_{o*} - \text{Arctag}(1/(2A/B + \sqrt{3})) - 15\}$  <p>For θ_{P1R} ; Peak:3rd bar, $\theta_{OR}=90$ For θ_{P1G} ; Peak(negative):4th bar, $\theta_{OG}=240$ For θ_{P1B} ; Peak:6th bar, $\theta_{OB}=0$</p> Calculate; $\theta_{P1R-B} = \theta_{P1R} - \theta_{P1B}$ $\theta_{P1G-B} = \theta_{P1G} - \theta_{P1B}$ (3) Set ' Demo-P' to 01, 10 and 11, and acquire each PAL2, NTSC1 and NTSC2 results with the same measurements.

TEXT STAGE (RGB Mute:0 / RGB cut off:128 / DC rest.:2(100%) / WPS:1(off))

Note	Items/Symbols	Bus conditions	Measurement methods
T1	V-BLK Pulse Output Level / V _{VBLK} H-BLK Pulse Output Level / V _{HBLK}	All: Preset	(1) Input a composite sync signal into Pin61. (2) Measure the DC level of V/H blanking period at Pin14, that is "V _{VBLK} " / "V _{HBLK} ".
T2	RGB Output Black Level (0IRE DC) / V _{BLACK}	RGB Mute:0 Color:0 B cut off:128 DC rest.:2(100%) Others: Preset	(1) Input a 0(IRE) Y signal with sync into Pin61. (2) Measure the DC level of picture period at Pin14, that is "V _{BLACK} ".
T3	RGB Output White Level(100 IRE AC) / V _{WHITE}	RGB Mute:0 B cut off:128 DC rest.:2(100%) Uni-Color:127 Color:0 WPS:1(off) Others: Preset	(1) Input a 100(IRE)(=0.7Vp-p) Y signal with sync into Pin61. (2) Measure the amplitude from 0 to 100IRE at Pin14, that is "V _{WHITE} ".
T4	Cut-off Voltage Variable Range / Δ V _{CUT+} / Δ V _{CUT-}	RGB Mute:0 DC rest.:2(100%) B Cut Off:0/255 Color:64 Brt: 64 Others: Preset	(1) Input a 0(IRE) Y signal with sync into Pin61. (2) Measure the DC level of picture period at Pin14 for B Cut-off:255/0, that is V _{CUTMAX} / V _{CUTMIN} . (3) Calculate; " Δ V _{CUT+} "=V _{CUTMAX} -V _{BLACK} " Δ V _{CUT-} "=V _{CUTMIN} -V _{BLACK}
T5	Drive Control Variable Range / G _{DR+} / G _{DR-}	RGB Mute:0 DC rest.:2(100%) B Drive:0/127 Uni-Color:127 Color:0 WPS:1(OFF) Others: Preset	(1) Input a 100(IRE) (=0.7Vp-p) Y signal with sync into Pin61. (2) Measure the amplitude from 0 to 100IRE at Pin14 for B drive127/0, that is V _{DRMAX} / V _{DRMIN} . (3) Calculate; "G _{DR+} "=20*log(V _{DRMAX} /V _{WHITE}) "G _{DR-} "=20*log(V _{DRMIN} /V _{WHITE})
T6	ABCL Control Voltage Range / V _{ABCLH} / V _{ABCLL} ACL Gain / G _{ACL}	RGB Mute:0 B cut off:128 DC rest.:2(100%) ABL Gain:3 Uni-Color:127 Color:0 WPS:1(OFF) Others: Preset	(1) Input a 100(IRE) (=0.7Vp-p) Y signal with sync into Pin61. (2) Decreasing the Pin31 voltage, measure the voltage at which Pin14 output begins/stops decreasing, that is "V _{ABCLH} " / "V _{ABCLL} ". (3) Measure the minimum amplitude of Pin14 output, that is V _{ACLMIN} . (4) Calculate; "G _{ACL} "=20*log(V _{ACLMIN} /V _{WHITE})
T7	ABL Start Point / V _{ABLP0} / V _{ABLP1} / V _{ABLP2} / V _{ABLP3}	RGB Mute:0 B cut off:128 DC rest.:2(100%) ABL Start Point: 0/1/2/3 ABL Gain:3 Uni-Color:127 Color:0 WPS:1(OFF) Others: Preset	(1) Input a 0(IRE) Y signal with sync into Pin61. (2) For ABL Point 0/1/2/3, decreasing the Pin31 voltage, measure the voltage at which Pin14 output begins decreasing, that is V _{ABL1} /V _{ABL2} /V _{ABL3} /V _{ABL4} . (3) Calculate; "V _{ABLP0} "=V _{ABL1} -V _{ABCLH} "V _{ABLP1} "=V _{ABL2} -V _{ABCLH} "V _{ABLP2} "=V _{ABL3} -V _{ABCLH} "V _{ABLP3} "=V _{ABL4} -V _{ABCLH}
T8	ABL Gain / V _{ABLG0} / V _{ABLG1} / V _{ABLG2} / V _{ABLG3}	RGB Mute:0 B cut off:128 DC rest.:2(100%) ABL Gain: 00/01/10/11 Uni-Color:127 Color:0 WPS:1(OFF) Others: Preset	(1) Input a 0(IRE) Y signal with sync into Pin61. (2) For ABL Gain 0/1/2/3, measure the DC level of picture period at Pin14 when Pin31 voltage is V _{ABCLL} , that is V _{ABL5} /V _{ABL6} /V _{ABL7} /V _{ABL8} . (3) Calculate; "V _{ABLG0} "=V _{ABL5} -V _{BLACK} "V _{ABLG1} "=V _{ABL6} -V _{BLACK} "V _{ABLG2} "=V _{ABL7} -V _{BLACK} "V _{ABLG3} "=V _{ABL8} -V _{BLACK}

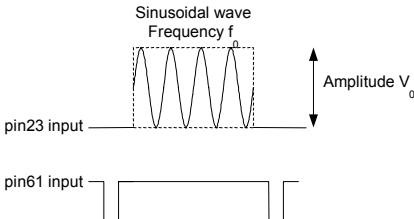
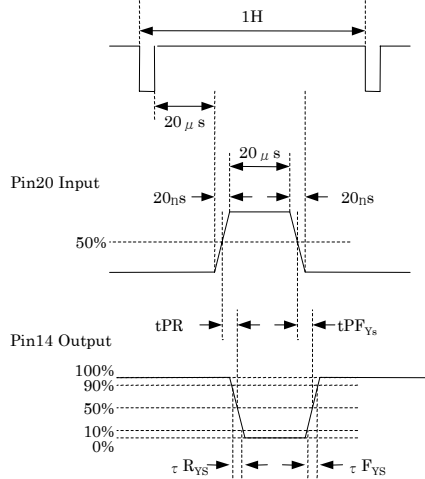
Note	Items/Symbols	Bus conditions	Measurement methods
T9	Analog RGB Dynamic Range / DR _{TX}	RGB Mute:0 B cut off:128 DC rest.:2(100%) RGB Contrast:32 Ysm Mode:1 Others: Preset	<ol style="list-style-type: none"> Input a composite sync signal into Pin61. Supply 2.5V to Pin20. Input a signal of following figure into Pin23. Increasing the amplitude of Pin23 input, measure the amplitude at which the Pin14 amplitude stops increasing, that is "DR_{TX}". 
T11	Analog RGB Brightness Control Characteristic / V _{TXBRMAX} / V _{TXBRCEN} / V _{TXBRMIN}	RGB Mute:0 B cut off:128 DC rest.:2(100%) Brightness: 0/64/127 Others: Preset	<ol style="list-style-type: none"> Supply 3V to Pin15. Connect Pin21, 22 and 23 to GND via a 0.1uF of capacitor. For Brightness 127/64/0, measure the DC level of picture period at Pin14, that is "V_{TXBRMAX}" / "V_{TXBRCEN}" / "V_{TXBRMIN}".
T12	Ysm Mode Switching Level / V _{YSANA} / V _{YSBLK}	RGB Mute:0 Others: Preset	<ol style="list-style-type: none"> Input a composite sync signal into Pin61. Input a signal of NOTE:T9 figure into Pin23. More Increasing the Pin23 voltage, measure the voltage at which the signal inputted into Pin23 appears at Pin14, that is "V_{YSANA}". Increasing the Pin23 voltage, measure the voltage at which the signal disappear at Pin14, that is "V_{YSBLK}".
T13	Analog RGB Mode Transfer Characteristic / τ _{RYS} / t _{PRYS} / τ _{FYS} / t _{PFYS}	RGB Mute:0 B cut off:128 DC rest.:2(100%) Others: Preset	<ol style="list-style-type: none"> Input a 50(IRE) (=0.35Vp-p) Y signal with sync into Pin61. Connect Pin21, 22 and 23 to GND via a 0.1uF capacitor. Measure the Analog RGB Mode Transfer time, according to following figure, 
T14	Cross Talk from Analog RGB to TV / CT _{TX-TV}	RGB Mute:0 B cut off:128 DC rest.:2(100%) contrast:127 Others: Preset	<ol style="list-style-type: none"> Input a composite sync signal into Pin61. Connect Pin61 to GND via a 1uF capacitor. Input a sine wave signal (f=4MHz, Video amplitude=0.5V(p-p)) into Pin23. Supply 0V to Pin20. Measure the amplitude at Pin14, that is V_{TV}. Supply 2.5V to Pin20. Measure the amplitude of 4MHz signal at Pin14, that is V_{TX}. Calculate: "CT_{TX-TV}"=20*log(V_{TV}/ V_{TX})

Note	Items/Symbols	Bus conditions	Measurement methods
T15	Cross Talk from TV to Analog RGB / CT _{TV-TX}	RGB Mute:0 R cut off:128 DC rest.:2(100%) Ysm Mode:1 Uni-color:127 RGB contrast:63 Others: Preset	(1) Input a sine wave signal (f=4MHz, Video amplitude=0.5V(p-p)) with sync into Pin61. (2) Connect Pin21, 22 and 23 to GND via a 0.1uF capacitor. (3) Supply 2.5V to Pin20. (4) Measure the amplitude at Pin14, that is V _{TX} . (5) Supply 0V to Pin20. (6) Measure the amplitude of 4MHz signal at Pin14, that is V _{TV} . (7) Calculate: "CT _{TV-TX} "=20*log(V _{TX} / V _{TV})
T17	Analog RGB/RGB Output Voltage Axes Difference / ΔV _{R-G} / ΔV _{G-B} / ΔV _{B-R}	RGB Mute:0 R/G/B cut off:128 Brightness:63 DC rest.:2(100%) Color:0 Uni-color:127 Others: Preset	(1)Input a 0IRE signal with sync into Pin61. (2)Connect Pin21, 22 and 23 to GND via 0.01 μ F. (3)Measure the DC level of picture period at Pin12, 13 and 14, that is R _Y /G _Y /B _Y . (4)Supply Pin15 to 2.5V. (5) Measure the DC level of picture period at Pin12, 13 and 14, that is R _T /G _T /B _T . (6)Calculate: $\Delta R = R_T - R_Y$ $\Delta G = G_T - G_Y$ $\Delta B = B_T - B_Y$ $\text{"}\Delta V_{R-G}\text{"} = \Delta R - \Delta G$ $\text{"}\Delta V_{G-B}\text{"} = \Delta G - \Delta B$ $\text{"}\Delta V_{B-R}\text{"} = \Delta B - \Delta R$
T18	RGB Mute DC level V _{RGBMUTE}	RGB Mute:0/1 R/G/B cut off:128 Brightness:63 DC rest.:2(100%) Color:0 Uni-color:127 Others: Preset	(1)Input a 0IRE signal with sync into Pin61. (2)Set the IICBUS switch of RGBMUTE to 1 (3)Connect Pin21, 22 and 23 to GND via 0.01 μ F. (4)Measure the DC level of picture period at Pin 14, that is V _{RGBMUTE} (5)Reset RGBMUTE to 0 and set Blueback to 1 (6)Measure the DC level of picture period at Pin 14, that is V _{BB}
UV6	Half Tone Characteristics for Y / G _{HTY}	Ysm Mode:0 Uni-Color:127 Color:0 RGB Mute:0 R cut off:128 DC rest.:2(100%) Others: Preset	(1) Input a 100(IRE) (=0.7Vp-p) white signal with sync into Pin61. (2) Measure the output picture amplitude at Pin14 that is V _{HTYOFF} . (3) Supply Pin20 1.5V. (4) Measure the output picture amplitude at Pin14 that is V _{HTYON} . Calculate:"G _{HTY} "=20*log(V _{HTYON} /V _{HTYOFF})
UV7	Half Tone Characteristics for C / G _{HTC}	RGB Mute:0 Y Mute:1 Uni-Color:127 Others: Preset	(1) Input a 4.43MHz PAL rainbow color-bar(300mV(p-p), burst:chroma=1:1) with sync into Pin61. . (2) Supply Pin15 1.5V and measure the amplitude of Pin14 output, that is V _{PBHTC} . (3) Calculate: (V _{PBOUT} :see C7) "G _{HTC} "=20*log(V _{PBHTC} /V _{PBOUT})

DEF STAGE

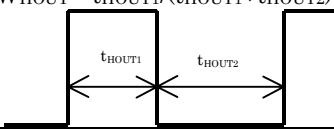
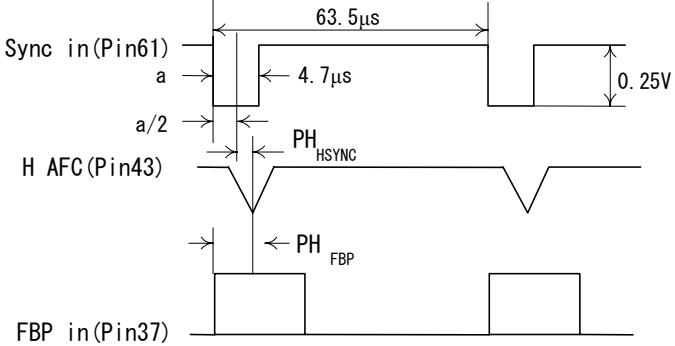
Note	Items/Symbols	Bus conditions	Measurement methods
D1	AFC Inactive Period / $T_{50AFCOFF}$ / $T_{60AFCOFF}$	All: Preset	(1) Input a 50Hz/60Hz composite sync signal into Pin61. (2) Measure " $T_{50AFCOFF}$ " / " $T_{60AFCOFF}$ " at Pin43. (cf. Fig.D1)
D2	H-OUT Start Voltage / V_{HON}	All: Preset	(1) Let Pin11, 25, 67and 74 be open. (2) Increasing Pin45 voltage, measure the voltage at which H OUT pulse appears at Pin39, that is " V_{HON} ".
D3	H-OUT Pulse Duty / W_{HOUT}	All: Preset command IIC read	(1) Measure t_{HOUT1} & t_{HOUT2} at Pin39. (2) Calculate ; " $W_{HOUT} = t_{HOUT1} / (t_{HOUT1} + t_{HOUT2}) * 100$ " 
D4	H-OUT Freq. on AFC Stop Mode / $F_{HAFCOFF}$	AFC Gain:11 (OFF) Others: Preset	(1) Input a 50Hz composite sync signal into Pin61. (2) Measure the H OUT frequency at Pin32, that is " $F_{HAFCOFF}$ ".
D5	Horizontal Free-run Frequency / F_{HFR}	V-Freq:001/010 Others: Preset	(1) Measure the H OUT frequency at Pin61, that is " F_{H50FR} " / " F_{H60FR} ".
D6	Horizontal Freq. Variable Range / F_{HMAX} / F_{HMIN}	All: Preset	(1) Connect Pin43 to Vcc via a 10k Ω and measure the H OUT frequency at Pin39, that is " F_{HMIN} ". (2) Connect Pin43 to GND via a 68k Ω and measure the H OUT frequency at Pin39, that is " F_{HMAX} ".
D7	Horizontal Freq. Control Sensitivity / β_{HAFC}	All: Preset	(1) Measure the Pin39 voltage at which H OUT frequency is 15.734kHz, that is V_{H15734} . (2) Measure the H OUT frequency when Pin43 voltage is $V_{H15734} + 50mV / V_{H15734} - 50mV$, that is F_{HLOW} / F_{HHIGH} . (3) Calculate; " $\beta_{HAFC} = (F_{HHIGH} - F_{HLOW}) / 100$ "
D8	Horizontal Pull-in Range / ΔF_{HPH} / ΔF_{HPL}	All: Preset	(1) Input a composite sync signal into Pin61. (2) Decreasing the horizontal frequency from 17kHz, measure the frequency at which H OUT synchronized with Sync in(Pin61), that is F_{HPH} . (3) Increasing the horizontal frequency from 14kHz, measure the frequency at which H OUT synchronized with Sync in(Pin61), that is F_{HPL} . (4) Calculate; " $\Delta F_{HPH} = F_{HPH} - 15734$ " " $\Delta F_{HPL} = 15625 - F_{HPL}$ "
D9	H-OUT Voltage / V_{HOUTH} / V_{HOUTL}	All: Preset	(1) Measure the high level of H OUT at Pin39, that is " V_{HOUTH} ". (2) Measure the low level of H OUT at Pin39, that is " V_{HOUTL} ".
D10	Horizontal Freq. Dependence on Vcc / ΔF_{HVCC}	All: Preset	(1) Measure the H OUT frequency when H Vcc(Pin45) is 8.5V/9.5V, that is F_{HVCCH} / F_{HVCCL} . (2) Calculate; " $\Delta F_{HVCC} = (F_{HVCCH} - F_{HVCCL}) / 1$ "
D11	FBP Phase / PH_{FBP} H-Sync. Phase / PH_{HSYNC}	All: Preset	(1) Input a composite sync signal into Pin61. (2) According to the following figure, measure " PH_{FBP} " & " PH_{HSYNC} ". 

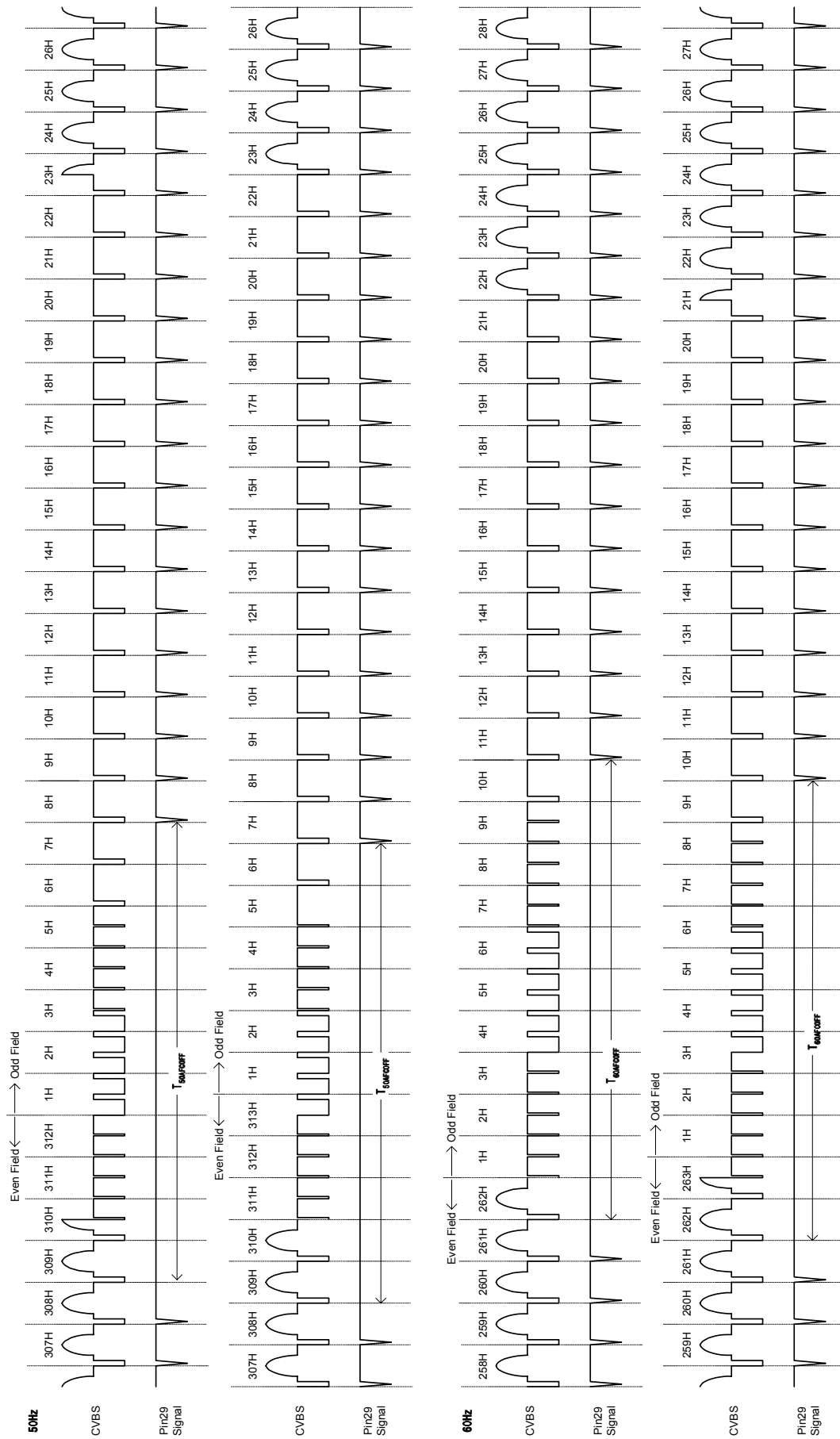
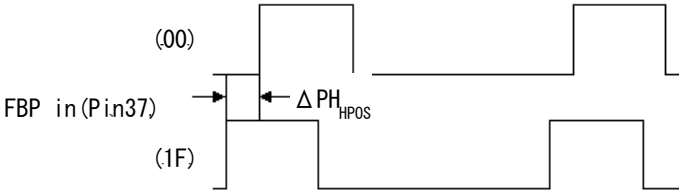
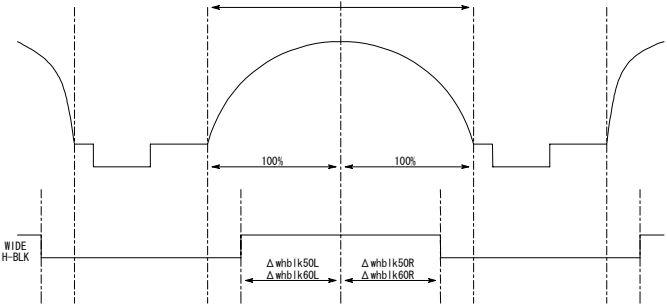
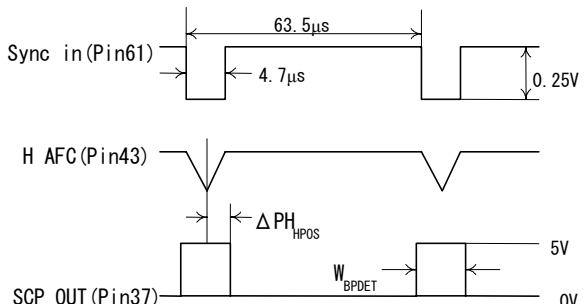

Fig. D1

Note	Items/Symbols	Bus conditions	Measurement methods
D12	Horizontal Position Variable Range / ΔPH_{HPOS} / ΔPH_{HPOS+} / ΔPH_{HPOS-}	H Position:0/31 Others: Preset	<p>(1) Input a composite sync signal into Pin61.</p> <p>(2) Changing BUS data of "Horizontal Position" from 0 to 31, measure "ΔPH_{HPOS}" according to the following figure.</p>  <p>(3) Measure the H phase where the pin #73 (Hcorr) is opened and the HPOS is 16</p> <p>(4) Measure the H phase shift from (3) when supply 5.5V for pin #73, that is ΔPH_{HPOS+}.</p> <p>(5) Measure the H phase shift from (3) when supply 0.5V for pin #73, that is ΔPH_{HPOS-}.</p>
D13	AFC-2 Pulse Threshold Level / V_{AFC2}	All: Preset	<p>(1) Input a composite sync signal into Pin61.</p> <p>(2) Decreasing the FBP high level, measure the DC level at which H OUT phase changes against Sync in(Pin61) phase, that is "V_{AFC2}".</p>
D14	H-BLK Pulse Threshold Level / V_{HBLK} $\Delta W_{WHBLK50L}$ $\Delta W_{WHBLK50R}$ $\Delta W_{WHBLK60L}$ $\Delta W_{WHBLK60R}$	RGB Mute:0 contrast:127 Others: Preset	<p>(1) Input a composite sync signal into Pin61.</p> <p>(2) Increasing the FBP high level, measure the DC level at which H blanking begins to work, that is "V_{HBLK}".</p> <p>(3) Measure as the figure below when the IICBUS of 'W-HBLK=1' and when input 50/60Hz of V freq.</p> 
D15	Black Peak Det. Stop Period (H) / PH_{BPDET} / W_{BPDET}	TEST:00001000 Black Stretch:01 Others: Preset	<p>(1) Input a composite sync signal into Pin61.</p> <p>(2) According to the following figure, measure "PH_{BPDET}" & "W_{BPDET}".</p> 

Note	Items/Symbols	Bus conditions	Measurement methods
D16	Gate Pulse Start Phase / PH _{GP} Gate Pulse Width / W _{GP}	All: Preset	<p>(1) Input a composite sync signal into Pin61. (2) According to the following figure, measure "PH_{GP}" & "W_{GP}".</p> <p>Sync in (Pin61) — 63.5 μs — 4.7 μs — 0.25V</p> <p>H AFC (Pin43) — PH_{GP} — W_{GP} — 5V — 0V</p> <p>SCP OUT (Pin37)</p>
D18	Vertical Free-run Frequency / F _{VAUFR50} / F _{VAUFR60} / F _{V50FR} / F _{V60FR}	V-Freq: 0/1/2 Others: Preset	<p>(1) Input a 50Hz composite sync signal into Pin61. (2) Set V-Freq to 0. (3) For no input, measure the frequency of V Ramp at Pin46, that is "F_{VAUFR50}". (4) Input a 60Hz composite sync signal into Pin61. (5) Repeat (2)&(3), that is "F_{VAUFR60}". (6) Set V-Freq. To 1/2, repeat (2), that is "F_{V50FR}" / "F_{V60FR}".</p>
D19	Gate Pulse V-Masking Period / T _{50GPM} / T _{60GPM}	All: Preset	<p>(1) Input a 50Hz/60Hz composite sync signal into Pin61. (2) Measure "T_{50GPM}" / "T_{60GPM}" at Pin37. (cf. Fig.D19)</p>

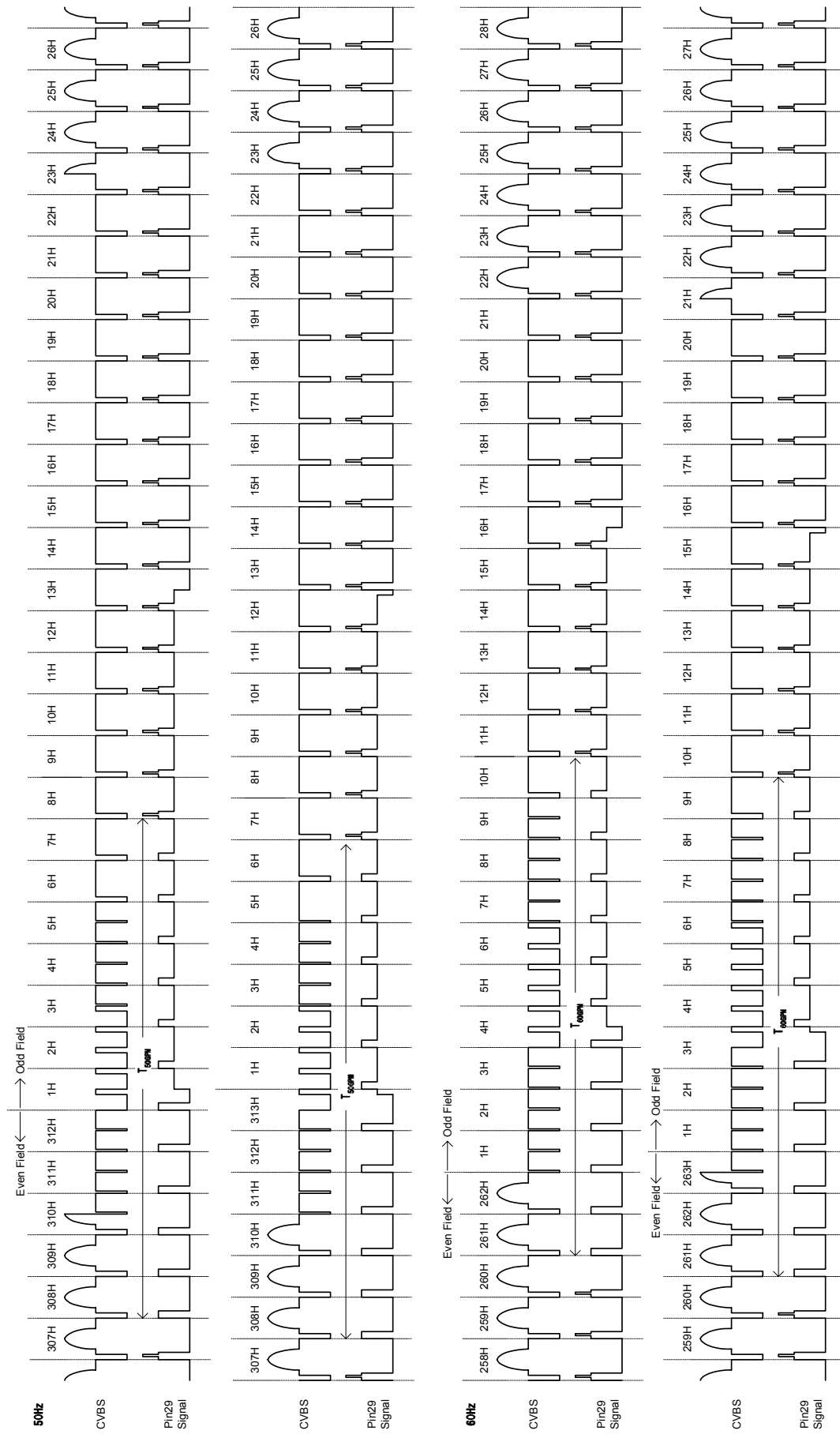
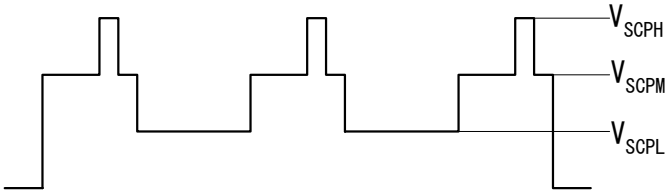

Fig. D19

Note	Items/Symbols	Bus conditions	Measurement methods
D20	V. Ramp DC on Service Mode / V _{NOVRAMP}	V STOP:1 Others: Preset	(1) Set V STOP to 1. (2) Measure the DC level of Pin47, that is "V _{NOVRAMP} ".
D21	Vertical Pull-in Range (Auto) / F _{VPAUL} / F _{VPAUH} Vertical Pull-in Range (50Hz) / F _{VP50L} / F _{VP50H} Vertical Pull-in Range (60Hz) / F _{VP60L} / F _{VP60H}	V-Freq:0/1/2 Others: Preset	(1) Input a composite sync signal into Pin61. (2) For V-Freq 0/1/2, increasing the input vertical period from 220H by 0.5H step, measure the period at which input signal synchronized with V Ramp(Pin46), that is "F _{VPAUL} " / "F _{VP50L} " / "F _{VP60L} ". (3) For V-Freq 0/1/2, decreasing the input vertical period from 360H by 0.5H step, measure the period at which input signal synchronized with V Ramp, that is "F _{VPAUH} " / "F _{VP50H} " / "F _{VP60H} ".
D22	Vertical Period on Fixed Mode / T _{V3125} / T _{V2625} / T _{V313} / T _{V263}	V-Freq:4/5/6/7 Others: Preset	(1) For V-Freq 4/5/6/7, measure the vertical period at SCP out (Pin37), that is "T _{V312.5} " / "T _{V262.5} " / "T _{V313} " / "T _{V263} ".
D23	VD Start Phase / PH _{50VD} / PH _{60VD} VD Width / W _{50VD} / W _{60D}	All: Preset	(1) Input a 50Hz/60Hz composite sync signal into Pin61. (2) Measure "PH _{50VD} " / "W _{50VD} " and "PH _{60VD} " / "W _{60VD} " at Pin40. (cf. Fig.D23)
D24	V-BLK Start Phase / PH _{50VBLK} / PH _{60VBLK} V-BLK Width / W _{50VBLK} / W _{60VBLK}	All: Preset	(1) Input a 50Hz/60Hz composite sync signal into Pin61. (2) Measure "PH _{50VBLK} " / "W _{50VBLK} " and "PH _{60VBLK} " / "W _{60VBLK} " at Pin14.
D25	Sand Castle Pulse Level / V _{SCPH} / V _{SCPM} / V _{SCPL}	All: Preset	(1) Measure "V _{SCPH} " / "V _{SCPM} " / "V _{SCPL} " at Pin37. 
D26	V Ramp Amplitude / V _{VRAMP} / V _{VOUT} / V _{VOUT MAX} / V _{VOUT MIN} / V _{OUTDC}	All: Preset	(1) Measure the V Ramp amplitude at Pin46, that is "V _{VRAMP} ". (2) Measure the V Ramp amplitude at pin #47, that is "V _{OUT} ". (3) Measure the V Ramp increasing ratio at pin #47 at when 'V Size' = Max, that is "R _{VOUT MAX} ". (4) Measure the V Ramp decreasing ratio at pin #47 at when 'V Size' = 01, that is "R _{VOUT MIN} ". (5) Measure the V Ramp dc voltage at pin #47 at when 'V Size' = 00, that is "V _{OUTDC} ". (6) Measure the V Ramp dc voltage at pin #47 at when 'V Size' = 00 and 'V cent'=MAX, let it 'V _{MAXDC} ' "V _{CENT MAX} " = ('V _{MAXDC} ' - "V _{OUTDC} ") / "V _{OUT} " (7) Measure the V Ramp dc voltage at pin #47 at when 'V Size' = 00 and 'V cent'=Min, let it 'V _{MINDC} ' "V _{CENT MAX} " = ('V _{MINDC} ' - "V _{OUTDC} ") / "V _{OUT} "

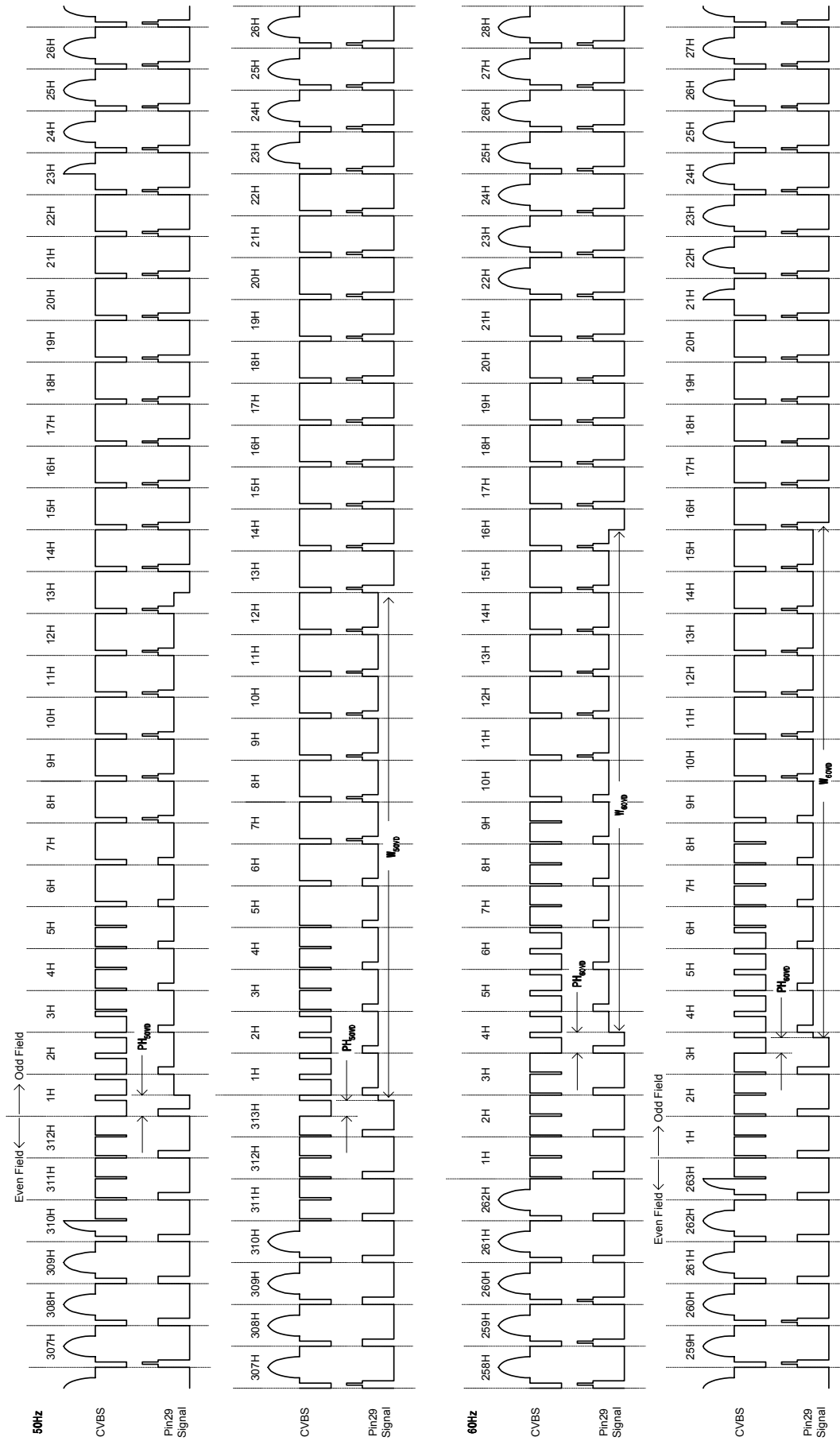
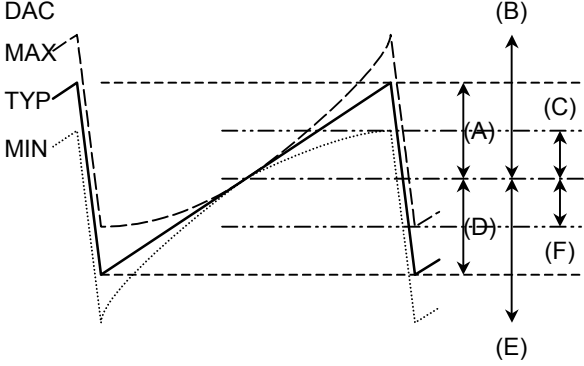
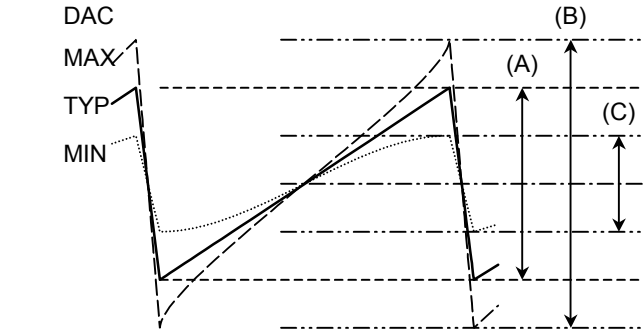
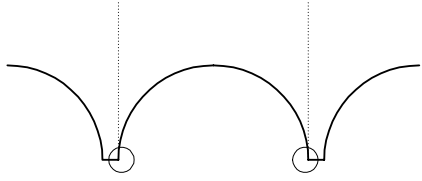
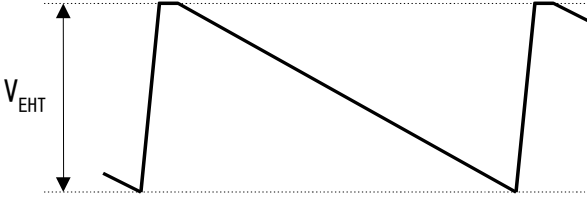
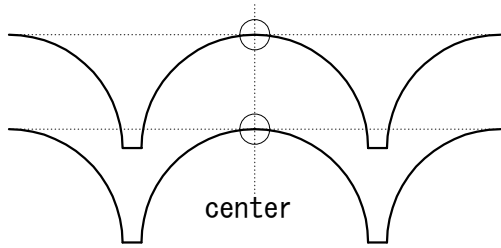
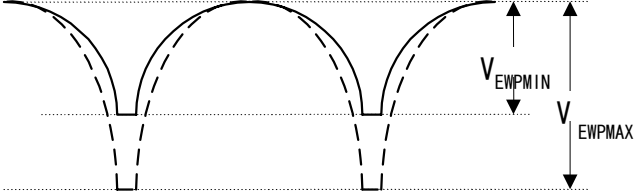
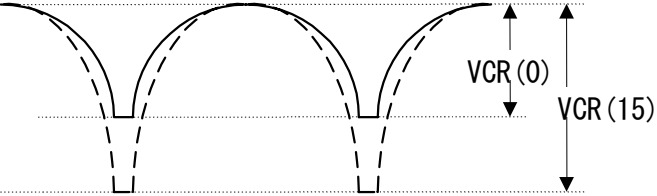
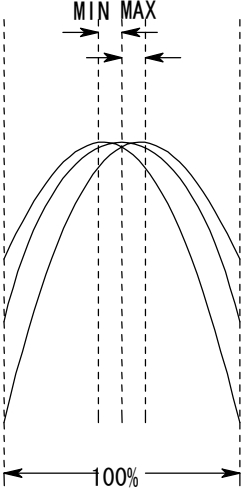
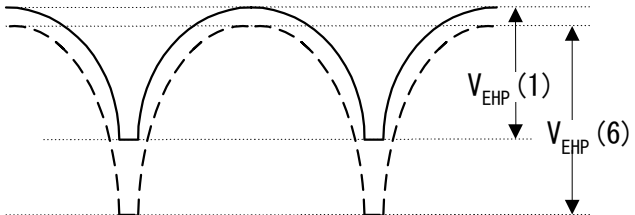

Fig. D23

Note	Items/Symbols	Bus conditions	Measurement methods
D27	Vertical Linearity Variable Range / ΔV_{LIN}	V Linearity:0/8/15 Others: Preset	<p>(1) Supply 6V into pin28(EHT in).</p> <p>(2) Measure the levels of the A - F in the following figure in setting the V-Lin for each.</p> <p>(3) Calc the "V-LIN" with this formula. $V-Lin = \{(B - C) + (E - F)\} / \{2 \times (A + D)\} \times 100\%$</p>  <p>The graph shows a DAC output waveform with three levels: MAX, TYP, and MIN. A solid line represents the ideal linear response, while a dashed line shows the actual measured response. Six horizontal dashed lines are drawn across the waveform, labeled (A) through (F) on the right. (A) and (D) are the vertical distances between the MAX and TYP levels, and between the TYP and MIN levels, respectively. (B) and (E) are the vertical distances between the MAX and (A) levels, and between the (F) and MIN levels, respectively. (C) and (F) are the vertical distances between the (A) and (F) levels.</p>
D28	Vertical S Correction Variable Range / $\Delta V_{S(+)}$ / $\Delta V_{S(-)}$	V S Corr.:0/8/15 Others: Preset	<p>(1) Supply 6V into pin28(EHT in).</p> <p>(2) Measure the levels of the A - F in the following figure in setting the V-S for each.</p> <p>(3) Calc the "V-LIN" with this formula. $V-S(+) = (A - B) / A \times 100\%$ $V-S(-) = (A - C) / A \times 100\%$</p>  <p>The graph shows a DAC output waveform with three levels: MAX, TYP, and MIN. A solid line represents the ideal linear response, while a dashed line shows the actual measured response. Three horizontal dashed lines are drawn across the waveform, labeled (A) through (C) on the right. (A) is the vertical distance between the MAX and TYP levels. (B) is the vertical distance between the MAX and (A) levels. (C) is the vertical distance between the (A) and TYP levels.</p>

Note	Items/Symbols	Bus conditions	Measurement methods
D29	Vertical Amplitude EHT Correction / ΔV_{EHT}	Parabola correction: 32/63 Trapezium correction: 0~31 V.EHT:0/7 Others: Preset	<p>(1) Set the BUS data of Parabola correction to 0(MAX),and change the BUS data of Trapezium correction so that the parabola waveform at pin41(EW OUT) is symmetrical.</p>  <p>(2) Set the BUS data of Parabola correction to 32(CEN). (3) Supply 1V into pin28(EHT in). (4) Set the BUS data of V.EHT to 0(MIN). (5) Measure the amplitude of waveform at pin47(V out),that is $V_{EHT}(00)$. (6) Set the BUS data of V.EHT to 7(MAX). (7) Measure the amplitude of waveform at pin47(V out),that is $V_{EHT}(07)$. (8) $\Delta V_{EHT} = (V_{EHT}(00) - V_{EHT}(07)) / V_{EHT}(00) \times 100\%$</p>  <p style="text-align: center;">Pin47 Waveform</p>
D30	E-W H Size / $V_{EWDCMAX}$ / $V_{EWDCMIN}$	Parabola correction: 32/63 Trapezium correction: 0~31 Horizontal size:0/63 Others: Preset	<p>(1) Set the BUS data of Parabola correction to 0(MAX),and change the BUS data of Trapezium correction so that the parabola waveform at pin33(EW OUT) is symmetrical. (2) Set the BUS data of Parabola correction to 32(CEN). (3) Supply 6V into pin28(EHT in). (4) Set the BUS data of Horizontal size to 0(MAX). Measure the voltage at pin33(EW OUT),that is "$V_{EWDCMAX}$". (5) Set the BUS data of Horizontal size to 63(MIN). Measure the voltage at pin33(EW OUT),that is "$V_{EWDCMIN}$".</p>  <p style="text-align: center;">Pin41 Waveform</p>

Note	Items/Symbols	Bus conditions	Measurement methods
D35	E-W Parabolic / $V_{EWP\text{MAX}}$ / $V_{EWP\text{MIN}}$	Parabola correction: 0/63 Trapezium correction: 0~31 Horizontal size:32 Others: Preset	<ol style="list-style-type: none"> (1) Set the BUS data of Parabola correction to 0(MAX),and change the BUS data of Trapezium correction so that the parabola waveform at pin33(EW OUT) is symmetrical. (2) Set the BUS data of Horizontal size to 32(CEN). (3) Supply 6V into pin28(EHT in). (4) Set the BUS data of Parabola correction to 0(MAX). Measure the amplitude of waveform at pin33(EW OUT),that is "$V_{EWP\text{MAX}}$". (5) Set the BUS data of Parabola correction to 63(MIN). Measure the amplitude of waveform at pin33(EW OUT),that is "$V_{EWP\text{MIN}}$".  <p style="text-align: center;">Pin33 Waveform</p>
D36	E-W Corner / $V_{EWCT\text{MAX}}$ / $V_{EWCT\text{MIN}}$ / $V_{EWCB\text{MAX}}$ / $V_{EWCB\text{MIN}}$	Parabola correction:0 Trapezium correction:0~31 Corner correction: 0/15 Others: Preset	<ol style="list-style-type: none"> (1) Set the BUS data of Parabola correction to 0(MAX),and change the BUS data of Trapezium correction so that the parabola waveform at pin33(EW OUT) is symmetrical. (2) Set the BUS data of Parabola correction to 0(MAX). (3) Supply 6V into pin28(EHT in). (4) Set the BUS data of Corner correction to 0. (5) Measure the amplitude of waveform at pin33(EW OUT),that is $V_{CR}(0)$. (6) Set the BUS data of Corner correction to 15. (7) Measure the amplitude of waveform at pin33(EW OUT),that is $V_{CR}(15)$. (8) $V_{COR} = V_{CR}(15) - V_{CR}(0)$  <p style="text-align: center;">Pin33 Waveform</p>

Note	Items/Symbols	Bus conditions	Measurement methods
D37	E-W Trapezium Correction / V_{TRMAX} / V_{TRMIN}	Trapezium correction: 0/31 Others: Preset	<p>(1) Set the BUS data of 'EW Trape' so as to hit the peak at the center of the V period.</p> <p>(2) Set the BUS data of Trapezium correction to 0.</p> <p>(3) Measure the % of the shifts.</p> <p>(4) Set the BUS data of Trapezium correction to 63.</p> <p>(5) Measure the % of the shifts.</p> 
D38	E-W Parabolic EHT Correction / $\Delta V_{EWP EHT}$	Trapezium correction:0~31 H.EHT:7 Others: Preset	<p>(1) Set the BUS data of Parabola correction to 0(MAX),and change the BUS data of Trapezium correction so that the parabola waveform at pin33(EW OUT) is symmetrical.</p> <p>(2) Set the BUS data of H.EHT to 7.</p> <p>(3) Supply 6V into pin28(EHT in).</p> <p>(4) Measure the amplitude of waveform at pin34(EW OUT),that is $V_{EHP}(6)$.</p> <p>(5) Supply 1V into pin28(EHT in).</p> <p>(6) Measure the amplitude of waveform at pin33(EW OUT),that is $V_{EHP}(1)$.</p> <p>(7) $\Delta V_{EWP EHT} = (V_{EHP}(6) - V_{EHP}(1)) / V_{EHP}(6) \times 100\%$</p>  <p style="text-align: center;">Pin33 Waveform</p>

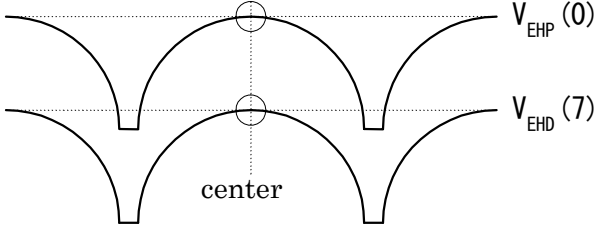
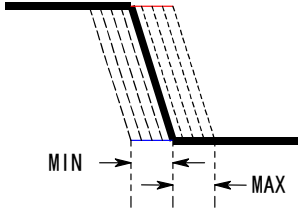
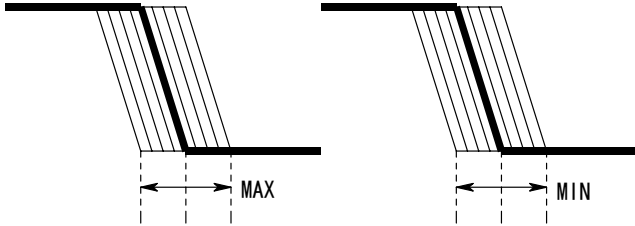
Note	Items/Symbols	Bus conditions	Measurement methods
D39	E-W DC EHT Correction / $V_{EWDCEHT}$	Trapezium correction: 0~31 H.EHT:0/7 Others: Preset	<ol style="list-style-type: none"> (1) Set the BUS data of Parabola correction to 0(MAX),and change the BUS data of Trapezium correction so that the parabola waveform at pin33(EW OUT) is symmetrical. (2) Supply 1V into pin28(EHT in). (3) Set the BUS data of H.EHT to 0. (4) Measure the vertical phase center voltage of waveform at pin33(EW OUT),that is $V_{EHD}(0)$. (5) Set the BUS data of H.EHT to 7. (6) Measure the vertical phase center voltage of waveform at pin33(EW OUT),that is $V_{EHD}(7)$. (7) $V_{EWDCEHT} = V_{EHD}(0) - V_{EHD}(7)$  <p style="text-align: center;">Pin33 Waveform</p>
D40	H-Bow Correction H-Parallelogram Correction / $T_{HBOWMAX}$ / $T_{HBOWMIN}$ / $T_{HPARAMAX}$ / $T_{HPARAMIN}$		<ol style="list-style-type: none"> (1) Let the phase of the HOUT falling edge by to the H sync is Origin when HBAW = 4 (cent). (2) Measure the phase shifting when H BAW= 0 and 7, that is $T_{HBOWMAX} / T_{HBOWMIN}$. (3) Measure the phase shifting when H PARA= 0 and 7, that is $T_{HPARAMAX} / T_{HPARAMIN}$  <p style="text-align: center;">H-Bow Correction</p>  <p style="text-align: center;">H-Parallelogram Correction</p>
D41	Noise Det level V_{NDET3} V_{NDET15}		<ol style="list-style-type: none"> (1) Input CVBS signals with 10MHz of sin wave for #61(CVBS1in) (2) Set the IICBUS of 'Nose Det Level' to 3 (3) Measure the input sin wave amplitude at the level which the Read bus of NOISE det turned to 1, that is $1V_{NDET3}$. (4) Set the IICBUS of 'Nose Det Level' to 15 (5) Measure the same way as (3), that is $1V_{NDET3}$.

11, Evaluation board shema

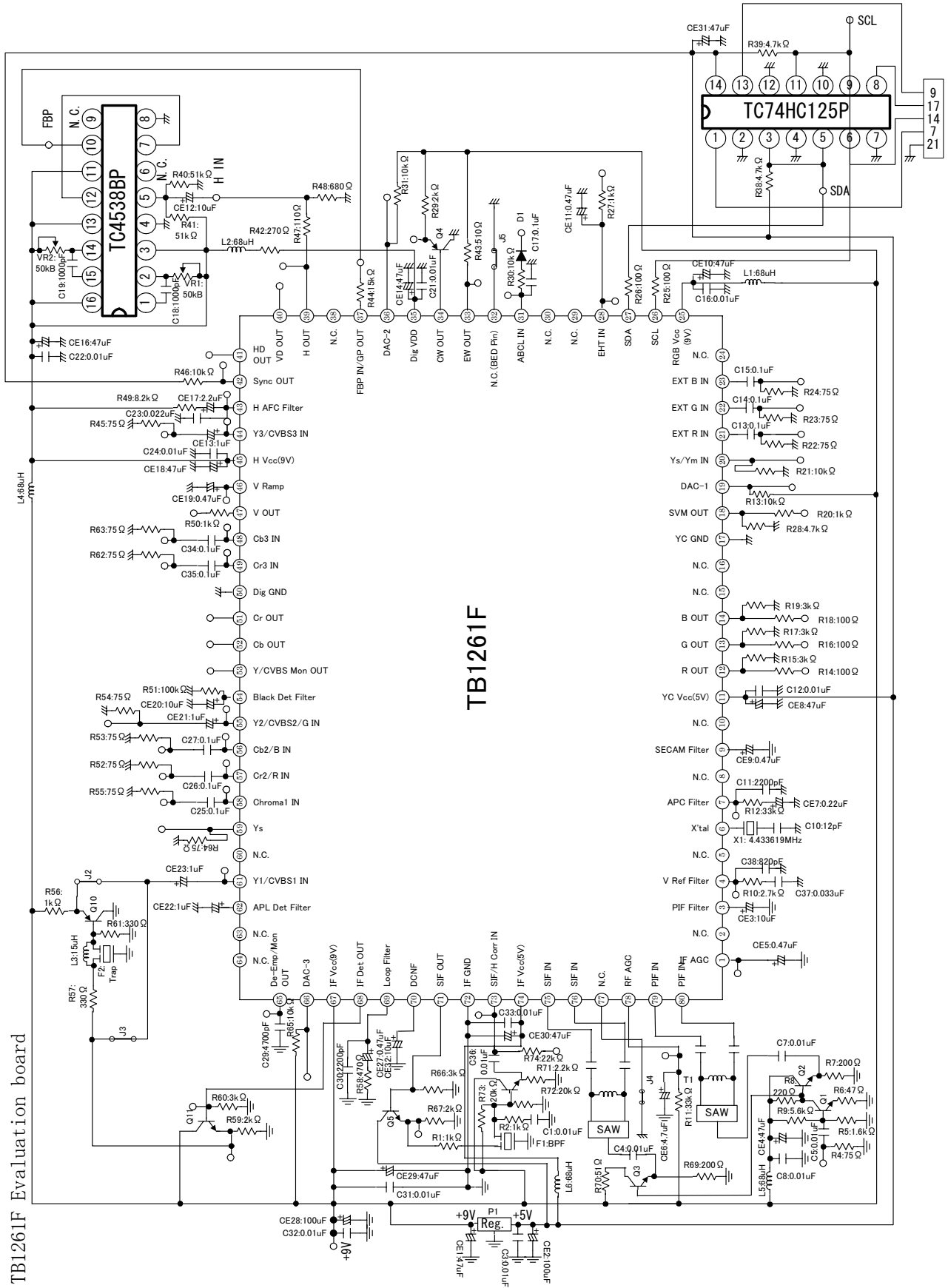

12, Application circuit

TB1261F/62F Application Circuit Diagram

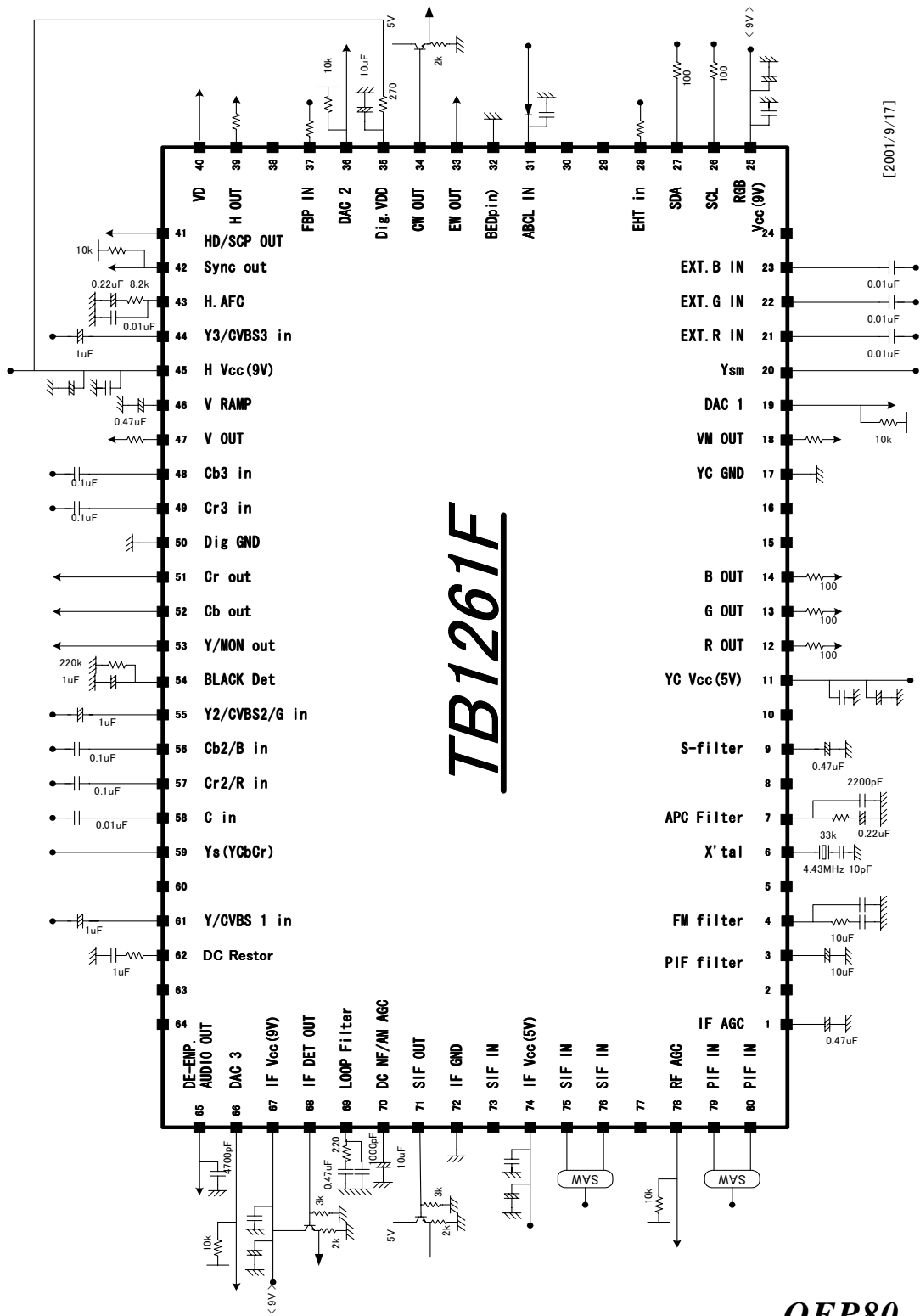

13, OUTLINE DRAWING

QFP80-P-1420-0.80C

Unit : mm

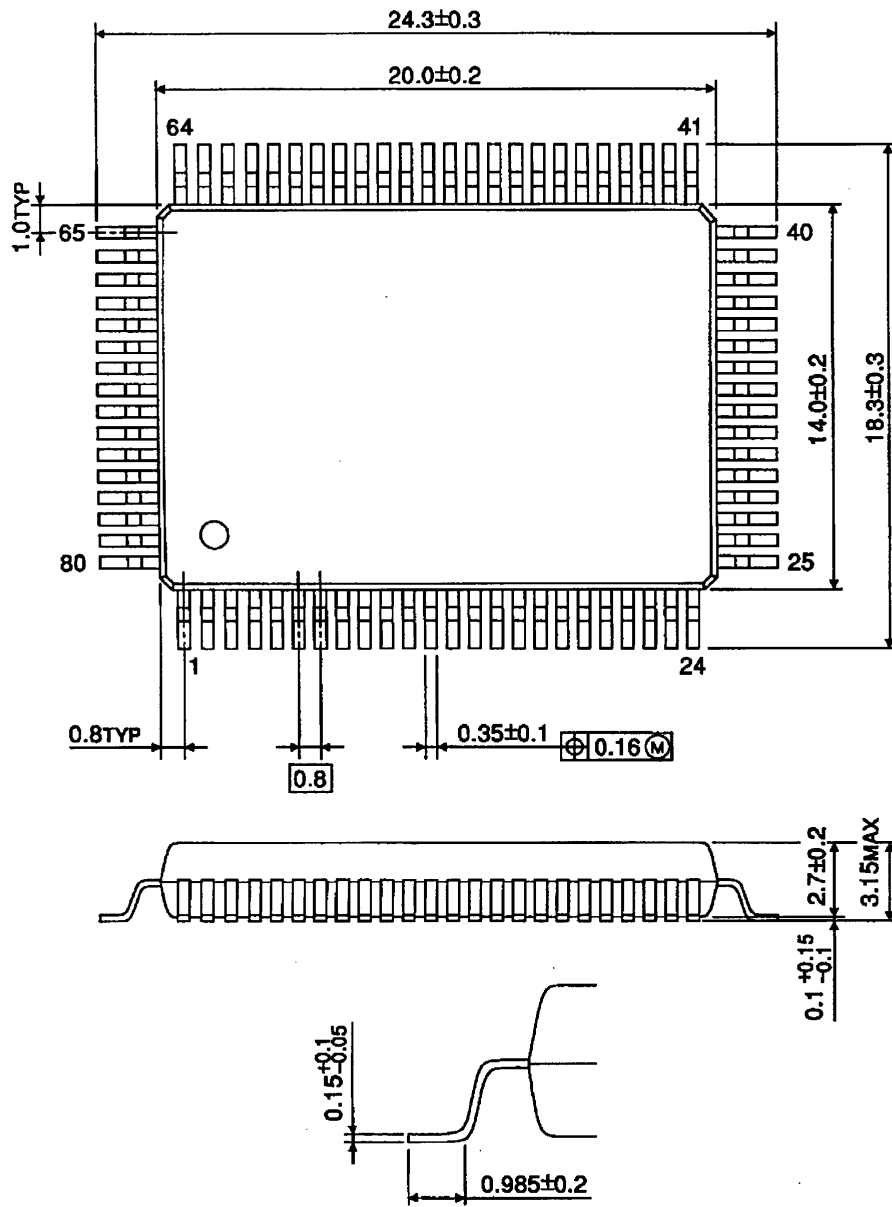

RESTRICTIONS ON PRODUCT USE

000707EBA1

- TOSHIBA is continually working to improve the quality and reliability of its products. Nevertheless, semiconductor devices in general can malfunction or fail due to their inherent electrical sensitivity and vulnerability to physical stress. It is the responsibility of the buyer, when utilizing TOSHIBA products, to comply with the standards of safety in making a safe design for the entire system, and to avoid situations in which a malfunction or failure of such TOSHIBA products could cause loss of human life, bodily injury or damage to property. In developing your designs, please ensure that TOSHIBA products are used within specified operating ranges as set forth in the most recent TOSHIBA products specifications. Also, please keep in mind the precautions and conditions set forth in the "Handling Guide for Semiconductor Devices," or "TOSHIBA Semiconductor Reliability Handbook" etc..
- The TOSHIBA products listed in this document are intended for usage in general electronics applications (computer, personal equipment, office equipment, measuring equipment, industrial robotics, domestic appliances, etc.). These TOSHIBA products are neither intended nor warranted for usage in equipment that requires extraordinarily high quality and/or reliability or a malfunction or failure of which may cause loss of human life or bodily injury ("Unintended Usage"). Unintended Usage include atomic energy control instruments, airplane or spaceship instruments, transportation instruments, traffic signal instruments, combustion control instruments, medical instruments, all types of safety devices, etc.. Unintended Usage of TOSHIBA products listed in this document shall be made at the customer's own risk.
- The products described in this document are subject to the foreign exchange and foreign trade laws.
- The information contained herein is presented only as a guide for the applications of our products. No responsibility is assumed by TOSHIBA CORPORATION for any infringements of intellectual property or other rights of the third parties which may result from its use. No license is granted by implication or otherwise under any intellectual property or other rights of TOSHIBA CORPORATION or others.
- The information contained herein is subject to change without notice.

This datasheet has been download from:

www.datasheetcatalog.com

Datasheets for electronics components.