

SPEC No.	EL082049B
ISSUE: MAR 14 1997	

To: _____

REQUEST FOR
CONFIRMATION

SPECIFICATIONS

Product Type THE INTERFACE IC FOR TFT LCD PANEL

Model No. IR3Y26A

※This specifications contains 31 pages including the cover and appendix.
If you have any objections, please contact us before issuing purchasing order.

CUSTOMERS ACCEPTANCE

DATE: _____

BY: _____

PRESENTED

BY: T. Ohno
T. OHNO
Dept. General Manager

REVIEWED BY:

PREPARED BY:

H. Fujita

T. Matsui

Devices Engineering Dept.
Tenri Division
Tenri Integrated Circuits Group
SHARP CORPORATION

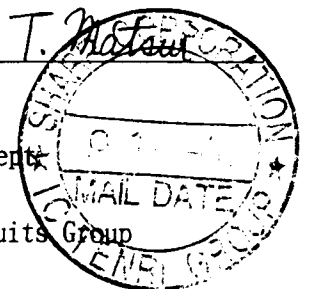

- Handle this document carefully for it contains material protected by international copyright law. Any reproduction, full or in part, of this material is prohibited without the express written permission of the company.

- When using the products covered herein, please observe the conditions written herein and the precautions outlined in the following paragraphs. In no event shall the company be liable for any damages resulting from failure to strictly adhere to these conditions and precautions.
 - (1) The products covered herein are designed and manufactured for the following application areas. When using the products covered herein for the equipment listed in Paragraph (2), even for the following application areas, be sure to observe the precautions given in Paragraph (2). Never use the products for the equipment listed in Paragraph (3).
 - Office electronics
 - Instrumentation and measuring equipment
 - Machine tools
 - Audiovisual equipment
 - Home appliances
 - Communication equipment other than for trunk lines

 - (2) Those contemplating using the products covered herein for the following equipment which demands high reliability, should first contact a sales representative of the company and then accept responsibility for incorporating into the design fail-safe operation, redundancy, and other appropriate measures for ensuring reliability and safety of the equipment and the overall system.
 - Control and safety devices for airplanes, trains, automobiles, and other transportation equipment
 - Mainframe computers
 - Traffic control systems
 - Gas leak detectors and automatic cutoff devices
 - Rescue and security equipment
 - Other safety devices and safety equipment, etc.

 - (3) Do not use the products covered herein for the following equipment which demands extremely high performance in terms of functionality, reliability, or accuracy.
 - Aerospace equipment
 - Communications equipment for trunk lines
 - Control equipment for the nuclear power industry
 - Medical equipment related to life support, etc.

 - (4) Please direct all queries and comments regarding the interpretation of the above three Paragraphs to a sales representative of the company.

- Please direct all queries regarding the products covered herein to a sales representative of the company.

CONTENTS

	Page
1. Description 2
2. Terminal Name 3
3. Terminal Connections (TOP VIEW) 4
4. Block Diagram 5
5. Description of terminals 6
6. Functional operation 10
7. Precautions 12
8. Absolute Maximum Ratings 13
9. Electrical Characteristics 14
10. Application Circuit Example 25
11. Package and Packing Specification 26

1. Description

The Sharp IR3Y26A is a multi-functional IC for a TFT LCD panel adopting the source drivers operating at 5V.

This IC contains polarity inverting circuits, common voltage generating circuit, and gamma correction circuits to meet the specific requirements of the LCD panels, and contains double channels of RGB inputs.

Applications:

LCD color television sets, LCD color displays, LCD color monitors etc..

Features:

- (1) Low power dissipation. (140mW TYP.)
- (2) Built-in double channels of RGB inputs.
- (3) Built-in gamma correction circuits.
- (4) Built-in polarity inverting circuits.
- (5) Built-in common voltage generating circuit.
- (6) Frequency characteristic 6.5MHz(TYP.)

* Not designed or rated as radiation hardened.

* Package material:

Plastic

* Chip material and wafer substrate type:

P type silicon

* Number of pins and package type:

48-pin quad-flat package

* Process (Structure):

Bipolar

2. Terminal Name

Pin No.	Terminal Name	Pin No.	Terminal Name
1	N. C.	25	N. C.
2	SYNC SEP	26	GAMMA 0
3	COM AMP	27	GAMMA 2
4	COM OUT	28	GND
5	CONTRAST	29	R OUT
6	B IN 1	30	R DCDET
7	GND	31	GND
8	G IN 1	32	G OUT
9	R IN 1	33	G DCDET
10	VCC1	34	VCC2
11	N. C.	35	B OUT
12	N. C.	36	N. C.
13	B IN 2	37	B DCDET
14	G IN 2	38	SUB BRIGHT B
15	R IN 2	39	SUB BRIGHT R
16	H FIL IN	40	RGB AMP
17	REG OUT	41	BRIGHT
18	SW	42	SUB CONTRAST B
19	H FIL OUT	43	SUB CONTRAST R
20	N. C.	44	N. C.
21	N. C.	45	COM FRP
22	N. C.	46	FRP
23	N. C.	47	SYNC IN
24	N. C.	48	SYNC OUT

3. Terminal Connections (TOP VIEW)

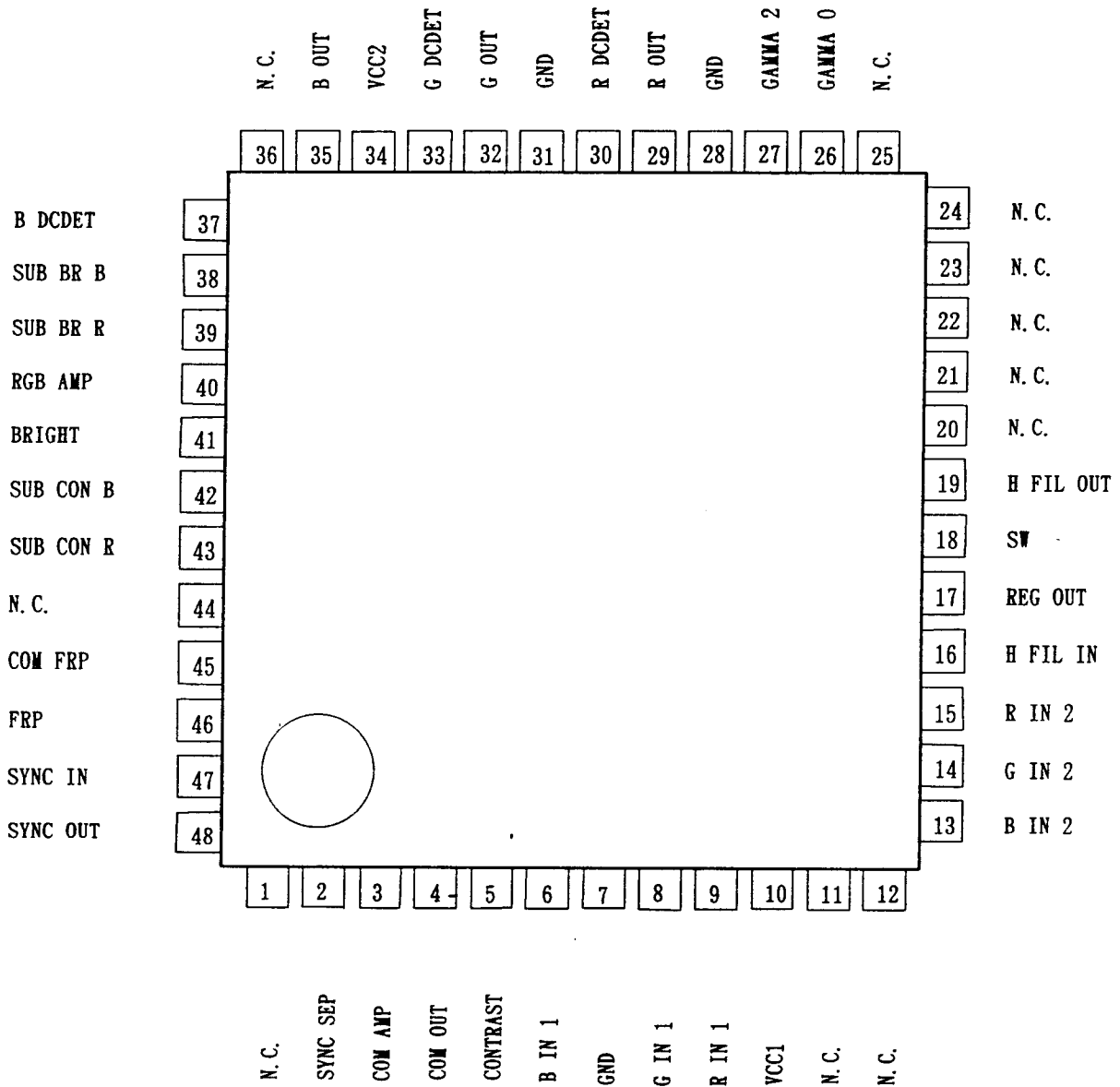

5. Description of Terminals ($V_{cc1}=5.0V$ These voltage are typical value.)

Pin No.	Term. Name	voltage	Equivalent circuit	Description
2	SYNC SEP	2.0V		The input terminal of the video signal or H FIL OUT signal for the SYNC-separation circuit.
3	COM AMP	2.1V		The DC voltage applied to this terminal adjusts the amplitude of the COM output. This terminal is preset inside the IC.
4	COM OUT			The output terminal of the COM signal.
5	CONTRAST	2.1V		The DC voltage applied to this terminal adjusts the contrast of the RGB output signals. This terminal is preset inside the IC.
6 8 9 13 14 15	B IN 1 G IN 1 R IN 1 B IN 2 G IN 2 R IN 2	1.9V		The input terminal of the analog RGB signals. These signals are required to be AC coupled.

Pin No.	Term. Name	voltage	Equivalent circuit	Description
7, 28 31	GND			These terminals are ground.
10	VCC1			Connect to the power supply
16	H FIL IN	2.0		The input terminal of the video signal for SYNC separation circuit. The impedance of this terminal is about a 12k Ω .
17	REG OUT	1.2V		The value of the resistor connected between this terminal and GND adjusts the width of the gate pulse.
18	SW			The input terminal for the source selection signal. Give the "Low" level in case of the RGB IN 2 inputs, and give the "High" level or open in case of the RGB IN 1 inputs.
19	H FIL OUT	4.0V		The output terminal of the video signal for SYNC-separation circuit.
26	GAMMA 0			The DC voltage applied to this terminal adjusts γ 0 point. This terminal is pre-set inside the IC.

pin No.	Term. Name	voltage	Equivalent circuit	Description
27	GAMMA 2	2.1V		<p>The DC voltage applied to this terminal adjusts the γ point.</p> <p>This terminal is pre-set inside the IC.</p>
29 32 35	R OUT G OUT B OUT	VCC1/2		<p>The output terminals of the RGB signals.</p> <p>The output circuits keep the DC voltage $V_{cc1}/2$.</p>
30 33 37	R DCDET G DCDET B DCDET			<p>These terminals are connected to the capacitors that smooth and hold the DC voltage of the RGB output signals.</p> <p>Because of the high impedance, use low leakage current capacitor.</p>
34	VCC2			<p>Connect to the power supply for the RGB outputs.</p>
38 39	SUB BRIGHT B SUB BRIGHT R	2.1V		<p>The DC voltage applied to these terminals adjust the brightness of the R and B signals finely by moving the gamma correction curve.</p> <p>These terminals are pre-set inside the IC.</p>
40	RGB AMP	2.1V		<p>The DC voltage applied to this terminal adjusts the amplitude (BLK-BLK) of the RGB output signals.</p> <p>This terminal is pre-set inside the IC.</p>

Pin No.	Term. Name	Voltage	Equivalent circuit	Description
4 1	BRIGHT			The DC voltage applied to this terminal adjusts the position of the gamma correction curve and the amplitude of the common output voltage.
4 2 4 3	SUB CON B SUB CON R	2.1V 2.1V		The DC voltage applied to these terminals finely adjust the contrast of the R and B signals. These terminals are pre-set inside the IC.
4 5	COM FRP			The input terminal for the switching signal of the COM output.
4 6	FRP			The input terminal for the inverting signal of the RGB outputs.
4 7	SYNC IN			The input terminal for the horizontal synchronizing pulse. (Active Low)
4 8	SYNC OUT	0.2V		The output terminal for the synchronizing pulse separated by the SYNC separation circuit. The output is provided by an open collector circuit.

6. Functional operation

• RGB Inputs

The RGB inputs accept the analog signals. When giving the "High" level to the SW input or opening it, the R IN 1, G IN 1 and B IN 1 are valid, and when giving the "Low" level to it, the R IN 2, G IN 2 and B IN 2 are valid.

• H FILTER

This consists of LPF and buffer for SYNC-separation circuit. The input impedance of the H FIL IN terminal is about a 12k Ω .

• Gamma correction

The output signals are corrected according to the characteristic of the LCD panel as shown in figure 1.

The pin 27 and 26 adjust the each relative position of the inflection γ_0 , γ_2 . The pin 32(bright) is able to adjust these positions at the same time.

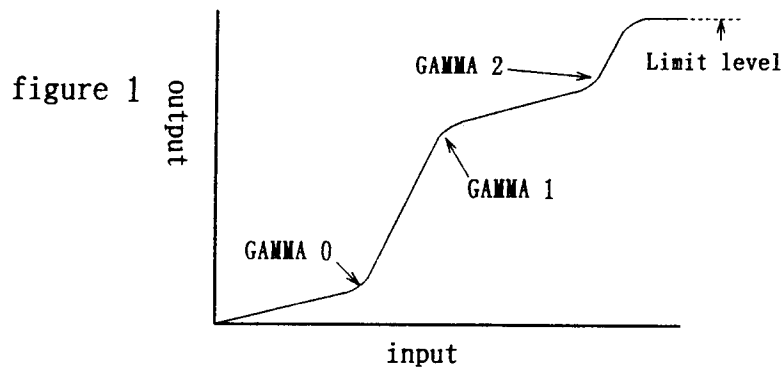

• RGB outputs

The RGB outputs (pin 29, pin 32, pin 35) are inverted by the FRP signal applied to the pin 46 as shown in Figure 2.

The output circuits keep the DC voltage $V_{cc1}/2$.

The dynamic range is adjusted by the RGB AMPLITUDE terminal(pin 40).

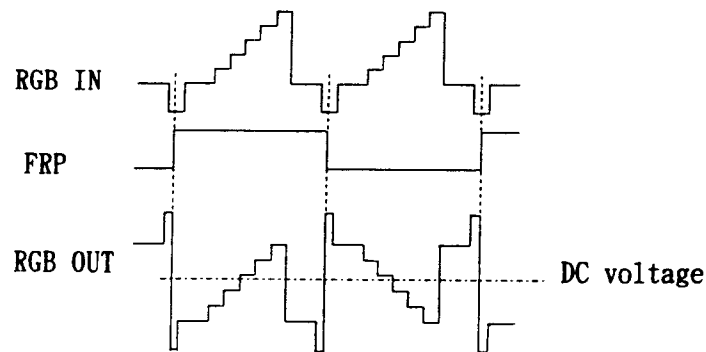

figure 2

• Bright control

The gamma correction points of the RGB output and the amplitude of the COM output change according to the voltage applied to the BRIGHT terminal. (Fig. 3) This circuit assumes that the COM output is amplitude threefold outside. The relation between the output amplitude and the gamma collection point is able to be adjusted according to the voltage applies to the COMMON AMPLITUDE ADJUST terminal.

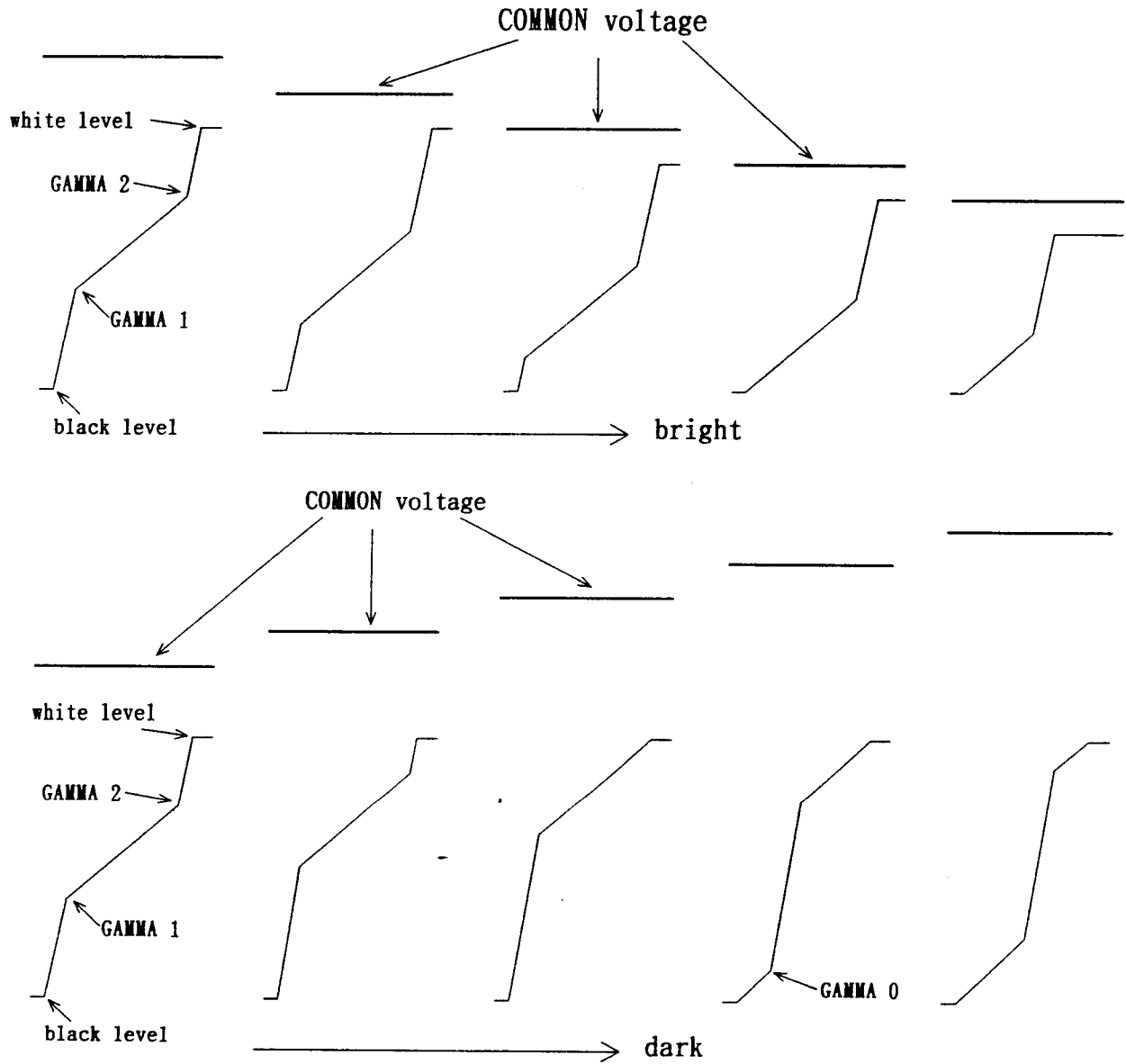

figure 3

7. Precautions

* Power supply pin

Ensure that pin 17 and pin 18 are at the lowest potential, and do not open them. Make sure that the voltage applied to the power supply pin must be as follows: $GND2 = GND1 \leq V_{cc1} \leq V_{cc2}$

* White-balance adjustment

The SUB BRIGHT B and R terminals (pin 30 and pin 31) are preset inside the IC. When these preset terminals are open, the white-balance could be lost by the deviation of the electronic components in the system. Therefore in some way, regulating the white-balance, is recommended.

* RGB outputs amplitude (between the black level and the following inverted black level)

Make the maximum amplitude of the RGB outputs below $V_{cc1} - 0.4V_{P-P}$. (including the case that adjusted by the SUB BRIGHT and the RGB AMPLITUDE ADJUST terminals)

* RGB outputs terminal and COMMON output terminal

In case of connecting low impedance loads, because the consumption current of the V_{cc2} terminal increase, pay attention to the maximum power dissipation of the package.

* Input of the signal

Synchronize all the input signals connected to the IC.

* Bright control limit

In case of varying the BRIGHT control voltage or GAMMA 0 control voltage, make the gamma 0 position be below 1V above the pedestal level.

* Common Amplitude Adjust

It is recommended not to supply COMMON AMPLITUDE ADJUST with a constant voltage but to adjust it one by one. The output amplitude of COMMON OUT has a variability of $1.55 \pm 0.3V_{P-P}$ when COMMON AMPLITUDE ADJUST is supplied with a voltage of 2.05V and BRIGHT is supplied with a voltage of 1.0V.

It is afraid that the variability of luminance on the LCD display should increase at a constant COMMON AMPLITUDE ADJUST voltage, because both the output amplitude and the variability of COMMON OUT are amplitude, and a LCD module is supplied with them.

* Output dynamic range

Adjust RGB AMP (pin 40) to make the output dynamic range more than $3V_{P-P}$.

8. Absolute Maximum Ratings (Ta=25°C)

Parameter	Symbol	Conditions	Rating	Units
Supply voltage	V _{CC1} - GND		7	V
	V _{CC2} - GND		10	V
Power dissipation	P _D	T _a ≤ 25°C	580	mW
Derating ratio		T _a > 25°C	4.64	mW/°C
Operating temperature range	T _{opr}		-30 ~ 85	°C
Storage temperature range	T _{stg}		-55 ~ 150	°C
Each adjust pins voltage	V _{IN}		GND ~V _{CC1}	V
SYNC OUT output strength voltage	V _{SD}		10	V
RGB input signals voltage			V _{CC1} *1	V
FRP input signal voltage			GND ~V _{CC1}	V
SYNC IN input signal voltage			GND ~V _{CC1}	V

*1) Means the potentials of pin 6, 8, 9, 13, 14 and 15 are in this range.

Operating supply voltage range

Parameter	Symbol	Conditions	Rating	Units
Operating supply voltage range	V _{CC1} -GND		4.5~5.5	V
	V _{CC2} -GND		7.0~8.0	V
	V _{CC2} -V _{CC1}		≥2.0	V

Recommended operating conditions

Parameter	Symbol	Conditions	Rating			Units
			MIN	TYP	MAX	
RGB analog input signals voltage	vRGB _{IN}		0	0.714	0.8	V _{P-P} *2
H FIL IN input signals voltage	vHF _{IN}			1.0		V _{P-P}
FRP input "HI" level voltage			2.0			V
FRP input "LOW" level voltage					0.8	V
COM FRP input "HI" level voltage			2.0			V
COM FRP input "LOW" level voltage					0.8	V
SYNC IN input "HI" level voltage			2.0			V
SYNC IN input "LOW" level voltage					0.8	V

*2 Between the pedestal level and the white level.

9. Electrical Characteristics

Unless otherwise $V_{cc1}=5.0V$, $V_{cc2}=7.5V$, $T_a=25^\circ C$, SW2→a, SW3→OFF, SW5→ON, SW26→OFF, SW27→OFF, SW29→OFF, SW32→OFF, SW35→OFF, SW38→OFF, SW39→OFF, SW40→OFF, SW42→OFF, SW43→OFF
 $V_5=2.1V$, $V_{41}=1.7V$, $V_{18}=5.0V$,
 (B1), (G1), (R1), (B2), (G2), (R2) and (A)=GND, SG2 applied to TP45 and TP46
 SG1(5Vp-p) applied to TP47.

No.	Parameter	symbol	Conditions	MIN	TYP	MAX	Units
1	Current dissipation	I_{cc1}			13.0	20.0	mA
2	Current dissipation	I_{cc2}			10.0	18.0	mA
3	SYNC SEP terminal voltage	V2	SW2→b	1.6	1.9	2.4	V
4	COM AMP terminal voltage	V3		1.7	2.1	2.5	V
5	CONTRAST terminal voltage	V5	SW5→OFF	1.7	2.1	2.5	V
6	B IN1 terminal voltage	V6		1.6	1.9	2.4	V
7	G IN1 terminal voltage	V8		1.6	1.9	2.4	V
8	R IN1 terminal voltage	V9		1.6	1.9	2.4	V
9	B IN2 terminal voltage	V13		1.6	1.9	2.4	V
10	G IN2 terminal voltage	V14		1.6	1.9	2.4	V
11	R IN2 terminal voltage	V15		1.6	1.9	2.4	V
12	H FIL IN terminal voltage	V16		1.6	2.0	2.4	V
13	REG OUT terminal voltage	V17		1.0	1.2	1.5	V
14	H FIL OUT terminal voltage	V19		3.2	4.0	4.6	V
15	GAMMA 0 terminal voltage	V26		1.7	2.1	2.5	V
16	GAMMA 2 terminal voltage	V27		1.7	2.1	2.5	V
17	SUB BR B terminal voltage	V38		1.7	2.1	2.5	V
18	SUB BR R terminal voltage	V39		1.7	2.1	2.5	V
19	RGB AMP terminal voltage	V40		1.7	2.1	2.5	V
20	SUB CON B terminal voltage	V42		1.7	2.1	2.5	V
21	SUB CON R terminal voltage	V43		1.7	2.1	2.5	V
22	SYNC SEP input current	I2	SW2→b, TP2=3.0V	9.0	14.0	19.0	μA
23	B IN1 input current	I6	TP47=5V, TP6=2.0 V	-0.1	0	0.1	μA
24	G IN1 input current	I8	TP47=5V, TP8=2.0 V	-0.1	0	0.1	μA
25	R IN1 input current	I9	TP47=5V, TP9=2.0 V	-0.1	0	0.1	μA
26	B IN2 input current	I13	TP47=5V, TP13=2.0 V	-0.1	0	0.1	μA
27	G IN2 input current	I14	TP47=5V, TP14=2.0 V	-0.1	0	0.1	μA
28	R IN2 input current	I15	TP47=5V, TP15=2.0 V	-0.1	0	0.1	μA
29	SW"L" input current	IL18	V18=0V		-0.5	-4.5	μA
30	SW"H" input current	IH18	V18=5V	-0.1	0	0.1	μA
31	BRIGHT input current	I41	V41=0V		-0.5	-4.5	μA
32	COM FRP"L" input current	IL45	V45=0V		-0.5	-4.5	μA
33	COM FRP"H" input current	IH45	V45=5V	-0.1	0	0.1	μA
34	FRP"L" input current	IL46	V46=0V		-0.5	-4.5	μA
35	FRP"H" input current	IH46	V46=5V	-0.1	0	0.1	μA
36	SYNC IN"L" input current	IL47	V47=0V		-0.5	-4.5	μA
37	SYNC IN"H" input current	IH47	V47=5V	-0.1	0	0.1	μA
38	COM AMP input impedance	Z3		35	60	100	k Ω
39	CONTRAST input impedance	Z5		13	20	40	k Ω
40	H FIL IN input impedance	Z16		8	12	18	k Ω
41	GAMMA 0 input impedance	Z26		35	60	100	k Ω

No.	Parameter	symbol	Conditions	MIN	TYP	MAX	Units
42	GAMMA 2 input impedance	Z27		35	60	100	k Ω
43	SUB BR B input impedance	Z38		35	60	100	k Ω
44	SUB BR R input impedance	Z39		35	60	100	k Ω
45	RGB AMP input impedance	Z40		35	60	100	k Ω
46	SUB CON B input impedance	Z42		35	60	100	k Ω
47	SUB CON R input impedance	Z43		35	60	100	k Ω

No.	Parameter	symbol	Conditions	MIN	TYP	MAX	units
48	Maximum gain	G_{MAX}	With SW26-ON, V5=3.3V, V18=5.0V, V26=3.5V, V41=1.7V and SG3 applied to B1, G1, R1, B2, G2, R2, adjust the amplitude of SG3(V_{IM}) for making the amplitude (BLK-WHT) of the non-invert signal on TP32 2Vp-p. Then, define the non-invert side of the amplitudes(BLK-WHT) on TP29, TP32 and TP35 as V_{ROM1} , V_{GOM1} and V_{BOM1} . Similarly with V18=0V, as V_{ROM2} , V_{GOM2} and V_{BOM2} . $G_{MAX}=20\text{LOG}(V_{ROM1}/V_{IM}), 20\text{LOG}(V_{ROM2}/V_{IM}), 20\text{LOG}(V_{GOM1}/V_{IM}), 20\text{LOG}(V_{GOM2}/V_{IM}), 20\text{LOG}(V_{BOM1}/V_{IM}), 20\text{LOG}(V_{BOM2}/V_{IM})$.	22	25	28	dB
49	Contrast variable range	ΔG_C	With SW26-ON, V5=1.0V, V18=5.0V, V26=3.5V, V41=1.7V and SG3(amplitude: V_{IM}) applied to B1, G1, R1, B2, G2, R2. Then, define the non-invert side of the amplitudes(BLK-WHT) on TP29, TP32 and TP35 as V_{RON1} , V_{GON1} and V_{BON1} . Similarly with V18=0V, the non-invert side as V_{RON2} , V_{GON2} and V_{BON2} . $\Delta G_C=20\text{LOG}(V_{ROM1}/V_{RON1}), 20\text{LOG}(V_{ROM2}/V_{RON2}), 20\text{LOG}(V_{GOM1}/V_{GON1}), 20\text{LOG}(V_{GOM2}/V_{GON2}), 20\text{LOG}(V_{BOM1}/V_{BON1}), 20\text{LOG}(V_{BOM2}/V_{BON2})$.	7	9	11	dB
50	Gain difference among inputs	ΔG_I	With SW26-ON, V5=2.1V, V18=5.0V, V26=3.5V, V41=1.7V and SG3(amplitude: V_{IM}) applied to B1, G1, R1, B2, G2, R2. Then, define the non-invert side of the amplitudes(BLK-WHT) on TP29, TP32 and TP35 as V_{ROT1} , V_{GOT1} and V_{BOT1} , the invert side of them as V_{ROT1A} , V_{GOT1A} and V_{BOT1A} . Similarly with V18=0V, non-invert side as V_{ROT2} , V_{GOT2} , V_{BOT2} and invert side as V_{ROT2A} , V_{GOT2A} , V_{BOT2A} . $\Delta G_I=20\text{LOG}(V_{ROT2}/V_{ROT1}), 20\text{LOG}(V_{GOT2}/V_{GOT1}), 20\text{LOG}(V_{BOT2}/V_{BOT1})$.			± 0.7	dB
51	Gain difference among RGB	ΔG_O	$\Delta G_O=20\text{LOG}(V_{GOT1}/V_{ROT1}), 20\text{LOG}(V_{BOT1}/V_{GOT1}), 20\text{LOG}(V_{ROT1}/V_{BOT1}), 20\text{LOG}(V_{GOT2}/V_{ROT2}), 20\text{LOG}(V_{BOT2}/V_{GOT2}), 20\text{LOG}(V_{ROT2}/V_{BOT2})$			± 0.8	dB
52	Gain difference between invert and non-invert	ΔG_{INV}	$\Delta G_{INV}=20\text{LOG}(V_{ROT1A}/V_{ROT1}), 20\text{LOG}(V_{ROT2A}/V_{ROT2}), 20\text{LOG}(V_{GOT1A}/V_{GOT1}), 20\text{LOG}(V_{GOT2A}/V_{GOT2}), 20\text{LOG}(V_{BOT1A}/V_{BOT1}), 20\text{LOG}(V_{BOT2A}/V_{BOT2})$			± 0.7	dB
53	Sub-Contrast variable range	ΔG_{SC}	With SW26-ON, V5=2.1V, V26=3.5V, V41=1.7V, and SG3 applied to B1, G1, R1, adjust the amplitude of SG3 for making the amplitude (BLK-WHT) of non-invert signal on TP32 2V. Then, with SW42-ON, SW43-ON, V42=1.0V, V43=1.0V, define the non-invert side of the amplitudes(BLK-WHT) on TP29 and TP35 as V_{ROS1} , V_{BOS1} . Similarly with V42=3.0V and V43=3.0V, non-invert side as V_{ROB1} and V_{BOB1} .	± 2	± 3		dB

No.	Parameter	symbol	Conditions	MIN	TYP	MAX	units
			$\Delta G_{SC} =$ $20\text{LOG}(V_{ROS1}/V_{ROT1}), 20\text{LOG}(V_{BOS1}/V_{BOT1}),$ $20\text{LOG}(V_{ROB1}/V_{ROT1}), 20\text{LOG}(V_{BOB1}/V_{BOT1}).$				
54	RGB outputs maximum amplitude	V_{BM}	With V40=1.7V, SW40-ON, measure the amplitudes(BLK-BLK) of TP29, TP32 and TP35.	4.0	4.5		V _{p-p}
55	RGB outputs black level voltage difference	ΔV_B	Define the non-invert black levels on TP29, TP32 and TP35 as V_{RB}, V_{GB} and V_{BB} . The invert black levels as $V_{RBA}, V_{GBA}, V_{BBA}$. $\Delta V_B = V_{RB} - V_{GB}, V_{GB} - V_{BB}, V_{BB} - V_{RB}$ $V_{RBA} - V_{GBA}, V_{GBA} - V_{BBA}, V_{BBA} - V_{RBA}$			±200	mV
56	Sub-brightness adjust variable range	ΔV_{BS}	With SW26-ON, V26=3.5V, V41=1.7V and SG3 applied to B1, G1, R1, adjust the amplitude of SG3 for making the amplitude(BLK-WHT) of the non-invert signal on TP32 2V. Then, define the non-invert side of second stage(a ₂ -GND) amplitudes on TP29 and TP35 as V_{R2T} and V_{B2T} . Similarly, invert side as V_{R2TA} and V_{B2TA} . with SW38-ON, SW39-ON, V38=1.0V, V39=1.0V, similarly as $V_{R2M}, V_{B2M}, V_{R2MA}$ and V_{B2MA} . With V38=3.2V, V39=3.2V, similarly as $V_{R2N}, V_{B2N}, V_{R2NA}$ and V_{B2NA} . $\Delta V_{BS} = V_{R2T} - V_{R2M}, V_{R2TA} - V_{R2MA}, V_{B2T} - V_{B2M},$ $V_{B2TA} - V_{B2MA}, V_{R2T} - V_{R2N}, V_{R2TA} - V_{R2NA},$ $V_{B2T} - V_{B2N}, V_{B2TA} - V_{B2NA}.$	±0.25	±0.50		V
57	Peak limit characteristics	V_P	With V41=2.5V, SG3 applied to B1, G1, R1. Measure the amplitudes(BLK-WHT) of non-invert signals on TP29, TP32 and TP35.	1.4	1.8	2.2	V
58	RGB outs DC voltage	V_C	Measure the average voltages of TP29, TP32 and TP35.	2.30	2.50	2.70	V
59	Frequency characteristic	f_c	With SW26-ON, SW29-ON, SW32-ON, SW35-ON, V26=3.5V, V41=1.7V and SG5(f=100kHz) applied to R1, G1, B1, adjust the amplitude of SG5 for making the amplitude of sine wave part of the non-invert signal on TP32 2V. Increase the frequency on TP29, TP32 and TP35 until attenuate by 3dB from the amplitude at the 100kHz.	5.0	6.5		MHz
60	Crosstalk among RGB	CT_{RGB}	With SW26-ON, V26=3.5V, V41=1.7V, TP46=0V, and SG5(f=1MHz) applied to G1. Adjust the amplitude of SG5(V_i) for making the amplitude of sine wave part of the non-invert signal on TP32 2V. Measure the amplitudes of 1MHz component on TP29, TP32 and TP35. Calculate the amplitude ratios of TP29 and TP35 to TP32. Similarly, with SG5 (f=1MHz, amplitude= v_i) applied to B1, measure the ratios of TP29 and TP32 to TP35. Similarly, with SG5(f=1MHz, amplitude= v_i) applied to R1, measure the ratios of TP32 and TP35 to TP29.	40	50		dB

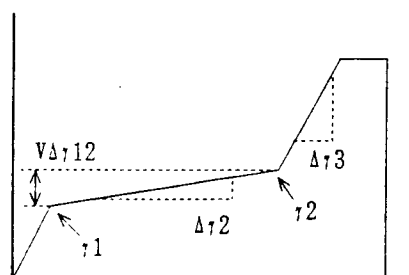
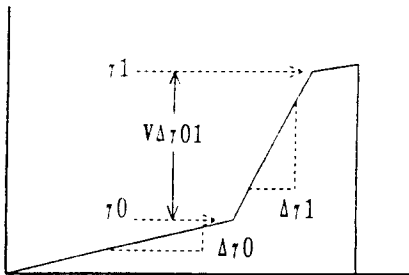
No.	Parameter	symbol	Conditions	MIN	TYP	MAX	units
61	Crosstalk between RGB inputs (IN1→IN2)	CT ₁₂	With SW26-ON, V26=3.5V, V41=1.7V, TP46=0V, V18=5V and SG5(f=1MHz, amplitude=v ₁) applied to B1, measure the amplitude of 1MHz component on TP35. Then with V18=0V, measure the attenuation of 1MHz component on TP35. Similarly, to G1 and R1, measure one on TP32 and TP35.	40	50		dB
62	Crosstalk between RGB inputs	CT ₂₁	With SW26-ON, V26=3.5V, V41=1.7V, TP46=0V, V18=0V and SG5(f=1MHz, amplitude=v ₁) applied to B2. measure the amplitude of 1MHz component on TP35. Then with V18=5V, measure the attenuation of 1MHz component on TP35. Similarly, to G2 and R2, measure one on TP32 and TP35.	40	50		dB
63	COM OUT maximum amplitude	V _{VM}	With V3=3.0V, V41=1.0V, measure the amplitude on TP4.	5.0	5.4		V _{p-p}
64	COM OUT amplitude	DVCOM	With SW3-ON, V3=2.05V, V41=2.0V, measure the amplitude on TP4.	1.25	1.55	1.85	V _{p-p}
65	COM OUT amplitude adjustable range (1)	ΔV _{C1}	With V3=1.0V, V41=1.0V, measure the amplitude on TP4, define it as V _{CN} . ΔV _{C1} =V _{CM} -V _{CN} (In case of the contrary phase, define ΔV _{C1} as follows: ΔV _{C1} =V _{CM} +V _{CN} .)	7.5	8.2	9.0	V
66	COM OUT amplitude adjustable range (2)	ΔV _{C2}	With V3=1.0V, V41=2.4V, measure the amplitude on TP4, define it as V _{CT} . ΔV _{C2} =V _{CM} -V _{CT} (In case of the contrary phase, define ΔV _{C1} as follows: ΔV _{C1} =V _{CM} +V _{CT} .)	9.5	10.8		V
67	RGB outputs amplitude adjustable range	ΔV _{RGB}	With SW40-ON, measure the differences of the amplitudes(BLK-BLK) on TP29, TP32 and TP35, between V40=1.7V and V40=3.2V.	1.5	2.2		V
68	Gamma characteristic(1)	Δ _{γ3}	With V41=2.05V and SG4 applied to B1, G1 and R1, measure the slopes on TP29, TP32 and TP35.		220		mV/ μs
69	Gamma characteristic(2)	Δ _{γ2}			50		mV/ μs
70	Gamma characteristic(3)	Δ _{γ1}			220		mV/ μs
71	Gamma characteristic(4)	Δ _{γ0}		Similarly with V41=1.60V, measure the slopes on TP29, TP32 and TP35.		50	
72	Gamma characteristic(5)	V _{Δγ01}			2.0		V
73	Gamma characteristic(6)	V _{Δγ12}				1.5	

No.	Parameter	symbol	Conditions	MIN	TYP	MAX	units
74	Common-Gamma tracking ratio	R_T	With SW26→ON, SW27→ON, V3=2.2V, V26=3.5V, V27=3.0V and SG3(0dB) applied to B1, G1, R1, changing V41=1.9V to 2.3V define the change of the amplitude between the BLACK level and the 7th state level(a0-a7) of the non-invert signals on TP29, TP32, TP35 as ΔV_B . Define the change of the amplitude on TP4 as ΔV_C . $R_T = (2\Delta V_B / \Delta V_C) * (\Delta \gamma_1 / (\Delta \gamma_1 - \Delta \gamma_2))$ Use the result of No. 68 and No. 69 for $\Delta \gamma_1$ and $\Delta \gamma_2$.	2.5	3.0	3.5	
75	SW pin "HI" level input voltage	V_{HSW}		2.0			V
76	SW pin "LOW" level input voltage	V_{LSW}				0.8	V
77	COM FRP pin "HI" level input voltage	V_{HCF}		2.0			V
78	COM FRP pin "LOW" level input voltage	V_{LCF}				0.8	V
79	FRP pin "HI" level input voltage	V_{HF}		2.0			V
80	FRP pin "LOW" level input voltage	V_{LF}				0.8	V
81	SYNC IN pin "HI" level input voltage	V_{HS}		2.0			V
82	SYNC IN pin "LOW" level input voltage	V_{LS}				0.8	V
83	Sync separator in. sensitivity current	I_{is}	With SW2→b, measure the input current on TP2 that causes TP48 to change from "L" to "H".		21	30	μA
84	Sync sep. output ON-state voltage	V_{ON}	Measure the voltage on TP48		0.2	0.5	V
85	sync sep. output OFF-state leakage current	I_{SL}	With SW2→b and TP48=10V, drawing the $40\mu A$ current from TP2, measure the current from TP48 to pin 48.			1.0	μA
86	H FIL OUT gain	G_{hf}	With SG1(0.286V _{p-p}) applied to (A), measure the voltage on TP19 for v_{hf} . $G_{hf} = 20\text{LOG}(v_{hf} / 0.286)$	1.0	2.3		dB
87	Sync separator output propagation delay time	t_{PHL} (SY)	With SG1(0.286V _{p-p}) applied to (A), measure the propagation delay time.		0.6		μS
		t_{PLH} (SY)			1.0		μS
88	Sync separator output fall time output rise time	t_{fHL} (SY)	With SG1(0.286V _{p-p}) applied to (A), measure the fall time and the rise time on TP48		0.2		μS
		t_{rLH} (SY)			0.5		μS

No.	Parameter	symbol	Conditions	MIN	TYP	MAX	units
89	RGB outputs propagation delay time	t_{PHL} (RGB)	With SW26→ON, V18=5V, V26=3.5V, V41=1.7V, and SG6 applied to G1, adjust the amplitude of SG6 for making the amplitude (BLK-WHT) of the non-invert signal on TP21 2V, define it as v_i .		0.1		μ S
		t_{PLH} (RGB)			0.1		μ S
90	RGB outputs fall time rise time	t_{LHL} (RGB)	Measure the delay time from G1 to TP32, and the fall time and rise time on TP32. Similarly, measure the delay time from B1 and R1 to TP29 and TP35 and the fall time and the rise time on TP29 and TP35. Similarly with V18=0V, measure delay time, fall time and rise time from B2, G2 and R2 to TP29, TP32 and TP35.		0.2		μ S
		t_{LLH} (RGB)			0.2		μ S
91	FRP square wave propagation delay	t_{PHL} (FRP)	Measure the propagation delay times from TP46 to TP29, TP32 and TP35.		0.1		μ S
		t_{PLH} (FRP)			0.1		μ S
92	FRP square wave rise time fall time	t_{LHL} (FRP)	Measure the fall times and rise times of output signals on TP29, TP32 and TP35.		0.1		μ S
		t_{LLH} (FRP)			0.1		μ S
93	COM output propagation	t_{PHL} (COM)	Measure the propagation delay time from TP45 to TP4.		0.1		μ S
		t_{PLH} (COM)			0.1		μ S
94	COM output rise time fall time	t_{tHL} (COM)	Measure the rise time and fall time of TP4.		0.1		μ S
		t_{tLH} (COM)			0.1		μ S
95	SW propagation delay time	t_{PHL} (SW)	With SW26→ON, V18=5V, V26=3.5V, V41=1.7V, SG6 applied to B1, G1, R1, adjust the amplitude of SG6 for making the amplitude (BLK-WHT) of the non-invert signal on TP32 2V. Then with SG7 applied to TP8. observe the waveform on SG7, TP29, TP32 and TP35.		0.1		μ S
		t_{PLH} (SW)			0.1		μ S
96	SW rise time fall time	t_{LHL} (SW)	TP32 2V. Then with SG7 applied to TP8. observe the waveform on SG7, TP29, TP32 and TP35.		0.1		μ S
		t_{LLH} (SW)			0.1		μ S

No.	signal name	waveform
SG1	sync signal	<p>variable amplitude 0V 5µs 64µs tr, tf < 50ns</p>
SG2	FRP square wave	<p>tr, tf < 50ns 5V 0V 2.5µs SG1</p>
SG3	Variable APL 10stage atair wave signal	<p>0 dB waveform a10 a9 a8 a7 a6 a5 a4 a3 a2 a1 a0 0.714V 0.286V 5µs 64µs</p>
SG4	ramp waveform	<p>0.714V 0.286V 5µs 14µs 36µs 7µs 64µs</p>

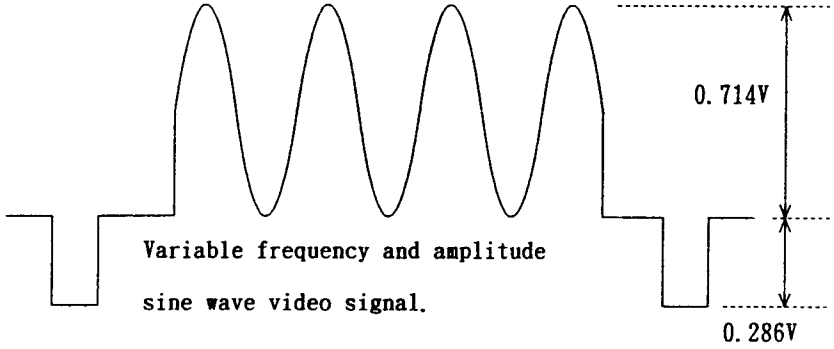
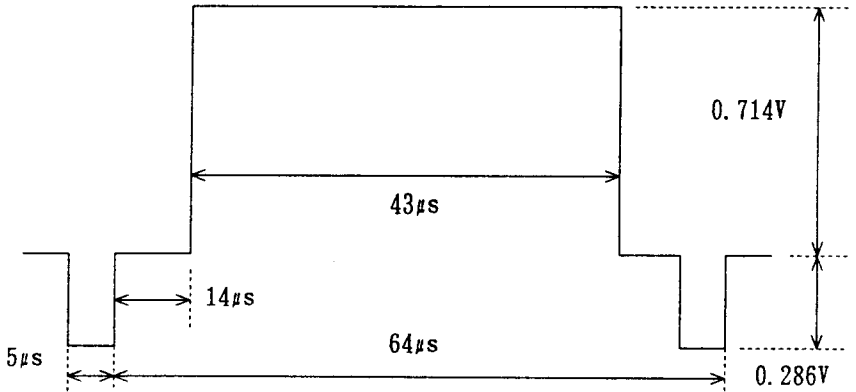
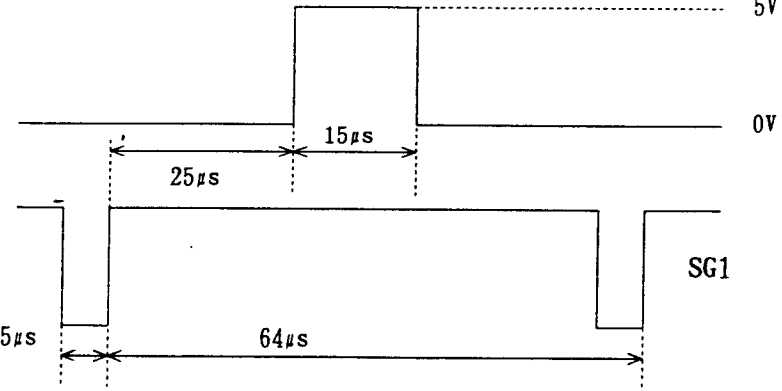
No.	signal name	waveform
SG5	Sine wave	 <p>Variable frequency and amplitude sine wave video signal.</p>
SG6	Complete white video signal	
SG7	SW signal	<p>Synchronised with SG1 pulse</p> 

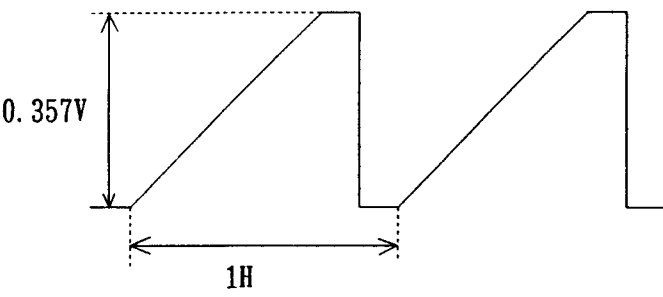
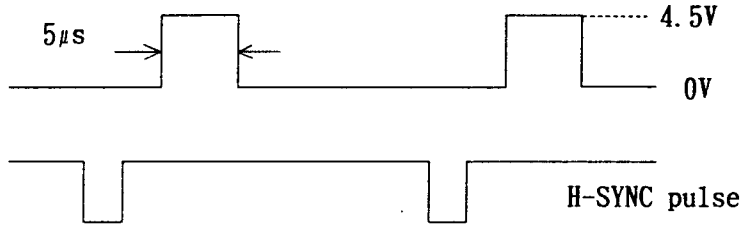
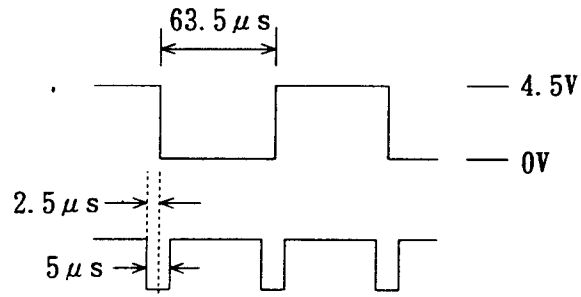
SG No.	waveform
SG 9	 <p>0.357V</p> <p>1H</p>
SG 10	<p>tr, tf < 50ns</p>  <p>5µs</p> <p>4.5V</p> <p>0V</p> <p>H-SYNC pulse</p> <p>Synchronised with H-SYNC pulse</p>
SG 11	<p>FRP square wave tr, tf < 50ns</p>  <p>63.5µs</p> <p>4.5V</p> <p>0V</p> <p>2.5µs</p> <p>5µs</p> <p>H-SYNC pulse</p>

Test Circuit

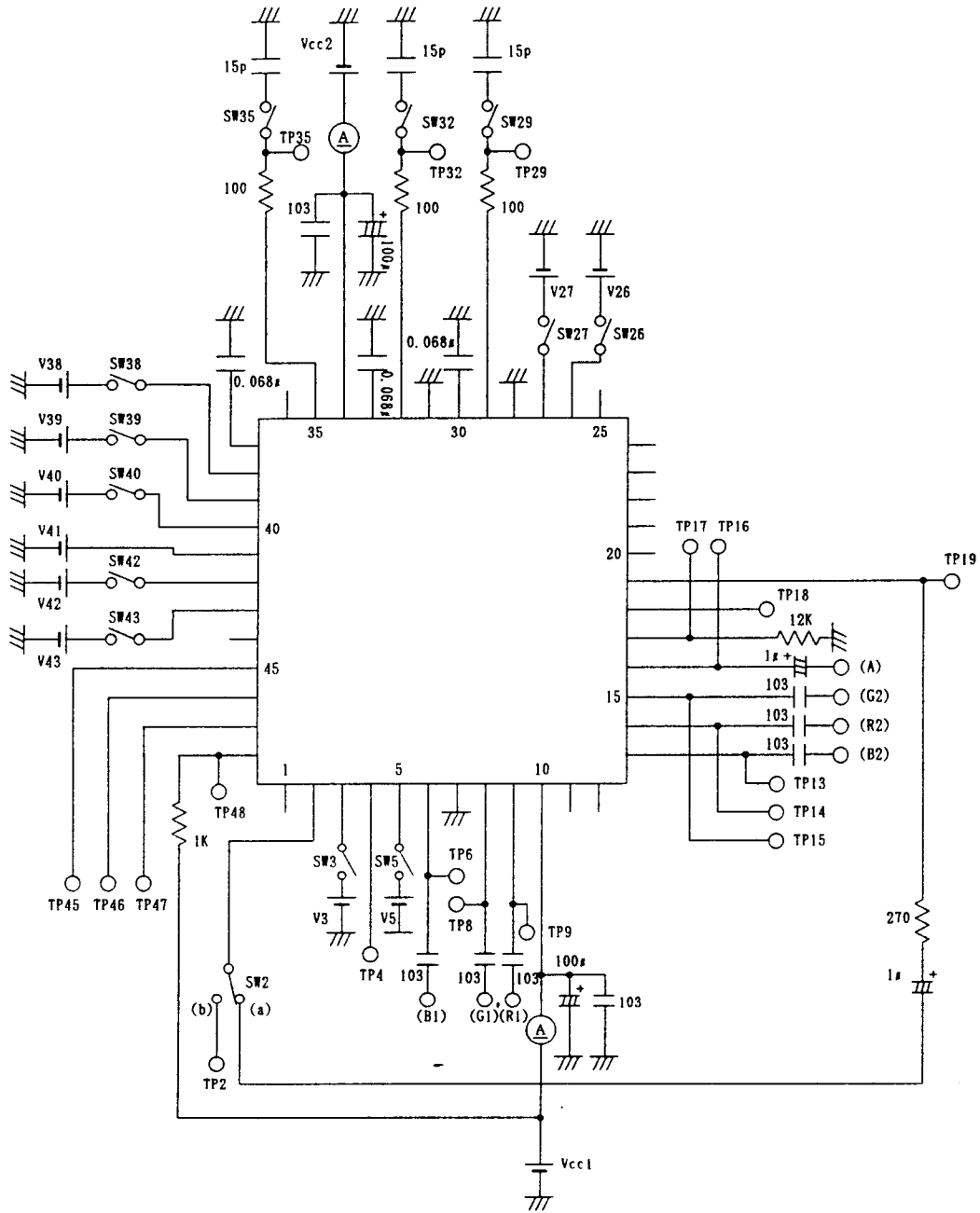

10. Application circuit example

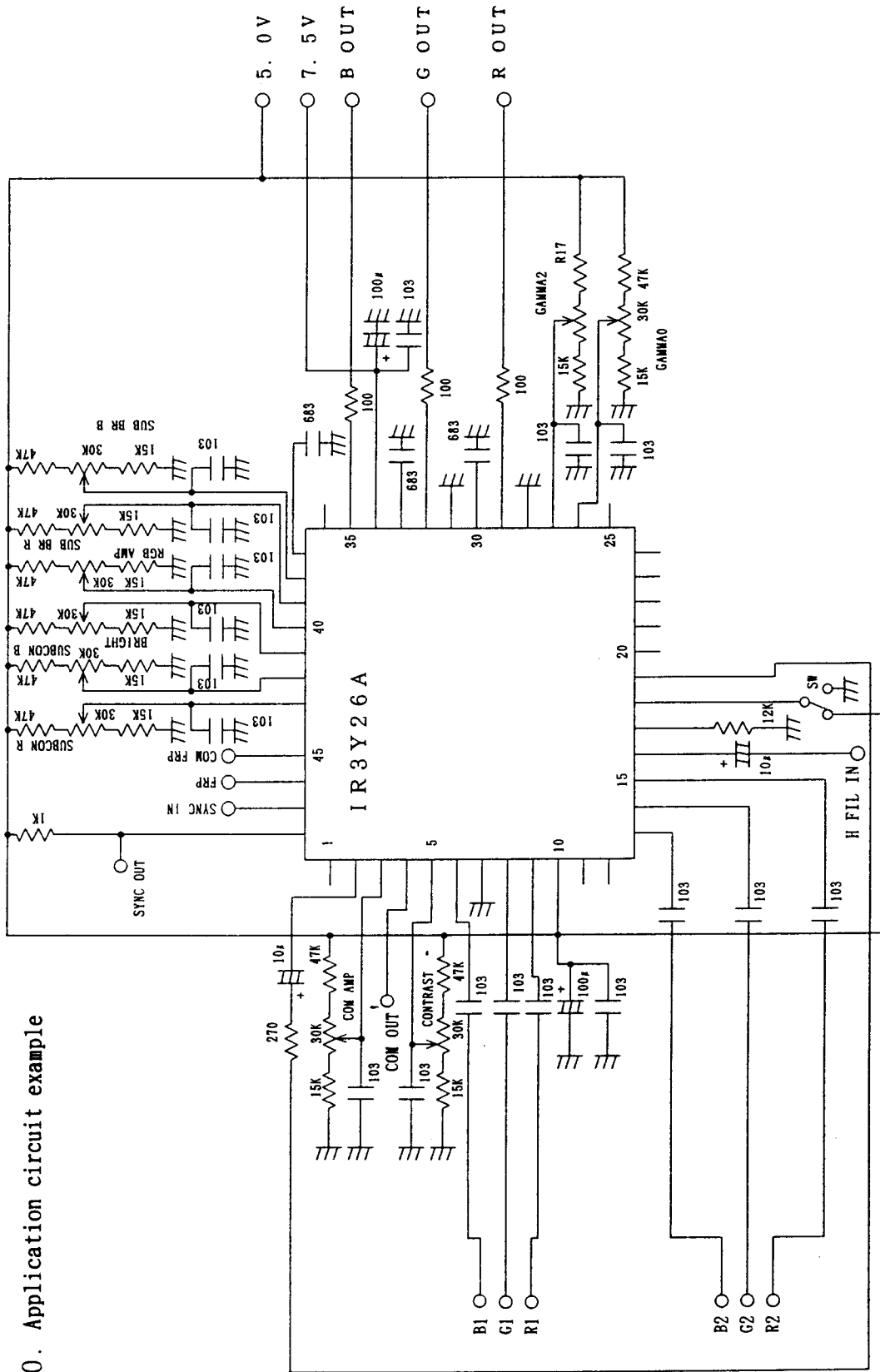

11 Package and packing specification

1. Package Outline Specification

Refer to drawing No. AA 8 7 3

2. Markings

2-1. Marking contents

(1) Product name : IR3Y26A

(2) Company name : SHARP

(3) Date code

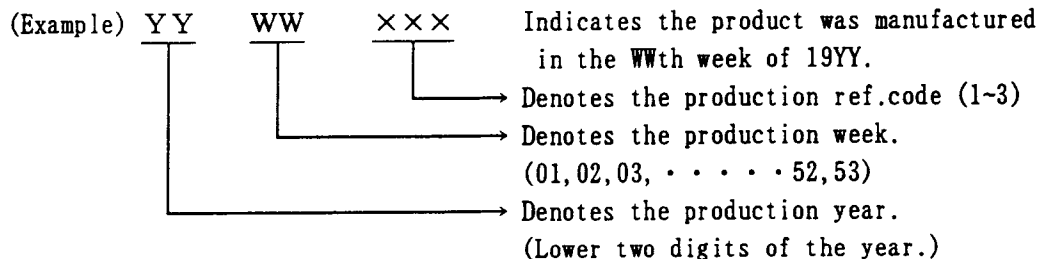

(4) The marking of "JAPAN" indicates the country of origin.

2-2. Marking layout

Refer to drawing No. AA 8 7 3

(This layout do not define the dimensions of marking character and marking position.)

3. Packing Specification

3-1. Packing materials

Material Name	Material Specification	Purpose
Tray	Conductive plastic (80devices/tray)	Fixing of device
Upper cover tray	Conductive plastic (1tray/case)	Fixing of device
Laminated aluminum bag	Aluminum polyethylene (1bag/case)	Drying of device
Desiccant	Silica gel	Drying of device
P P band	Polypropylene (3pcs)	Device tray fixing
Inner case	Card board (800devices/case)	Packaging of device
Label	Paper	Indicates part number, quantity and date of manufacture
Outer case	Cardboard	Outer packing of device case

(Devices shall be placed into a tray in the same direction.)

3-2. Outline dimension of tray

Refer to attached drawing

4. Precaution For Unpacking

(1) Unpacking should be done on the stand as well as human body treated with anti-ESD.

(2) Conductive treatment or anti-ESD treatment is given to a dray. Use the equivalent tray, if it is changed to another one.

5. Surface Mount Conditions

Please perform the following conditions when mounting ICs not to deteriorate IC quality.

5-1. Soldering conditions (The following conditions are valid only for one time soldering.)

Mounting Method	Temperature and Duration	Measurement Point
Reflow soldering (air)	Peak temperature of 240°C, duration less than 15 seconds above 230°C, temperature increase rate of 1~4°C/second	IC surface
Solder dipping	245°C or less, duration less than 3 seconds/dip, total of 5 seconds	Solder bath
Vapor phase solderring	215°C or less, duration less than 40 seconds above 200°C	Steam
Manual soldering (soldering iron)	260°C or less, duration less than 10 seconds	IC outer lead surface

5-2. Conditions for removal of residual flux

- (1) Ultrasonic washing power : 25 Watts/liter or less
- (2) Washing time : Total 1 minute maximum
- (3) Solvent temperature : 15~40°C

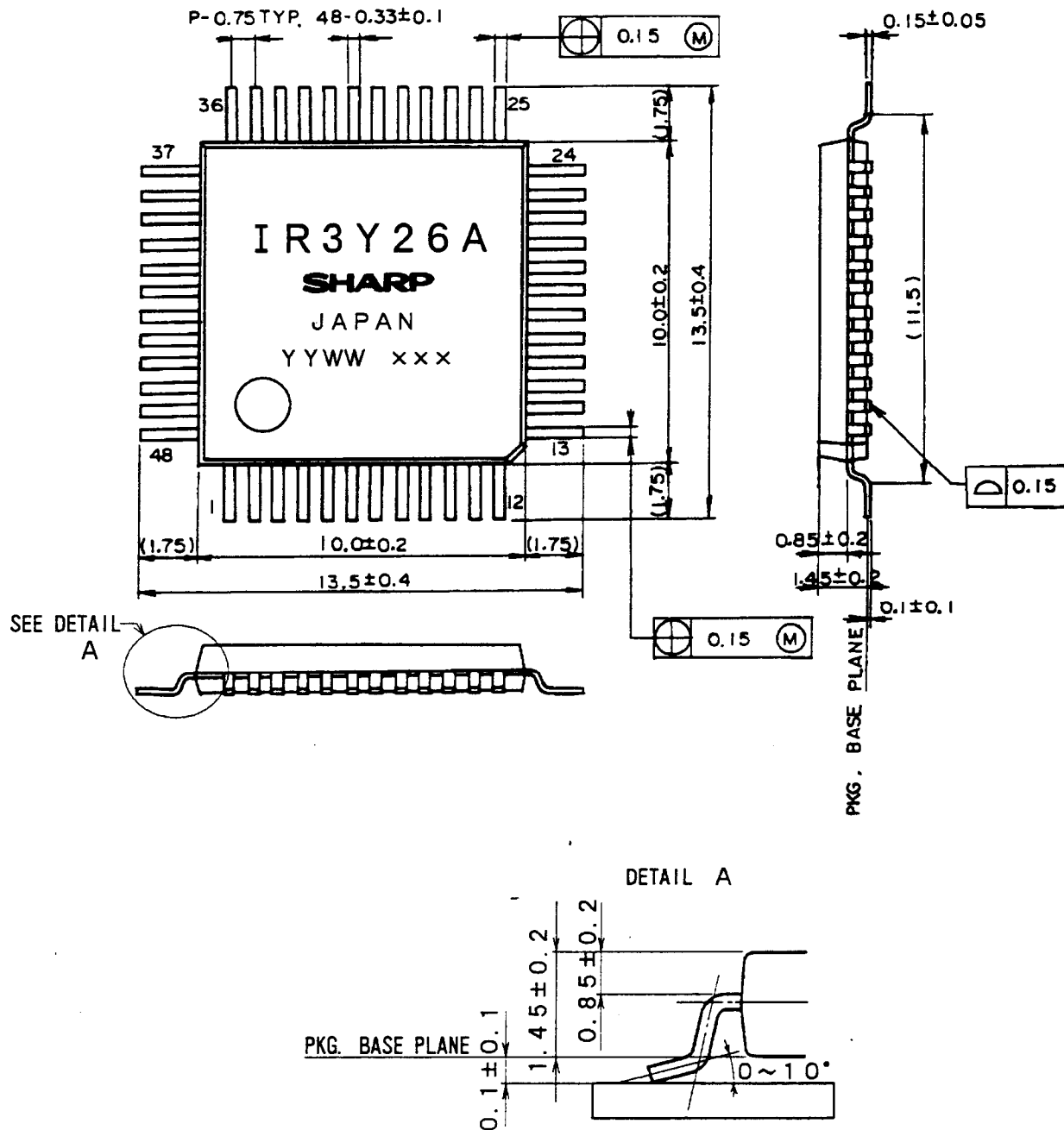

名称 NAME	QFP48-P-1010	リード仕上 LEAD FINISH	TIN-LEAD PLATING	備考 NOTE	プラスチックパッケージ外形寸法は、バリを含まないものとする。 Plastic body dimensions do not include burr of resin.
DRAWING NO.	AA873	単位 UNIT	mm		

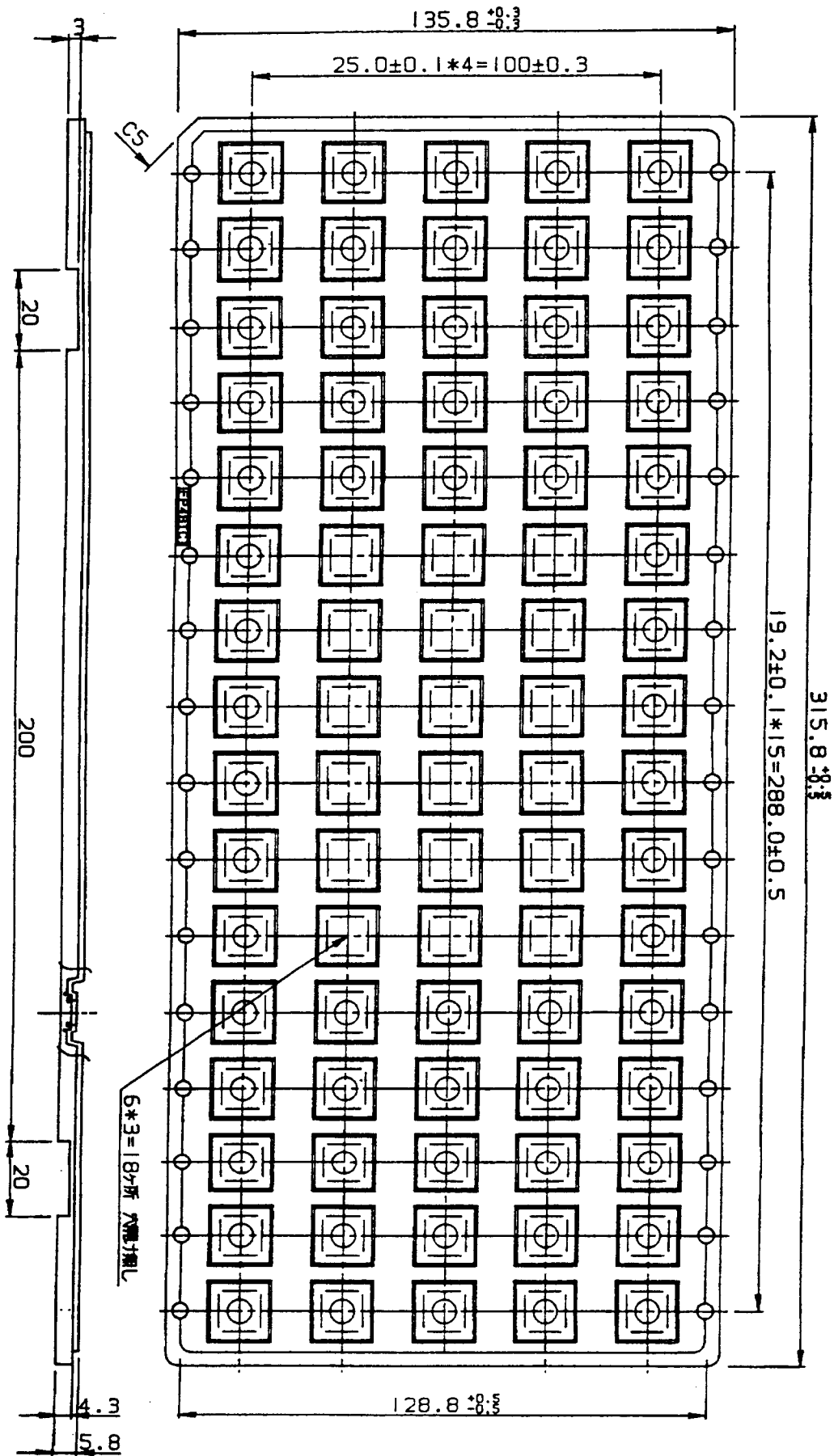

名称 NAME	FP48TCI		備考 NOTE
DRAWING NO.	CV561	单位 UNIT	mm