

4-channel BTL driver for CD players and CD-ROMs

BA5970FP

The BA5970FP is a 4-channel BTL driver developed to drive CD player motors and actuators. The driver input stage contains an operational amplifier, supports a variety of input formats, and allows simple configuration of a filter.

●Applications

CD players, CD-ROM

●Features

- 1) 4-channel BTL driver.
- 2) Wide dynamic range (4V when $PREV_{CC} = 8V$, $POWV_{CC} = 5V$, and $R_L = 8\Omega$).
- 3) Internal thermal shutdown circuit.
- 4) Driver gain is adjustable with externally connected resistor.
- 5) Independent power supplies $PREV_{CC}$, $POWV_{CC}$ (for channels 1 and 2), and $POWV_{CC}$ (for channels 3 and 4), and low voltage operation for a highly efficient drive.
- 6) Independent mute pins for channels 1 and 2 and channels 3 and 4.
- 7) Perfect for compact applications with the use of the HSOP28-pin power package.

●Absolute maximum ratings ($T_a = 25^\circ\text{C}$)

Parameter	Symbol	Limits	Unit
Power supply voltage	$PREV_{CC}$, $POWV_{CC}$	13.5	V
Power dissipation	P_d	1.7* ¹	W
Operating temperature	T_{opr}	-35~+85	°C
Storage temperature	T_{stg}	-55~+150	°C

*1 When mounted on a 70mm × 70mm × 1.6mm glass epoxy board with copper foil coverage of less than 3%.
Reduced by 13.6mW for each increase in T_a of 1°C over 25°C.

●Recommended operating conditions ($T_a = 25^\circ\text{C}$)

Parameter	Symbol	Limits	Unit
Power supply voltage	$PREV_{CC}$	4.5~13.2	V
	$POWV_{CC}$	4.5~ $PREV_{CC}$	V

● Block diagram

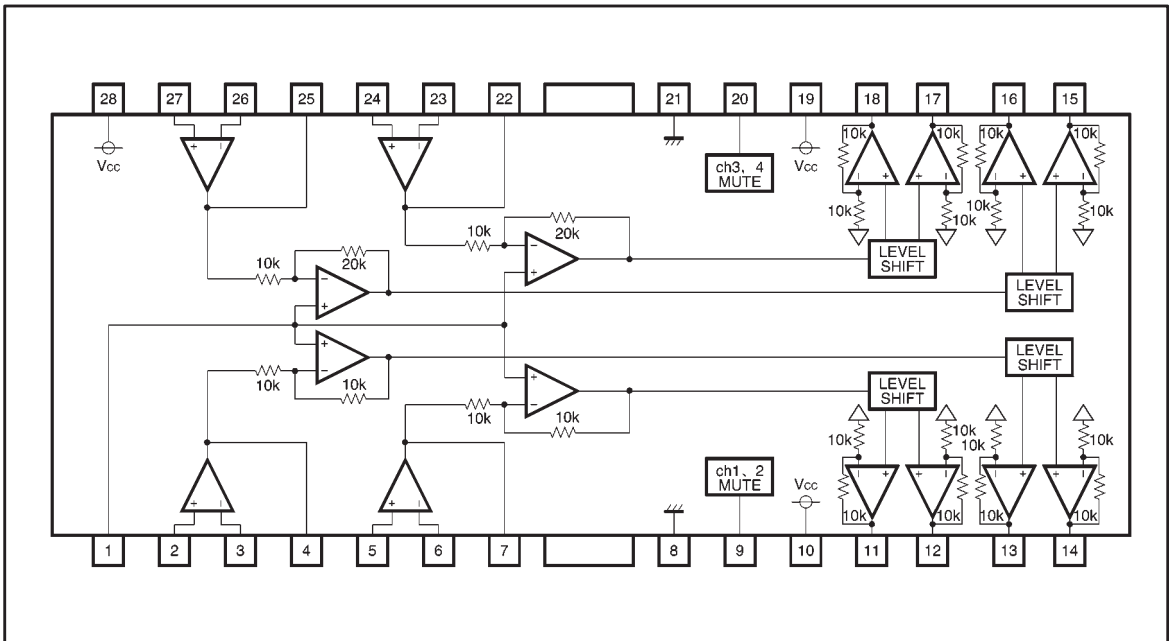

● Pin descriptions

Pin No.	Pin name	Function	Pin No.	Pin name	Function
1	BIAS IN	Bias amplifier input	15	VO4 (+)	Driver channel 4 positive output
2	OPIN1 (+)	Channel 1 pre-amplifier non-inverse input	16	VO4 (-)	Driver channel 4 negative output
3	OPIN1 (-)	Channel 1 pre-amplifier inverse input	17	VO3 (+)	Driver channel 3 positive output
4	OPOUT1	Channel 1 pre-amplifier output	18	VO3 (-)	Driver channel 3 negative output
5	OPIN2 (+)	Channel 2 pre-amplifier non-inverse input	19	POWVcc	POWVcc (channels 3 and 4)
6	OPIN2 (-)	Channel 2 pre-amplifier inverse input	20	MUTE2	Mute control for channels 3 and 4
7	OPOUT2	Channel 2 pre-amplifier output pin	21	GND	GND
8	GND	GND	22	OPOUT3	Channel 3 pre-amplifier output
9	MUTE1	Mute control for channels 1 and 2	23	OPIN3 (-)	Channel 3 pre-amplifier inverse input
10	POWVcc	POWVcc (channels 1 and 2)	24	OPIN3 (+)	Channel 3 pre-amplifier non-inverse input
11	VO2 (-)	Driver channel 2 negative output	25	OPOUT4	Channel 4 pre-amplifier output
12	VO2 (+)	Driver channel 2 positive output	26	OPIN4 (-)	Channel 4 pre-amplifier inverse input
13	VO1 (-)	Driver channel 1 negative output	27	OPIN4 (+)	Channel 4 pre-amplifier non-inverse input
14	VO1 (+)	Driver channel 1 positive output	28	PREVcc	PREVcc

Note : Positive output and negative output are the polarities with respect to the input.
(For example, if pin 4 voltage is high, then pin 14 voltage becomes high.)

● Input / output circuits

Pre-amplifier input

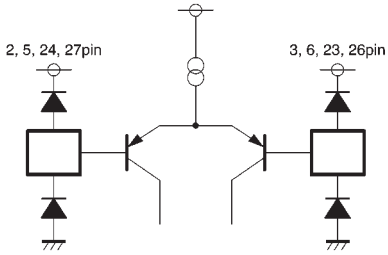

Driver output

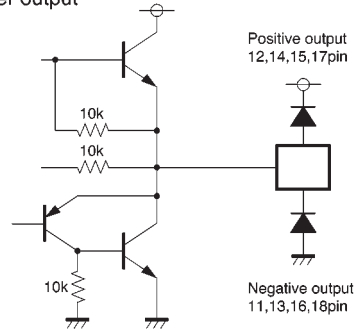

Pre-amplifier output (driver input)

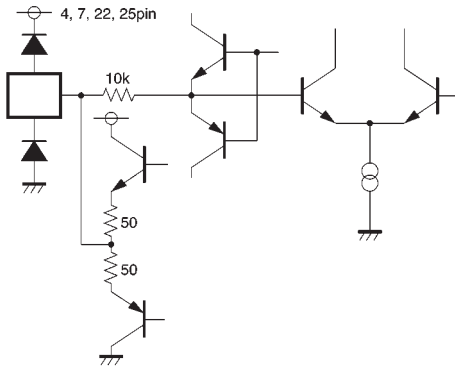

Mute

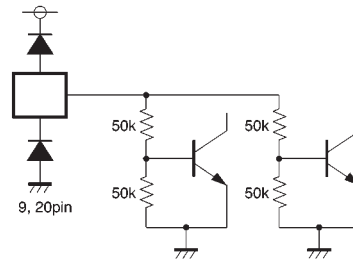

Bias

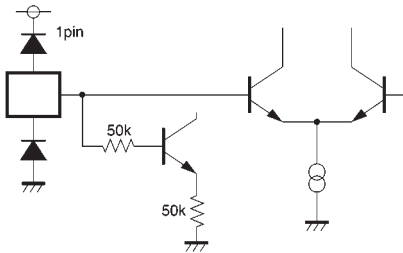

- Electrical characteristics (unless otherwise noted, Ta = 25°C, PREV_{CC} = 8V, POWV_{CC1} = 5V, POWV_{CC2} = 8V, BIAS = 2.5V, R_L = 8Ω)

Parameter	Symbol	Min.	Typ.	Max.	Unit	Conditions
Quiescent current	I _{Q1}	—	20	30	mA	Input open
〈Driver〉						
Output offset voltage 1	V _{OO1}	−70	0	70	mV	channel 1, 2
Output offset voltage 2	V _{OO2}	−90	0	90	mV	channel 3, 4
Maximum output amplitude 1	V _{OM1}	3.6	4.0	—	V	channel 1, 2, V _{IN} =±2.0V
Maximum output amplitude 2	V _{OM2}	5.4	6.0	—	V	channel 3, 4, V _{IN} =±2.0V
Voltage gain 1	G _{VC1}	10	12	14	dB	V _{IN} =±0.5V
Voltage gain 2	G _{VC2}	16	18	20	dB	V _{IN} =±0.5V
Mute on voltage	V _{MON}	2.0	—	—	V	
Mute off voltage	V _{MOFF}	—	—	0.5	V	
〈Pre-stage operational amplifier〉						
Common-mode input voltage	V _{ICM}	−0.3	—	6.8	mV	
Offset voltage	V _{OFOP}	−6	0	6	mV	
Input bias current	V _{BOP}	—	—	300	nA	
Output high level voltage	V _{OHOP}	6.9	7.35	—	V	
Output low level voltage	V _{LOP}	—	0.75	1.1	V	
Output drive current sink	I _{SI}	1	—	—	mA	50Ω at V _{CC}
Output drive current source	I _{SO}	1	—	—	mA	50Ω at GND
Slew rate	SR _{OP}	—	1	—	V/μs	100kHz rectangular wave, 2V _{P-P} output

©Not designed for radiation resistance.

● Measurement circuit

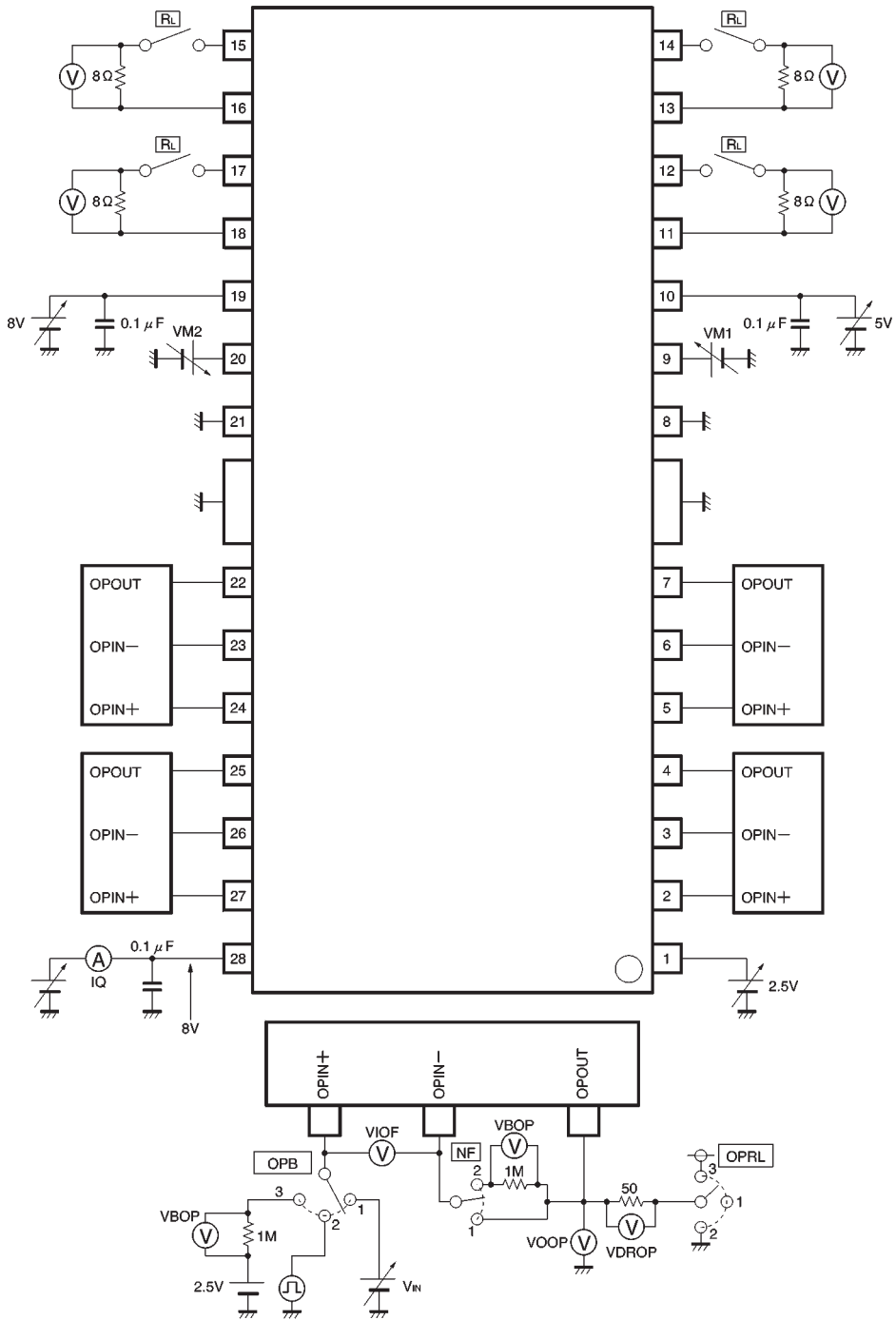

Fig.1

● Measurement circuit switch table

(1) Driver block (OPB → 1, NF → 1, OPRL → 1)

Symbol	Switch	Input		Remarks	Measurement point
	RL	V _{IN}	VM1, 2		
IQ	OFF	2.5V	0V	—	IQ
VOO1	ON	2.5V	0.5V	—	VO (channel 1, 2)
VOO2	ON	2.5V	0.5V	—	VO (channel 3, 4)
VOOM1	ON	±2.0V	0.5V	V _{IN} =0.5V and 4.5V	VO (channel 1, 2)
VOOM2	ON	±2.0V	0.5V	V _{IN} =0.5V and 4.5V	VO (channel 3, 4)
GVC1	ON	±0.5V	0.5V	V _{IN} =2.0V and 3.0V	VO (channel 1, 2)
GVC2	ON	±0.5V	0.5V	V _{IN} =2.0V and 3.0V	VO (channel 3, 4)
VMTON	ON	3.0V	2.0V	Verify output voltage is muted	VO
VMTOFF	ON	3.0V	0.5V	Verify output voltage is muted	VO

(2) Pre-stage operational amplifier block (VN1 = VM2 = 0V, RL → OFF)

Symbol	Switch			Input	Remarks	Measurement point
	OPB	NF	OPRL	V _{IN}		
VOFOP	1	1	1	2.5V	—	VIOF
VBOP	3	2	1	2.5V	—	VBOP/1MΩ
VOHOP	1	1	1	5V	—	VOOP
VOLOP	1	1	1	0V	—	VOOP
ISI	1	1	3	2.5V	—	VDROP/50Ω
ISO	1	1	2	2.5V	—	VDROP/50Ω
SR0P	2	1	1	±1V	100kHz rectangular wave, 2.5±1V input	VOOP

●Application example

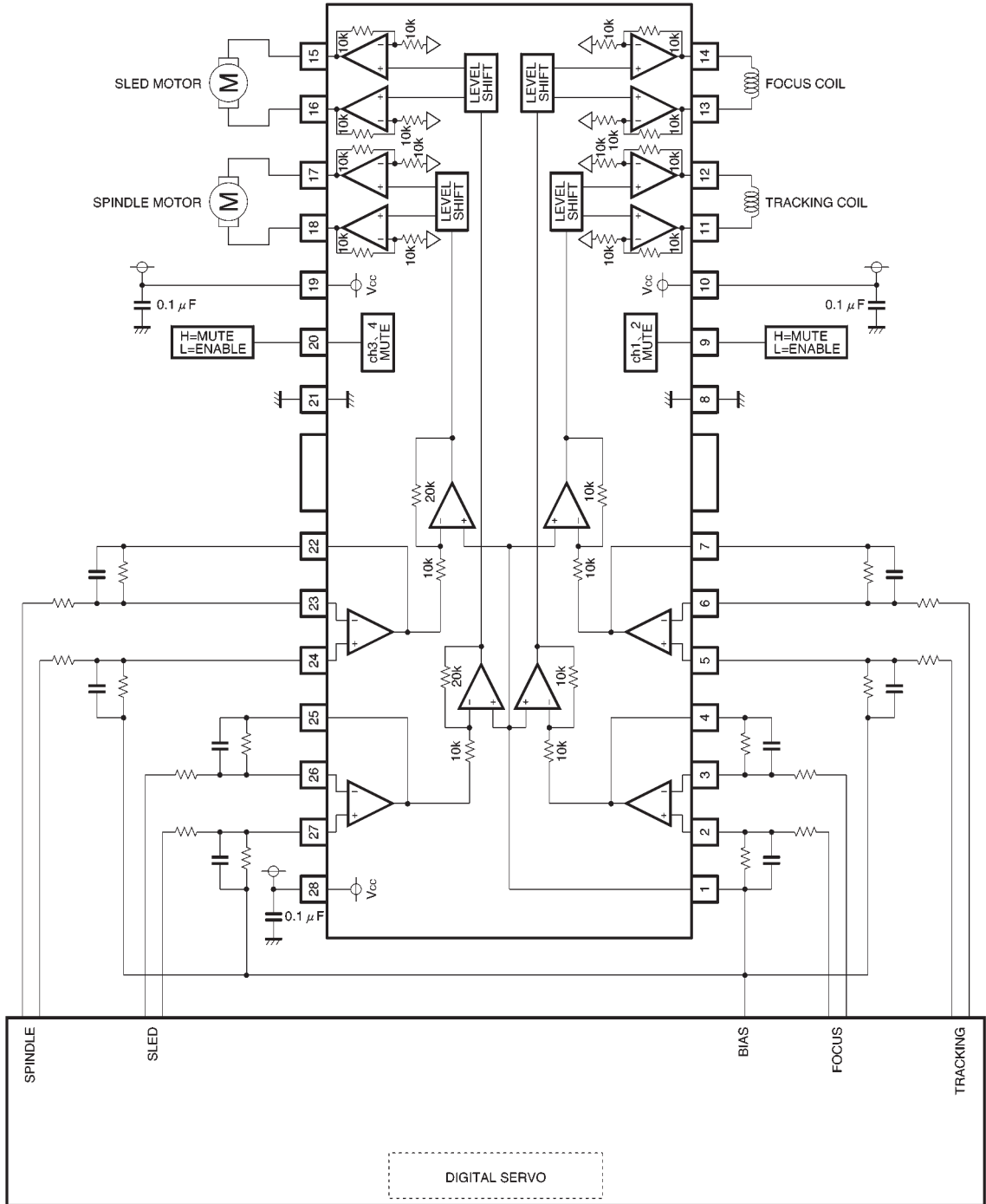

Fig.2

● Operation notes

- (1) The BA5970FP contains a thermal shutdown circuit. When the chip temperature reaches 175°C (Typ.), the output current is muted. If the chip temperature then drops below 150°C (Typ.), then the mute is released.
- (2) By having the mute pin voltage pulled up to 2.0V or greater, you can mute the output current. For normal conditions, have mute pin open or at 0.5V or below. (Pin 9 mutes channels 1 and 2, and pin 20 mutes channels 3 and 4.)
- (3) If the voltage of the bias pin (pin 1) drops below 1.4V (Typ.), outputs are muted. For normal conditions, have the voltage above 1.7V.
- (4) If the power supply voltage drops below 3.8V (Typ.),

internal circuits turns off. If the power supply voltage then rises to 4.0V (Typ.), the circuits turn on.

- (5) If the voltage of the thermal shutdown, mute ON, or bias pin drops, or if the power supply voltage drops, the mute is activated; however, in these situations, only the drivers are muted. Also, the output pin voltage becomes the internal bias voltage (approx. $V_{CC}/2$ for channels 1 and 2, and $(V_{CC}-V_F)/2$ for channels 3 and 4).
- (6) Connect a bypass capacitor (approx. 0.1μF) between the bases of the power supply pins of this IC.
- (7) Even though the radiation fins are connected to ground within the package, be sure to also connect them to a ground externally as well.

● Electrical characteristic curves

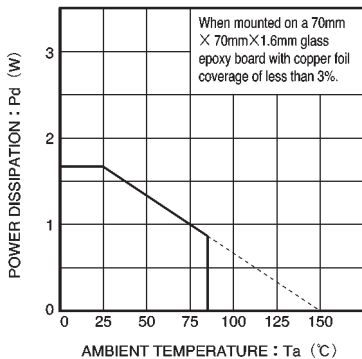

Fig.3 Thermal derating curve

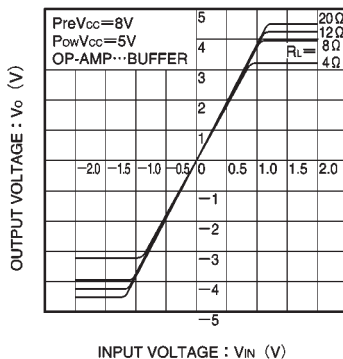

Fig.4 I/O characteristics (channels 1 and 2)

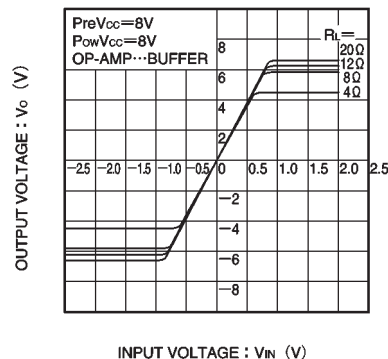

Fig.5 I/O characteristics (channels 3 and 4)

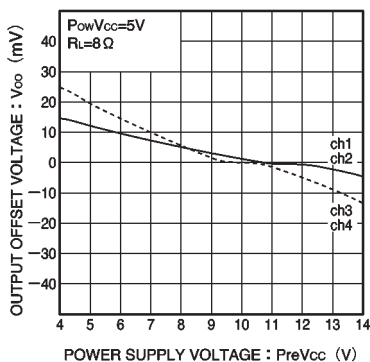

Fig.6 Power supply voltage vs. output offset voltage

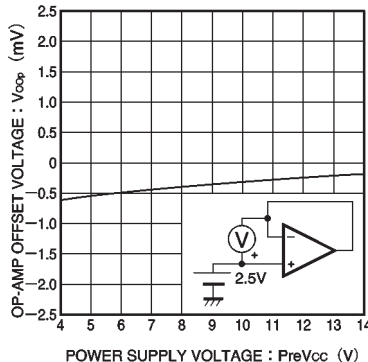

Fig.7 Power supply voltage vs. operational amplifier offset voltage

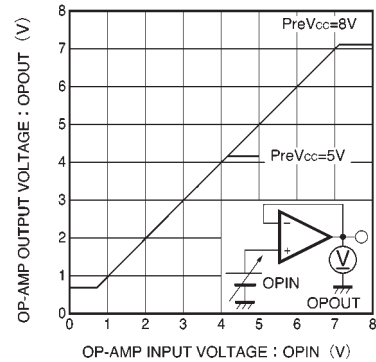

Fig.8 Operational amplifier I/O characteristics

● External dimensions (Units: mm)

