



LCD-Monitor

Chassis
LS17PEA
LS19PEB

Model
732N
932B

SERVICE Manual

TFT-LCD Monitor



Fashion Feature

- Lustrous/Colorful Appearance (Design)
- Integrated UI applied
- Built-in Scaler Sync Separator
- Connectivity :
 - 17" - Analog (15p Dsub)
 - 19" - Analog (15p Dsub),
Dual (24p DVI-D)
- Power Consumption : 17"(34W), 19"(38W)
- DPMS : under 1 W (230Vac)

Copyright

©2006 by Samsung Electronics Co., Ltd.

All rights reserved.

This manual may not, in whole or in part, be copied, photocopied, reproduced, translated, or converted to any electronic or machine readable form without prior written permission of Samsung Electronics Co., Ltd.

LS17PEA/LS19PEB Service Manual

First edition February 2006.

Printed in Korea.

Trademarks

Samsung is the registered trademark of Samsung Electronics Co., Ltd.

LS17PEA/LS19PEB and MacMaster Cable Adapter are trademarks of Samsung Electronics Co., Ltd.

Macintosh, Power Macintosh are trademarks of Apple Computer, Inc.

All other trademarks are the property of their respective owners.

Contents

1. Precautions	1-1
1-1 Safety Precautions	1-1
1-2 Servicing Precautions	1-2
1-3 Electrostatically Sensitive Devices (ESD) Precautions	1-2
1-4 Installation Precautions	1-3
2. Product specifications	2-1
2-1 Fashion Feature	2-1
2-2 LS17PEA Specifications	2-1
2-3 LS19PEB Specifications	2-2
2-4 Spec Comparison	2-3
2-5 Option Specification	2-4
3. Alignments and Adjustments	3-1
3-1 Required Equipment	3-1
3-2 Automatic Color Adjustment	3-1
3-3 DDC EDID Data Input	3-1
3-4 OSD Adjustment When Replacing Panel	3-1
3-5 OSD Adjustment When Replacing Lamp Only	3-1
3-6 Service Function Spec.	3-2
3-7 How to execute DDC	3-4
3-8 How to execute MCU Code	3-5
4. Troubleshooting	4-1
4-1 No Power (17", 19")	4-1
4-2 No Video (ANALOG 17", 19")	4-2
4-3 No Video (DIGITAL 19")	4-4
5. Exploded View and Parts List	5-1
5-1 LS17PEA Exploded View	5-1
5-2 Parts List	5-2
5-3 LS19PEB Exploded View	5-3
5-4 Parts List	5-4
6. Electrical Parts List	6-1
6-1 LS17PEA Parts List	6-1
6-2 LS19PEB Parts List	6-6

Contents

7. Block Diagram	7-1
7-1 Power Tree	7-1
7-2 Main Board Part (17")	7-2
7-3 Main Board Part (19")	7-3
7-4 IP Board Part (SMPS Part)	7-4
7-5 IP Board Part (Inverter Part)	7-5
8. Wiring Diagram	8-1
8-1 Wiring Diagram 17"	8-1
8-2 Wiring Diagram 12"	8-2
9. Schematic Diagrams	9-1
9-1 Schematic Diagrams (17")	9-1
9-2 Schematic Diagrams (19")	8-2
10. Operating Instructions and Installation	10-1
10-1 Front	10-1
10-2 Rear	10-2
10-3 Connecting the monitor	10-3
11. Disassembly and Reassembly	11-1
11-1 Disassembly	11-1
11-2 Reassembly	11-6
12. PCB Diagram	12-1
12-1 Main PCB (17")	12-1
12-2 Main PCB (19")	12-2
13. Circuit Descriptions	13-1
13-1 Overall Block Structure	13-1
13-2 Trouble Shooting	13-5
13-3 IP BOARD(Power) Schematic Diagrams	13-8
13-4 IP BOARD(Inverter) Schematic Diagrams	13-9
14. Reference Information	
14-1 Technical Terms	14-1
14-2 Pin Assignments	14-3
14-3 Timing Chart	14-4
14-4 Preset Timing Modes	14-5
14-5 Panel Description	14-6

1 Precautions

Follow these safety, servicing and ESD precautions to prevent damage and to protect against potential hazards such as electrical shock.

1-1 Safety Precautions

1-1-1 Warnings

1. For continued safety, do not attempt to modify the circuit board.
2. Disconnect the AC power and DC power jack before servicing.

1-1-2 Servicing the LCD Monitor

1. When servicing the LCD Monitor, Disconnect the AC line cord from the AC outlet.
2. It is essential that service technicians have an accurate voltage meter available at all times. Check the calibration of this meter periodically.

1-1-3 Fire and Shock Hazard

Before returning the monitor to the user, perform the following safety checks:

1. Inspect each lead dress to make certain that the leads are not pinched or that hardware is not lodged between the chassis and other metal parts in the monitor.
2. Inspect all protective devices such as nonmetallic control knobs, insulating materials, cabinet backs, adjustment and compartment covers or shields, isolation resistor-capacitor networks, mechanical insulators, etc.
3. Leakage Current Hot Check (Figure 1-1):

WARNING : Do not use an isolation transformer during this test.

Use a leakage current tester or a metering system that complies with American National Standards Institute (*ANSI C101.1, Leakage Current for Appliances*), and Underwriters Laboratories (*UL Publication UL1410, 59.7*).

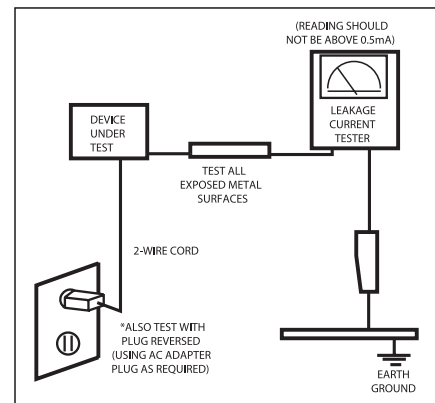

Figure 1-1. Leakage Current Test Circuit

4. With the unit completely reassembled, plug the AC line cord directly into a 120V AC outlet. With the unit's AC switch first in the ON position and then OFF, measure the current between a known earth ground (metal water pipe, conduit, etc.) and all exposed metal parts, including: metal cabinets, screwheads and control shafts. The current measured should not exceed 0.5 milliamp. Reverse the power-plug prongs in the AC outlet and repeat the test.

1-1-4 Product Safety Notices

Some electrical and mechanical parts have special safety-related characteristics which are often not evident from visual inspection. The protection they give may not be obtained by replacing them with components rated for higher voltage, wattage, etc. Parts that have special safety characteristics are identified by \triangle on schematics and parts lists. A substitute replacement that does not have the same safety characteristics as the recommended replacement part might create shock, fire and/or other hazards. Product safety is under review continuously and new instructions are issued whenever appropriate.

1 Precautions

1-2 Servicing Precautions

WARNING: An electrolytic capacitor installed with the wrong polarity might explode.

Caution: Before servicing units covered by this service manual, read and follow the Safety Precautions section of this manual.

Note: If unforeseen circumstances create conflict between the following servicing precautions and any of the safety precautions, always follow the safety precautions.

1-2-1 General Servicing Precautions

1. Always unplug the unit's AC power cord from the AC power source and disconnect the DC Power Jack before attempting to:
(a) remove or reinstall any component or assembly, (b) disconnect PCB plugs or connectors, (c) connect a test component in parallel with an electrolytic capacitor.
2. Some components are raised above the printed circuit board for safety. An insulation tube or tape is sometimes used. The internal wiring is sometimes clamped to prevent contact with thermally hot components. Reinstall all such elements to their original position.
3. After servicing, always check that the screws, components and wiring have been correctly reinstalled. Make sure that the area around the serviced part has not been damaged.
4. Check the insulation between the blades of the AC plug and accessible conductive parts (examples: metal panels, input terminals and earphone jacks).
5. Insulation Checking Procedure: Disconnect the power cord from the AC source and turn the power switch ON. Connect an insulation resistance meter (500 V) to the blades of the AC plug.
The insulation resistance between each blade of the AC plug and accessible conductive parts (see above) should be greater than 1 megohm.
6. Always connect a test instrument's ground lead to the instrument chassis ground before connecting the positive lead; always remove the instrument's ground lead last.

1-3 Electrostatically Sensitive Devices (ESD) Precautions

Some semiconductor (solid state) devices can be easily damaged by static electricity. Such components are commonly called Electrostatically Sensitive Devices (ESD). Examples of typical ESD are integrated circuits and some field-effect transistors. The following techniques will reduce the incidence of component damage caused by static electricity.

1. Immediately before handling any semiconductor components or assemblies, drain the electrostatic charge from your body by touching a known earth ground. Alternatively, wear a discharging wrist-strap device. To avoid a shock hazard, be sure to remove the wrist strap before applying power to the monitor.
2. After removing an ESD-equipped assembly, place it on a conductive surface such as aluminum foil to prevent accumulation of an electrostatic charge.
3. Do not use freon-propelled chemicals. These can generate electrical charges sufficient to damage ESDs.
4. Use only a grounded-tip soldering iron to solder or desolder ESDs.
5. Use only an anti-static solder removal device. Some solder removal devices not classified as "anti-static" can generate electrical charges sufficient to damage ESDs.
6. Do not remove a replacement ESD from its protective package until you are ready to install it. Most replacement ESDs are packaged with leads that are electrically shorted together by conductive foam, aluminum foil or other conductive materials.
7. Immediately before removing the protective material from the leads of a replacement ESD, touch the protective material to the chassis or circuit assembly into which the device will be installed.
Caution: Be sure no power is applied to the chassis or circuit and observe all other safety precautions.
8. Minimize body motions when handling unpackaged replacement ESDs. Motions such as brushing clothes together, or lifting your foot from a carpeted floor can generate enough static electricity to damage an ESD.

1-4 Installation Precautions

1. For safety reasons, more than two people are required for carrying the product.
2. Keep the power cord away from any heat emitting devices, as a melted covering may cause fire or electric shock.
3. Do not place the product in areas with poor ventilation such as a bookshelf or closet. The increased internal temperature may cause fire.
4. Bend the external antenna cable when connecting it to the product. This is a measure to protect it from being exposed to moisture. Otherwise, it may cause a fire or electric shock.
5. Make sure to turn the power off and unplug the power cord from the outlet before repositioning the product. Also check the antenna cable or the external connectors if they are fully unplugged. Damage to the cord may cause fire or electric shock.
6. Keep the antenna far away from any high-voltage cables and install it firmly. Contact with the highvoltage cable or the antenna falling over may cause fire or electric shock.
7. When installing the product, leave enough space (10cm) between the product and the wall for ventilation purposes.
A rise in temperature within the product may cause fire.

1 Precautions

Memo

2 Product Specifications

2-1 Fashion Feature

- Minimalism Design Something New
- Boltless Model (Clean Cut & Soft Surface)
- New Ball Hinge
- Color Variation. White, Black

2-2 LS17PEA Specifications

Item	Description
LCD Panel	TFT-LCD panel, RGB vertical stripe, normally black transmissive, 17-Inch viewable, 0.264 (H) x 0.264 (V) mm pixel pitch
Scanning Frequency	Horizontal : 31 kHz ~ 81 kHz (Automatic) Vertical : 56 Hz ~ 75 Hz (UXGA : 60 Hz)
Display Colors	16.7 Million colors
Maximum Resolution	Horizontal : 1280 Pixels Vertical : 1024 Pixels
Input Signal	Analog
Input Sync Signal	Seperate H/V sync, Composite H/V, Sync-on-Green, Automatic synchronization without external switch of sync type Level : TTL level
Maximum Pixel Clock rate	135 MHz
Active Display Horizontal/Vertical	337(H) x 270(W) mm
AC power voltage & Frequency	AC 90 ~ 264 Volts, 60/50 Hz
Power Consumption	34W (Max)
Dimensions Set (W x D x H)	376.0 x 177.0 x 380.0 mm
Weight (Set/Package)	3.2kg / 4.3kg
Environmental Considerations	Operating Temperature : 0°F ~ 122°F (0°C ~ 50°C) Operating Humidity : 20% ~ 90% Storage temperature : -4°F ~ 149°F (-20°C ~ 65°C) Storage Humidity : 5% ~ 90%
- Designs and specifications are subject to change without prior notice.	



2-3 LS19PEB Specifications

Item	Description
LCD Panel	TFT-LCD panel, RGB vertical stripe, normally black transmissive, 19-Inch viewable, 0.294 (H) x 0.294 (V) mm pixel pitch
Scanning Frequency	Horizontal : 31 kHz ~ 81 kHz (Automatic) Vertical : 56 Hz ~ 75 Hz (UXGA : 60 Hz)
Display Colors	16.7 Million colors
Maximum Resolution	Horizontal : 1280 Pixels Vertical : 1024 Pixels
Input Signal	Analog / Digital
Input Sync Signal	Seperate H/V sync, Composite H/V, Sync-on-Green, Automatic synchronization without external switch of sync type Level : TTL level
Maximum Pixel Clock rate	135 MHz
Active Display Horizontal/Vertical	376.3(H) x 301.05(W) mm
AC power voltage & Frequency	AC 90 ~ 264 Volts, 60/50 Hz
Power Consumption	38W (Max)
Dimensions Set (W x D x H)	418.0 x 199.0 x 418.0 mm
Weight (Set/Package)	4.0kg / 5.3kg
Environmental Considerations	Operating Temperature : 0°F ~ 122°F (0°C ~ 50°C) Operating Humidity : 20% ~ 90% Storage temperature : -4°F ~ 149°F (-20°C ~ 65°C) Storage Humidity : 5% ~ 90%
- Designs and specifications are subject to change without prior notice.	

2-4 Spec Comparison

Model	BI17BS / 19BS	LS17PEA / LS19PEB
Design		
Frequency Horizontal Vertical Display Color	30 ~ 81 kHz 60 ~ 75 Hz 16,2M colors	30 ~ 81 kHz 60 ~ 75 Hz 16,7M colors
PC Resolution Maximum mode	1280 x 1024 / 60 Hz	1280 x 1024 / 60 Hz
Input Signal Sync Signal Video Signal	H/V Separate, TTL, P. or N. 0.7 Vp-p @ 75ohm	H/V Separate, TTL, P. or N. 0.7 Vp-p @ 75ohm
Power Consumption Normal Power Saving	34W / 38W < 1W	34W / 38W < 1W
Response Time	8ms	17" : 5ms 19" : 5ms
Anion Option	None	None
Magic Color	Support	Support (Deleted Magic Zone)

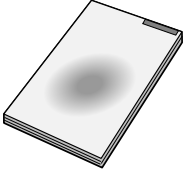
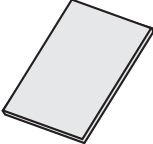
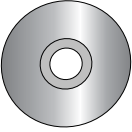
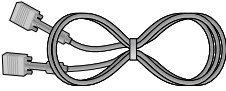
2-5 Option Specification

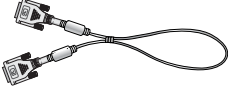
Item	Item Name	CODE.NO	Remark
	Quick Setup Guide	BN68-01002C	
	Warranty Card (Not available in all locations)	AA68-00371C	
	User's Guide, Monitor Driver, Natural Color software, MagicTune™ software	BN59-00585A	
	D-Sub(15 Pin) Cable	BN39-00244B	
	Power Cord	3903-000042	
	DVI Cable	BN39-00246F	Sold separately

3 Alignments and Adjustments

This section of the service manual explains how to use the DDC MANAGER JIG.
This function is needed for AD board change and program memory (IC110) change.

3-1 Required Equipment

The following equipment is necessary for adjusting the monitor:

- Computer with Windows 95, Windows 98, or Windows NT.
- MTI-2031 DDC MANAGER JIG

3-2 Automatic Color Adjustment

To input video, use 16 gray or any pattern using black and white.

1. Select english for OSD language.
2. Press the "  (Enter/Source)" key for 5 seconds.

3-3 DDC EDID Data Input

1. Input DDC EDID data when replacing AD PCB.
2. Receive/Download the proper DDC file for the model from HQ quality control department.
Install the below jig (Figure 1) and enter the data.

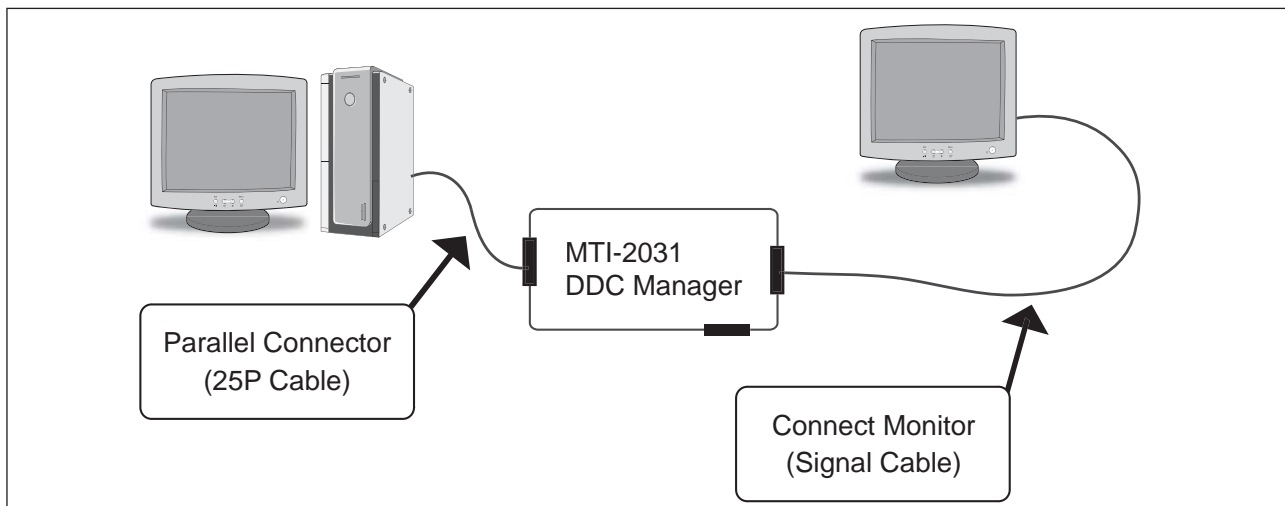



Figure 1.

3-4 OSD Adjustment When Replacing Panel

1. Adjust brightness and contrast to 0. Then, press the  (Enter/Source) key for 5 seconds.
Service function OSD will appear on screen.
2. Press the + key to place the cursor on the panel. Press the menu key for 5 seconds.

3-5 OSD Adjustment When Replacing Lamp Only

1. Adjust brightness and contrast to 0. Then, press the exit key for 5 seconds.
Service function OSD will appear on the screen.
2. Press the + key. Select upper lamp and press the menu key for 5 seconds.
Then, select lower lamp and press the menu key for 5 seconds.

Note : Please be sure to read the following instructions for details on service function.

3-6 Service Function Spec.

3-6-1 How to Display Service Function OSD

1. The value for brightness and contrast should be changed to zero.
2. Within 5 seconds, press the (Enter/Source) key.
3. Service function OSD will be displayed.

-If you want to disable the service function OSD, you will have to power off.

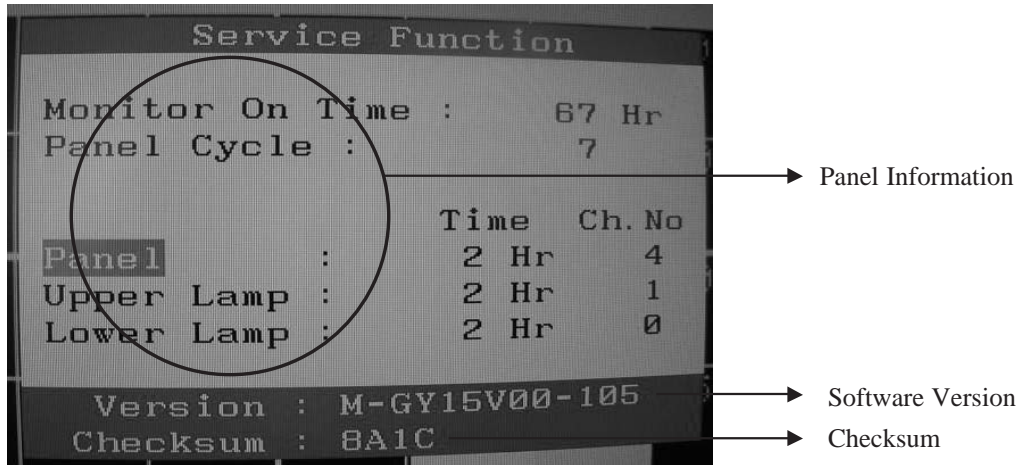

Figure 2. The example of service function OSD

The service function OSD is based on a grid of 29 columns x 12 rows.

The service function OSD consists of panel information, software version and MICOM checksum.

3-6-2 How to Control Service Function OSD

1. With the panel selected on OSD, whenever you press the right key, the base color will change to blue from "Panel" to "Upper Lamp", "Lower Lamp".

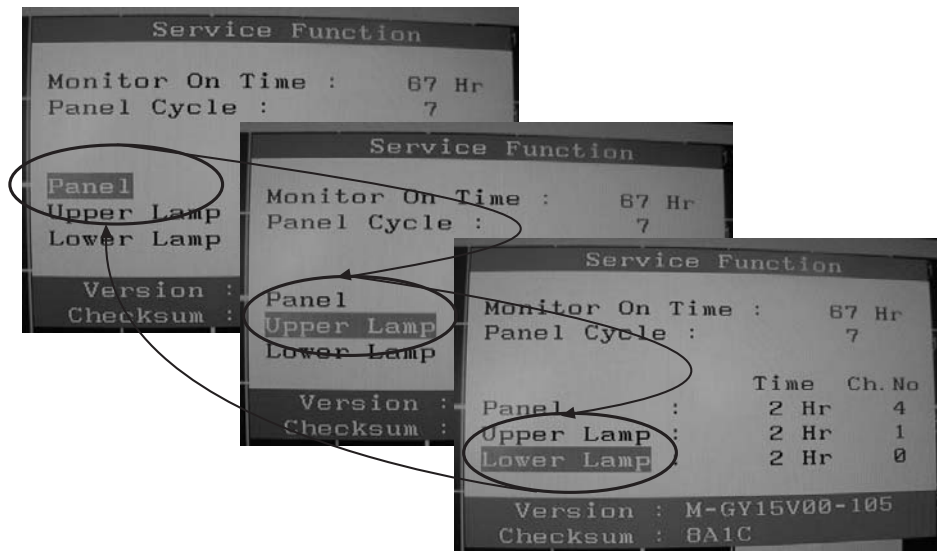

Figure 3.

3-6-3 How to Control Service Function OSD

-After changing the panel or lamp, you must reset service function OSD.

-The case of panel change

After changing the panel, press the menu key within 5 seconds,.

Then, panel Ch. No increases one step and the panel time information is reset to zero.

Simultaneously, other information is reset to zero (Upper/Lower lamp, Panel cycle).

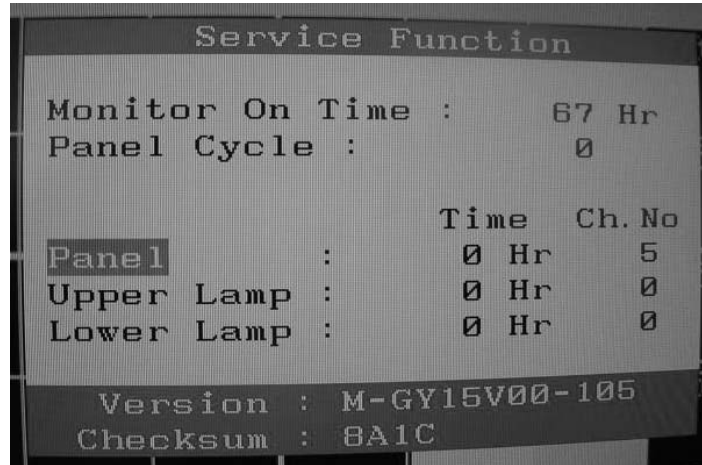

Figure 4.

3-6-4 How to Control Service Function OSD

-In the case of Upper Lamp or Lower Lamp change

After changing the Upper Lamp or Lower Lamp,

1. Select the Upper Lamp or Lower Lamp
2. Press the Menu key within an 5 seconds.

Then, Ch. No and time will be reset to zero (selected item only).

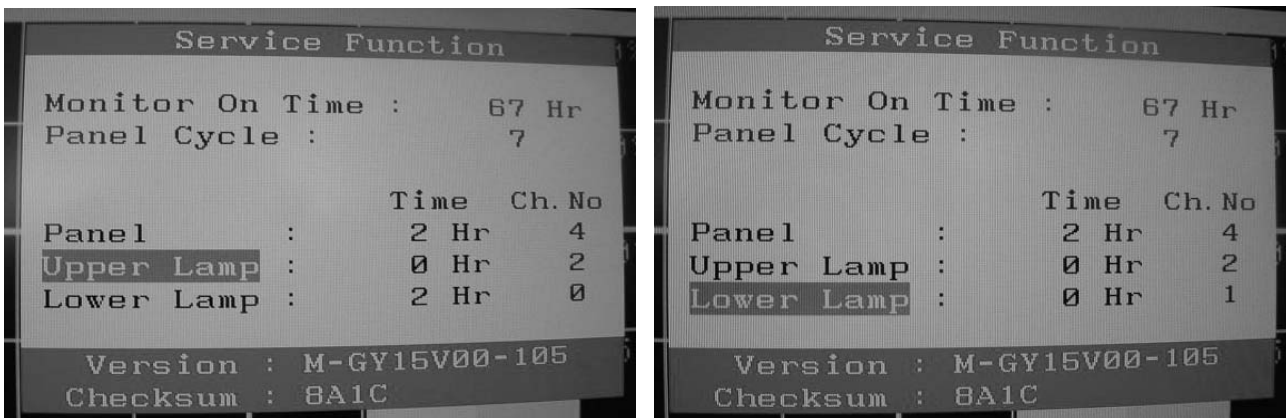

Figure 5, 6.

3 Alignments and Adjustments

3-7 How to execute DDC

3-7-1 After exchange the Main PBA, confirm below items

1. PC color status check (Auto Color)
2. EDID Input (Analog and Digital)
3. Check the MCU Code
(After change MCU Code, Do Auto color)
4. Factory Reset

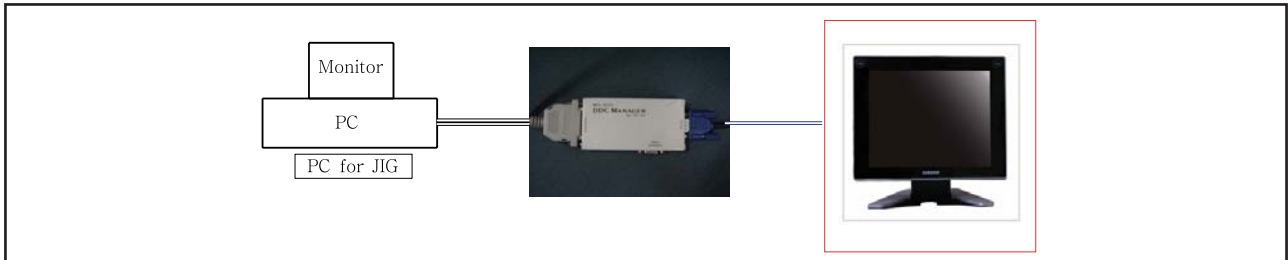

- 1) Run DDC Manager MTI-2050.
- 2) Select a DDC file name.
Program : WinDDC BY SAMSUNG ELEC.Co. [Ver:4.65.12V] --- Modify : 20050425
DDC : 732N.ddc or 932B.ddc
- 3) Insert into DDC Manager Port 1 (analog) and make the DDC input as for the old dual model.
- 4) Insert into DDC Manager Port 2 (Digital) and make the DDC input.

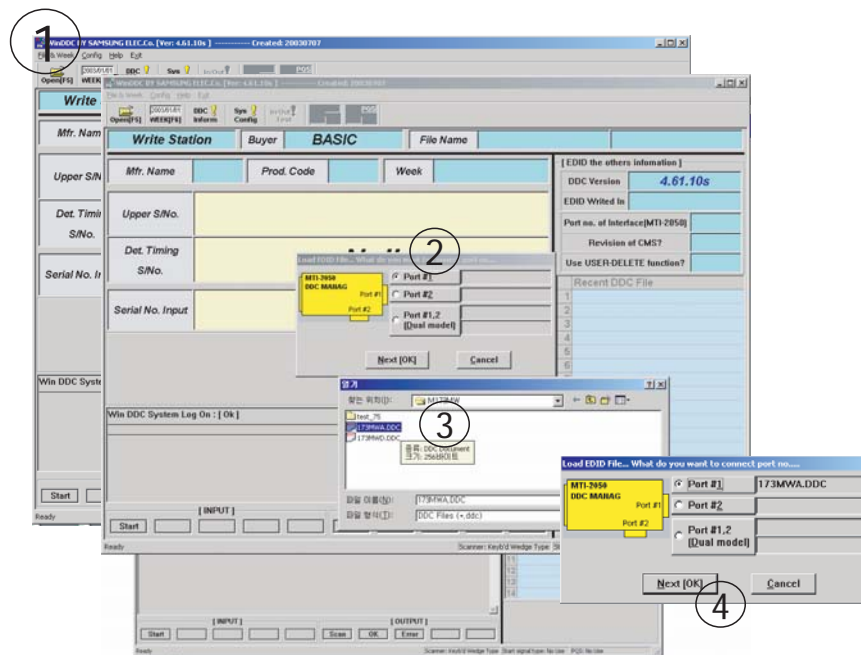

1. Open file.
2. Select Port #1.
3. Select DDC file.
4. Click, "Next" Button

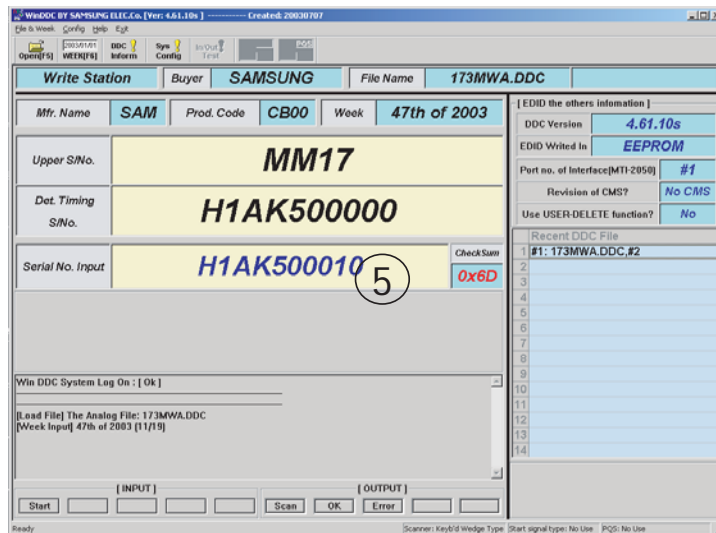

5. Type in the monitor serial number and press Enter.
- *Repeat this step 2 to 5 times in digital inputs after the analog input.

3-8 How to execute MCU Code

3-8-1 Program Setting - Config Setting

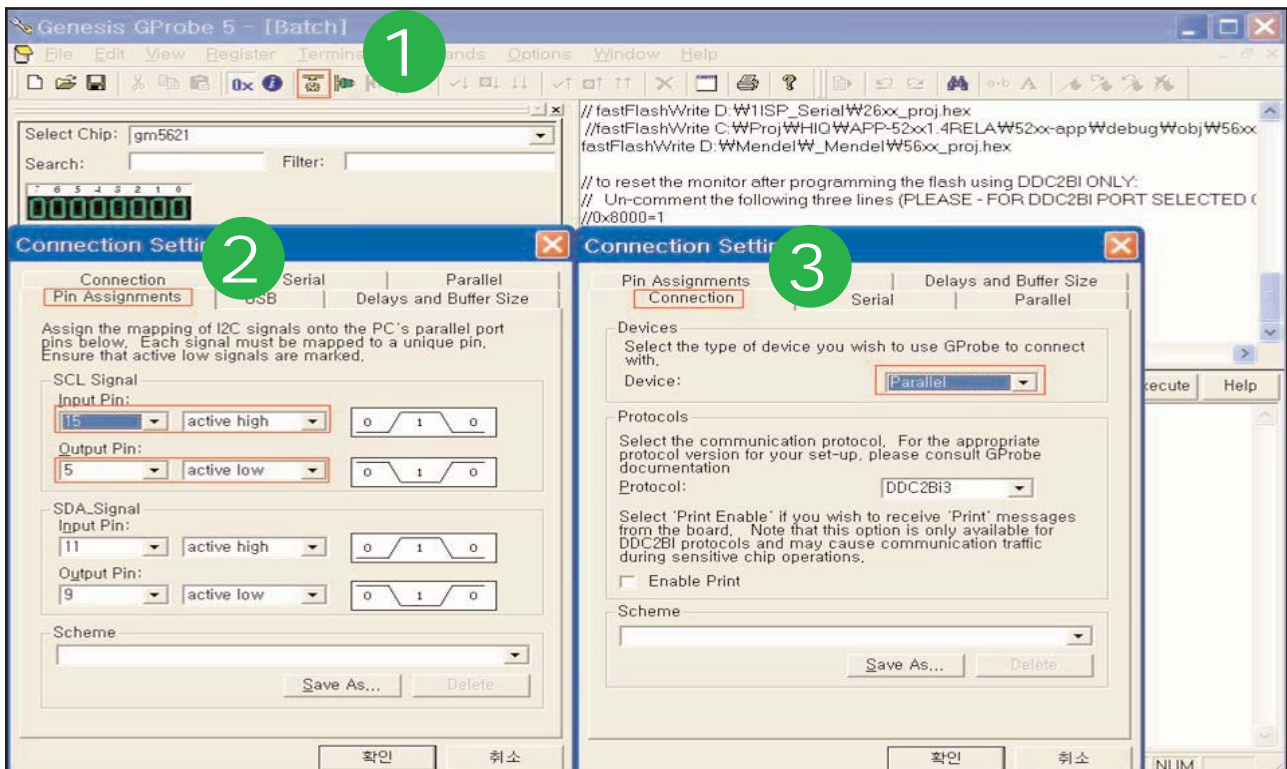

1. Click Config Setting
2. Change SCL Signal at Pin Assignments
3. Set Device to Parallel

3 Alignments and Adjustments

3-8-2 Change Batch File Path and DownLoad Code

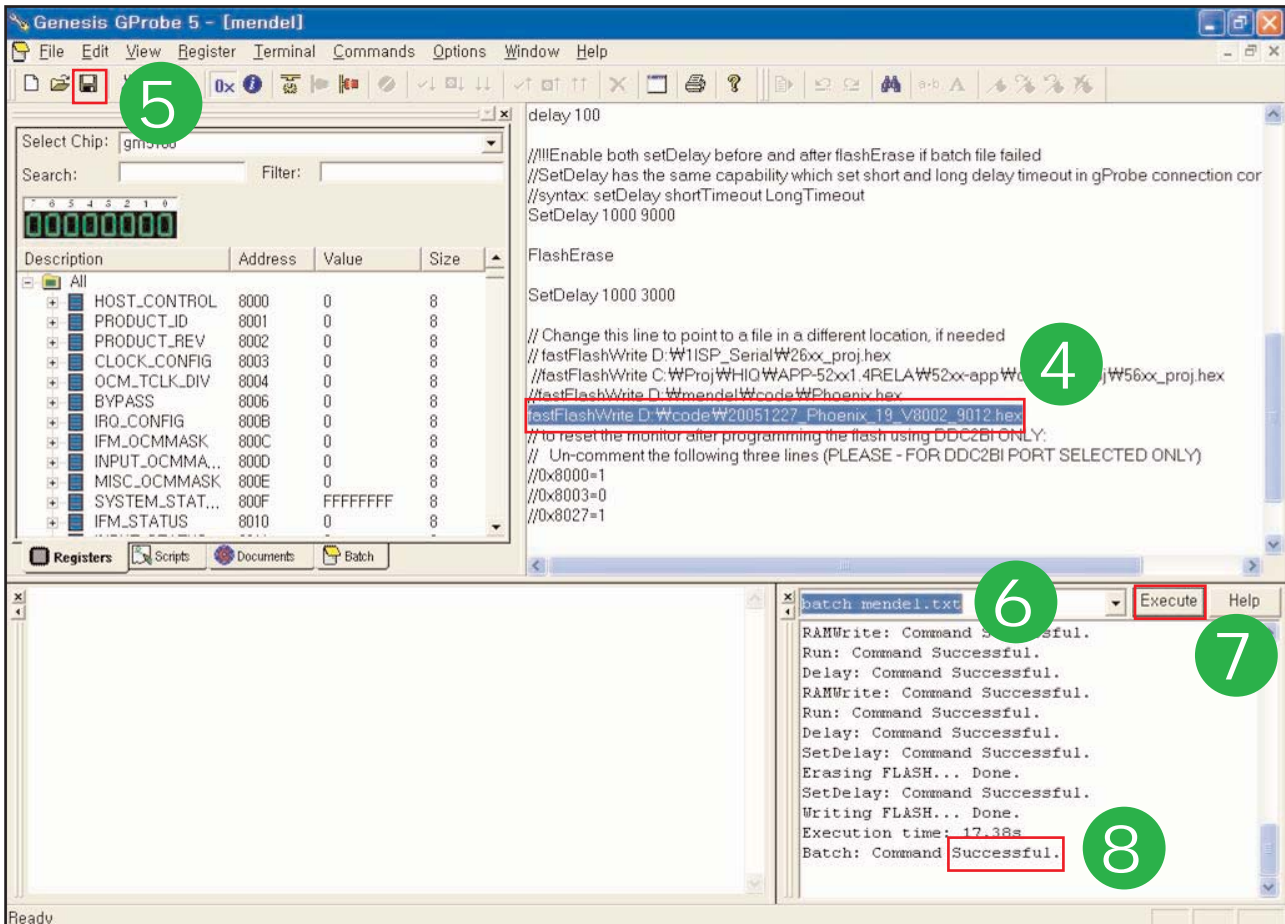

4. Change the Code's Path to saved Path at your PC.

5. Save the Batch file.

6. Write Batch command
"batch batch file name.txt"

7. Click "Execute" Button

8. If command is "Successful" , Hard Power On/Off until LED is Off

- If command is "Error",

1. Hard Power Off

2. Write Command "forcesa"

3. Click "Execute" Button

4. Repeat again 7 to 9.

4 Troubleshooting

- Notes:
- Before troubleshooting, setup the PC's display as below.
 - Resolution: 1024 x 768
 - H-frequency: 61 kHz
 - V-frequency: 75 Hz
 - If no picture appears, make sure the power cord is correctly connected.
 - Check the following circuits.
 - No raster appears: Function PBA, Main PBA, I/P PBA
 - 5V develop but no screen: Main PBA
 - 5V does not develop: I/P PBA
 - If you push and hold the " (Enter/Source)" button for more than 5 seconds, the monitor automatically returns to the factory preset.

4-1 No Power (17", 19")

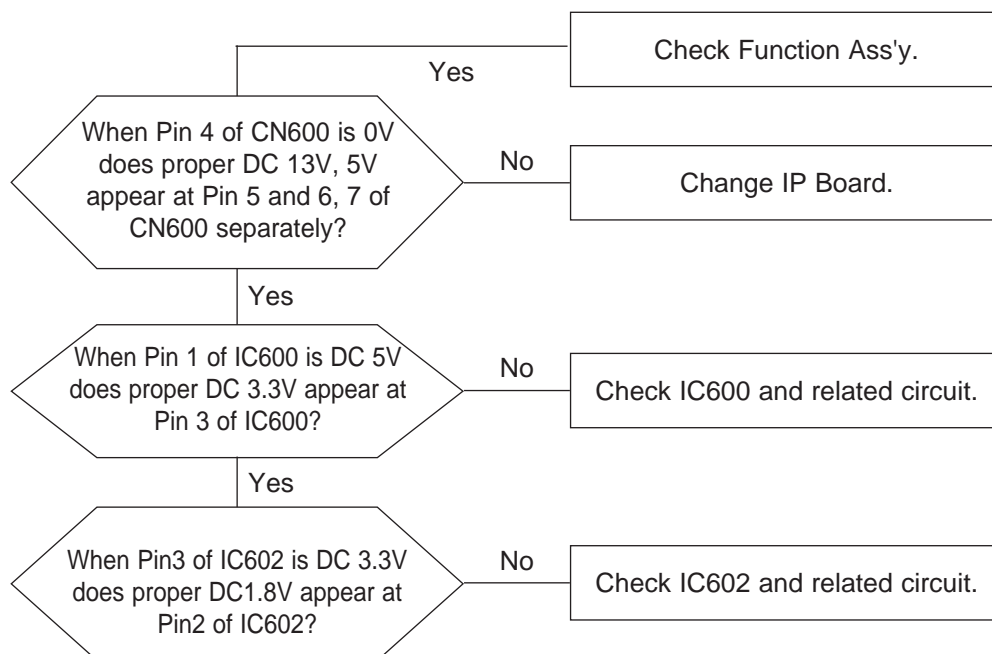

* All locations of this page includes Main PBA.

4-2 No Video (ANALOG 17", 19")

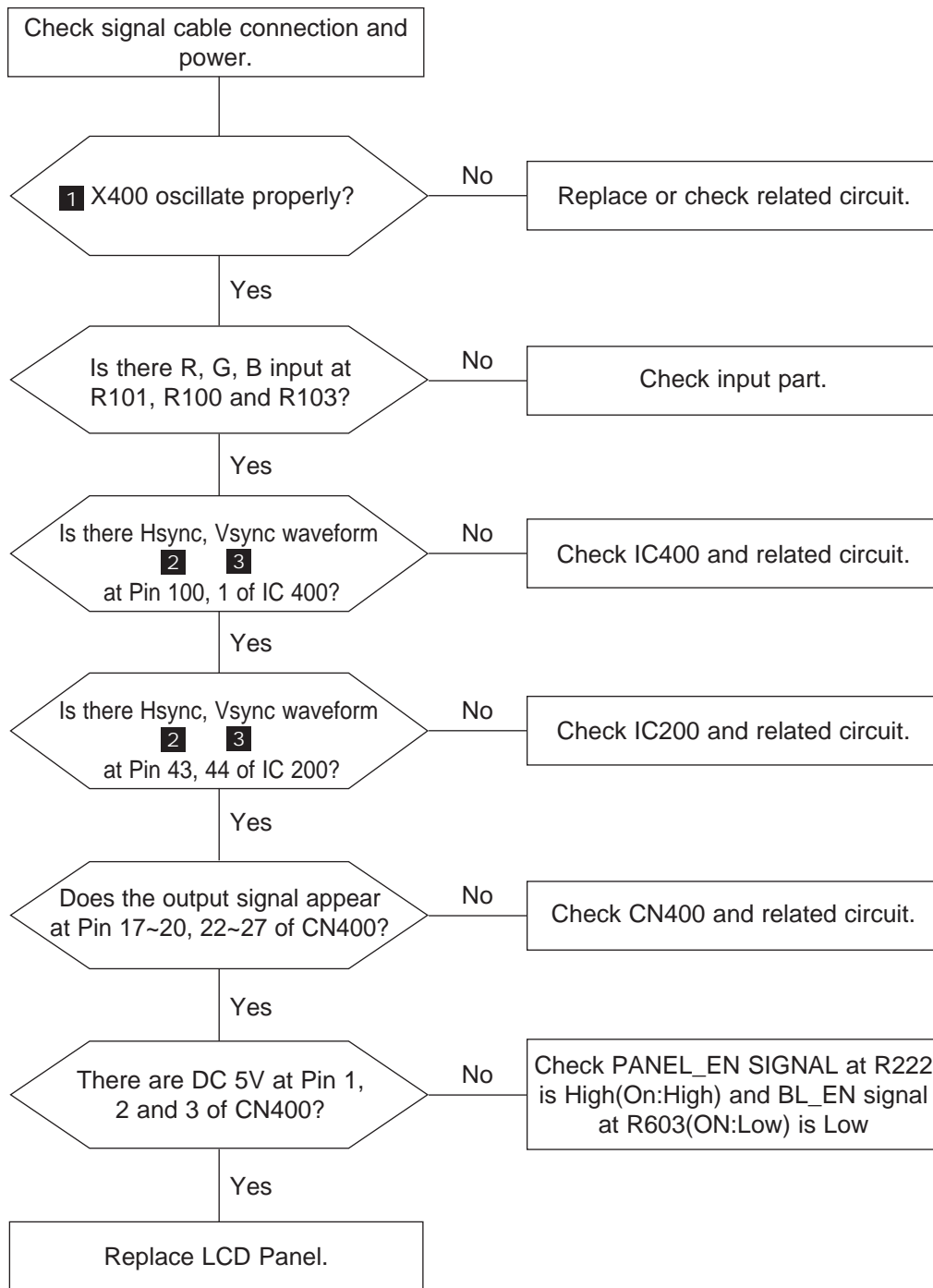

* All locations of this page includes Main PBA.

WAVEFORMS

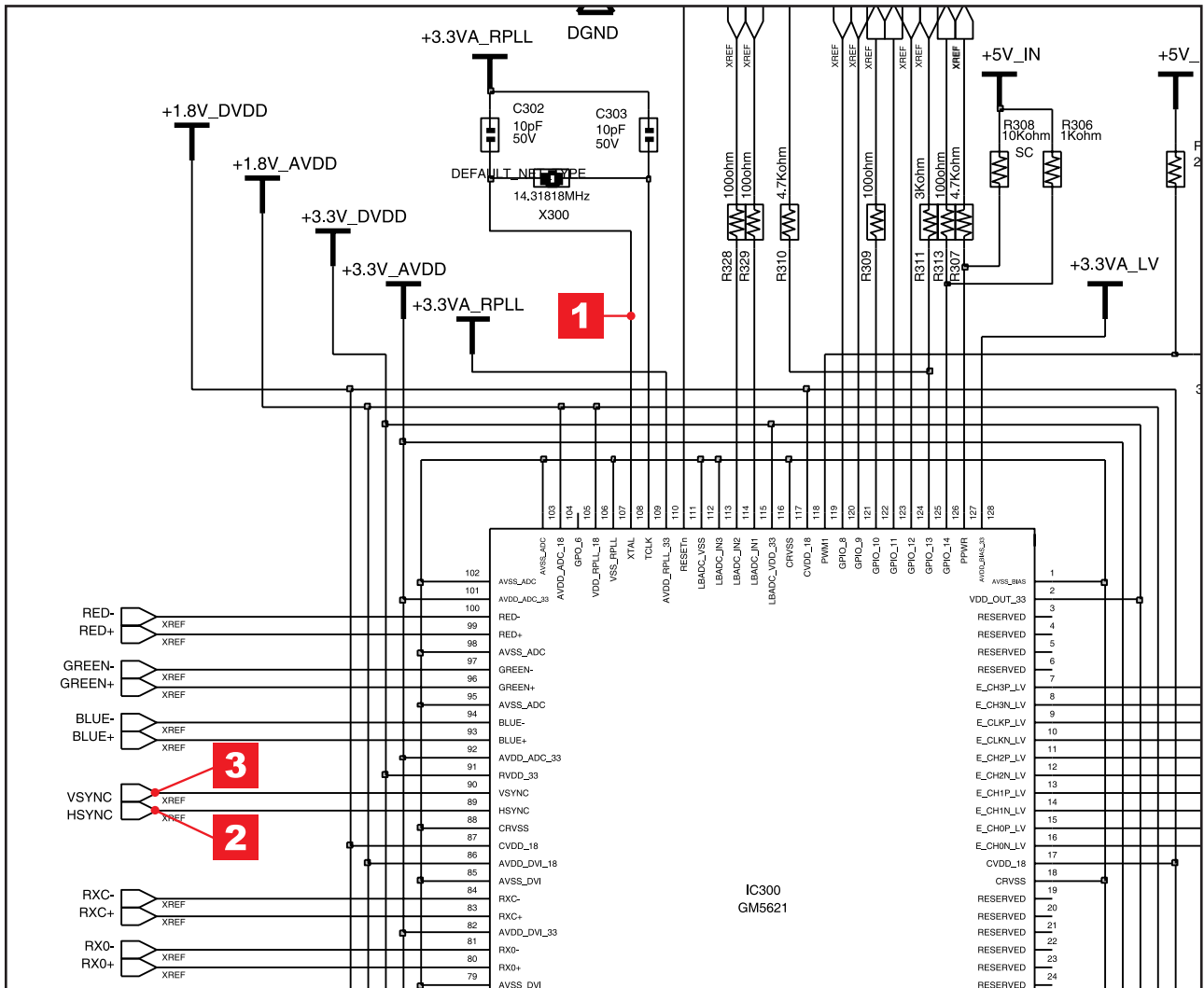
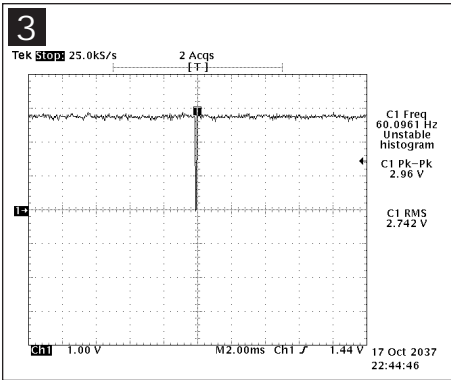
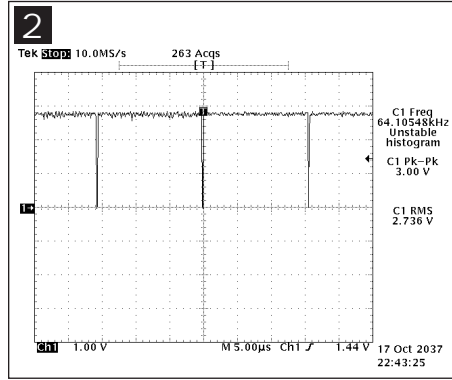
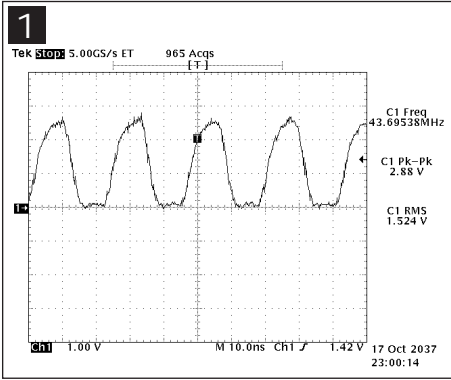

4-3 No Video (DIGITAL 19")

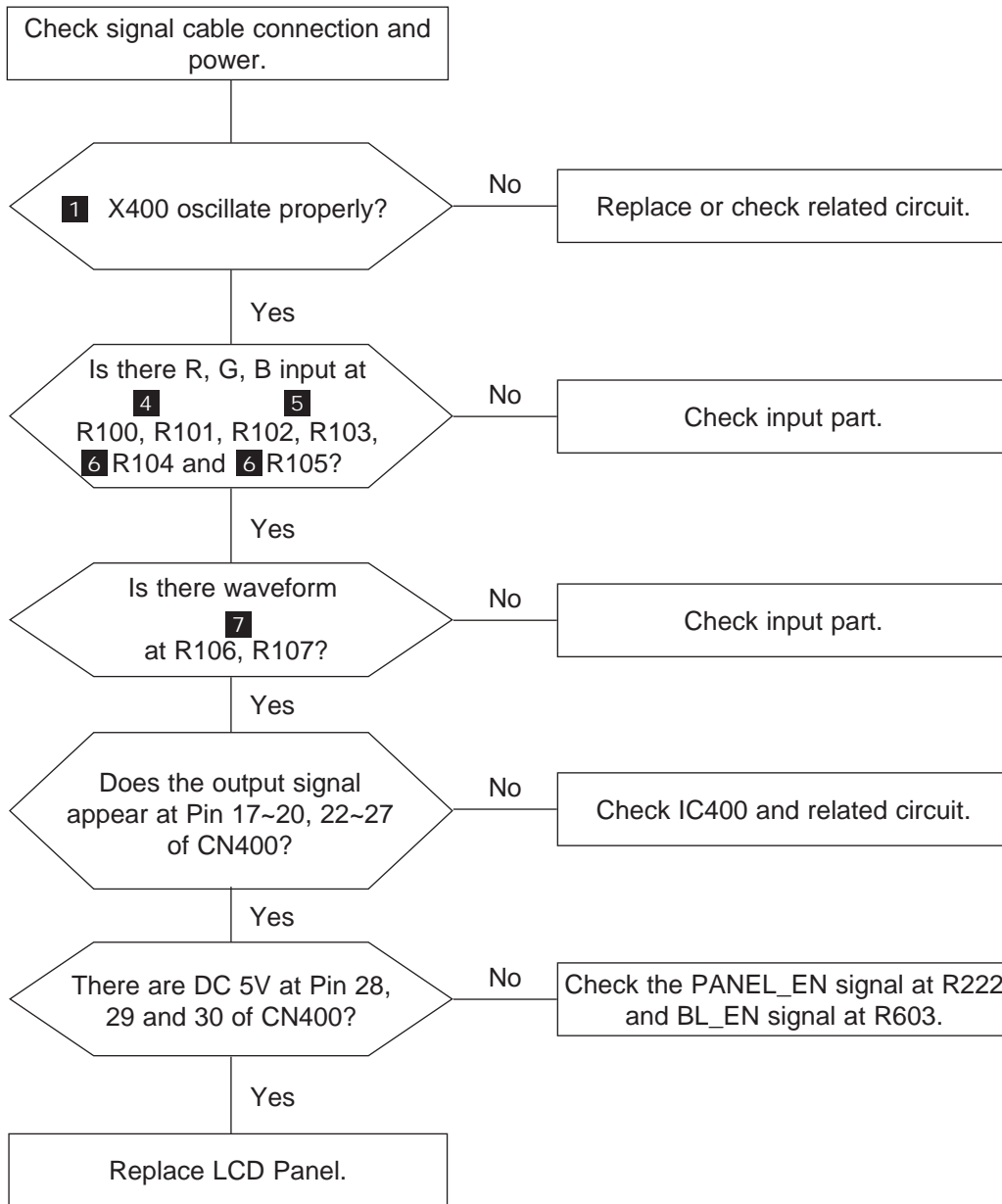

* All locations of this page includes Main PBA.

WAVEFORMS

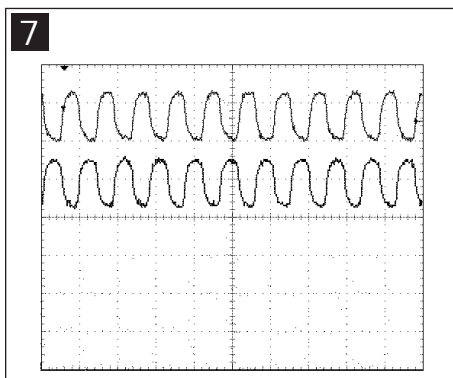
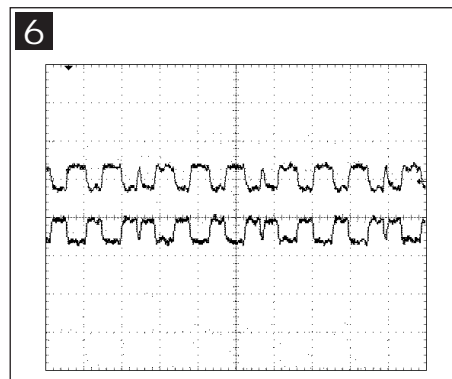
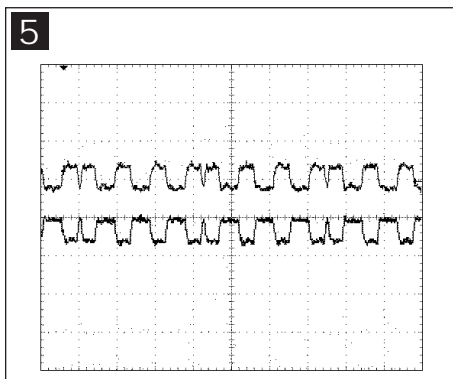
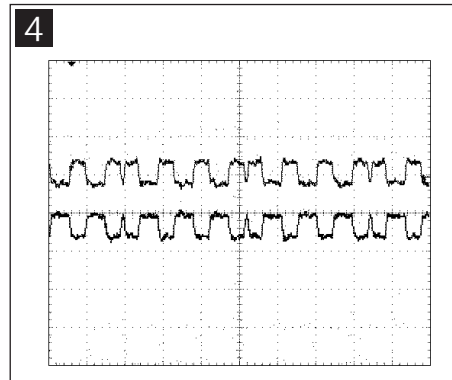
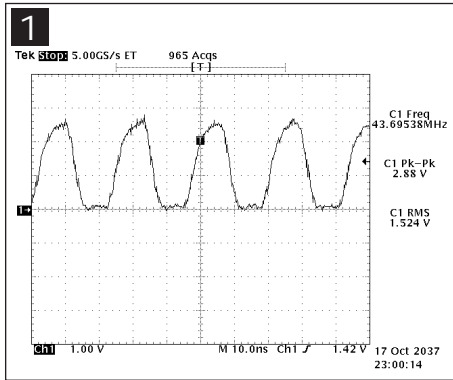

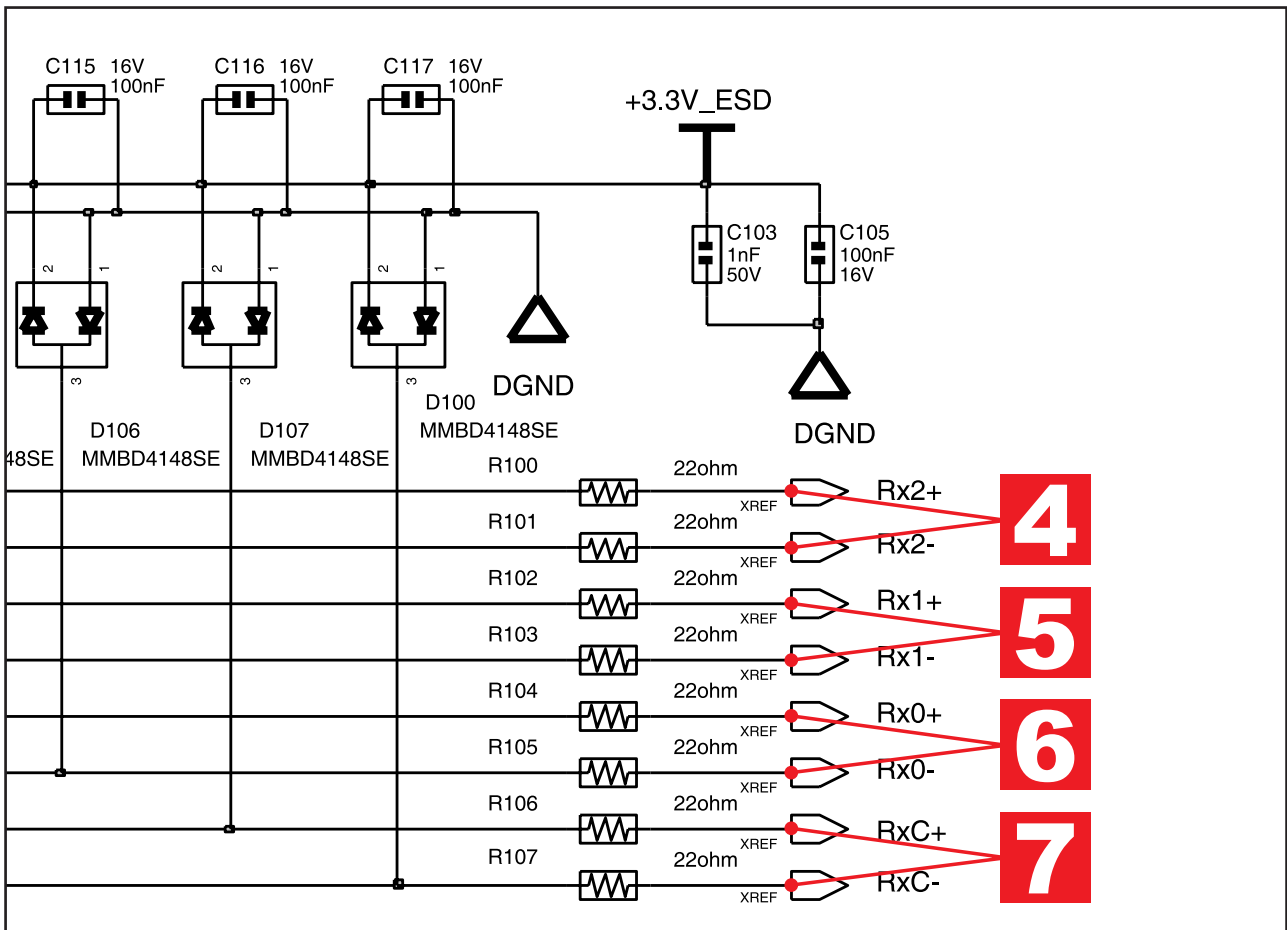

5 Exploded View and Parts List

-You can search for updated part codes through ITSELF web site.

URL : <http://itself.sec.samsung.co.kr>

5-1 LS17PEA Exploded View

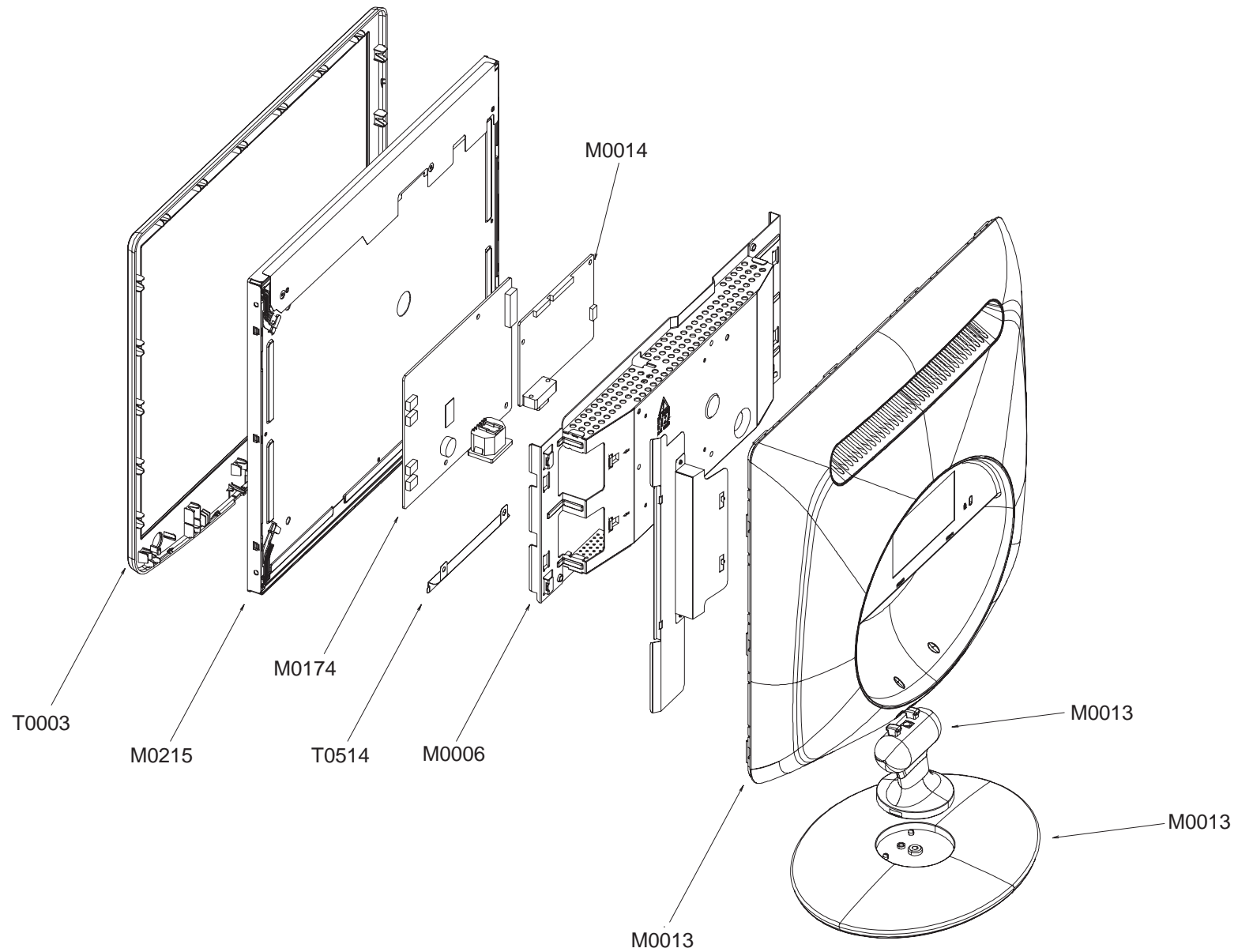

5-2 Parts List

Location	Code.No	Item & Specification	Q'ty	SA/SNA	Remark
T0003	BN96-04140G	ASSY COVER P-FRONT;LS17PE (732N),ABS HB,	1	S.A	
M0215	BN07-00261A	LCD-PANEL;CLAA170ES01,Haydn,6BIT FRC,354	1	S.A	
M0174	BN44-00124E	IP BOARD;IP-35155A(P),Pebble,3.0 ~5.0mA,	1	S.A	
M0014	BN94-01092H	ASSY PCB MAIN-PTZ,W/W;PTZ,W/W	1	S.N.A	
T0514	BN61-02784A	BRACKET-SUPPORT;PEBBLE,SPT,0.3	1	S.N.A	
M0006	BN96-04144A	ASSY SHIELD P-COVER;PEBBLE17,SECC,T0.8	1	S.N.A	
M0013	BN96-04141B	ASSY COVER P-REAR;LS17PE,ABS HB,BK26	1	S.A	
M0013	BN96-04149B	ASSY STAND P-BASE;LS17PE,ABS HB,BK26	1	S.A	
M0013	BN96-04150D	ASSY STAND P-BAR;PEBBLE17,ABS HB,BK26,SF	1	S.A	

5-3 LS19PEB Exploded View

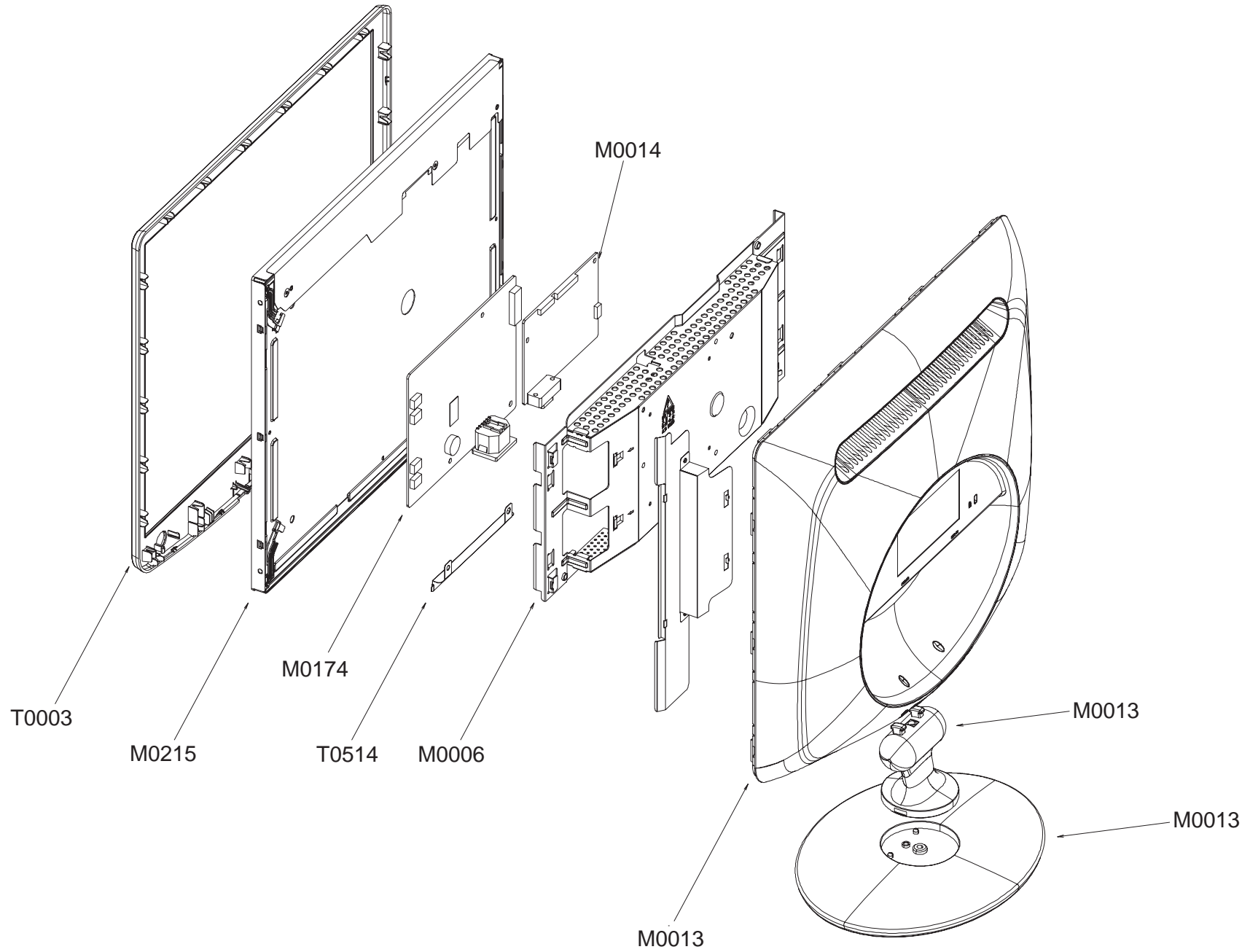

5-4 Parts List

Location	Code.No	Item & Specification	Q'ty	SA/SNA	Remark
T0003	BN96-04142G	ASSY COVER P-FRONT;LS19PE (932B),ABS HB,	1	S.A	
M0215	BN07-00279A	LCD-PANEL;LTM190EX-L31,Haydn,6BIT FRC,39	1	S.A	
M0174	BN44-00124E	IP BOARD;IP-35155A(P),Pebble,3.0 ~5.0mA,	1	S.A	
M0014	BN94-01092B	ASSY PCB MAIN-STZ,W/W;LS19PEB*,SAA4	1	S.N.A	
T0514	BN61-02784A	BRACKET-SUPPORT;PEBBLE,SPTE,0.3	1	S.N.A	
M0006	BN96-04145A	ASSY SHIELD P-COVER;PEBBLE19,SECC,T0.8	1	S.N.A	
M0013	BN96-04143B	ASSY COVER P-REAR;LS19PE,ABS HB,BK26	1	S.A	
M0013	BN96-04154B	ASSY STAND P-BASE;PEBBLE19,ABS HB,BK26	1	S.A	
M0013	BN96-04150D	ASSY STAND P-BAR;PEBBLE17,ABS HB,BK26,SF	1	S.N.A	

6 Electrical Parts List

6-1 LS17PEA Parts List

Level	Loc. No.	Code No.	Description & Specification	Q'ty	SA/SNA	Remark
		LS17PEASB/XBM	732N,SAA4/S17P0-LPE,17,LCD-MO,ECUADOR			
0.1	M0001	BN90-01053B	ASSY COVER FRONT;LS17PEASB/XAX	1	S.N.A	
..2	T0003	BN96-04140G	ASSY COVER P-FRONT;LS17PE (732N),ABS HB,	1	S.A	
...3	M0145	BN96-04363A	ASSY BOARD P-FUNCTION;Pebble,SJ06-01-023	1	S.A	
....4	L0405	0601-001896	LED;SMD,BLUE,1.6x0.8x0.4mm,470,1.6x0.8x0	4	S.A	
....4		2007-000122	R-CHIP;1.2Kohm,5%,1/10W,TP,1608	2	S.A	
....4		2007-000123	R-CHIP;1.5Kohm,5%,1/10W,TP,1608	2	S.A	
....4		2007-001157	R-CHIP;750ohm,5%,1/10W,TP,1608	4	S.A	
....4		2203-000189	C-CER,CHIP;100nF,+80-20%,25V,Y5V,1608	3	S.A	
....4	T0313	3404-000299	SWITCH-TACT;12V,50mA,120gf,6x6x4.3mm,SPS	5	S.A	
....4	T0313	3404-001207	SWITCH-TACT;12V,50mA,160gf,6.2X6.2,SPST	1	S.A	
....4	M2893	BN39-00774A	LEAD CONNECTOR;Pebble,UL1061#28,UL/CSA,3	1	S.A	
....4	M2893	BN39-00788A	LEAD CONNECTOR;Pebble,UL1061#28,4PIN,300	1	S.A	
....4		BN41-00791A	PCB SUB-POWER;Pebble,FR-1,1,1.0,1.6,36*1	1	S.N.A	
....4		BN41-00793B	PCB SUB-FUNCTION;Pebble,FR-1,1,1.1,1.1,1.6,8	1	S.N.A	
...3	M0081	6003-000282	SCREW-TAPTITE;BH,+, -,B,M3,L8,ZPC(BLK),SW	2	S.N.A	
...3		BN61-02828A	GUIDE-PANEL;PEBBLE,SECC,0.5,LS17PEA	1	S.N.A	
...3	CCM1	BN63-02183D	COVER-SHEET;Rhom,PE Vinyl,T0.05,680mm,20	0.45	S.N.A	
...3		BN63-02876B	COVER-FORNT;LS17PE,ABS,2.4,HB,BK26	1	S.N.A	
...3	T0022	BN64-00534B	KNOB CONTROL;PEBBLE,ABS,HB,BK26	1	S.N.A	
...3	T0023	BN64-00597B	KNOB POWER;PEBBLE,black highglossy	1	S.N.A	
...3	M0130	BN67-00193A	LENS LED;PEBBLE,ABS HB,CLR	1	S.N.A	
0.1	M0002	BN90-01054B	ASSY COVER REAR;LS17PEASB/XAX	1	S.N.A	
..2	M0013	BN96-04141B	ASSY COVER P-REAR;LS17PE,ABS HB,BK26	1	S.A	
...3	M0081	6003-001003	SCREW-TAPTITE;BH,+, -,B,M4,L12,ZPC(BLK),SWR	4	S.N.A	
...3	T0060	BN61-02830A	SPRING ETC;PEBBLE,SK5,1.0,LS19PEB,HRC 45	1	S.N.A	
...3	CCM1	BN63-02183D	COVER-SHEET;Rhom,PE Vinyl,T0.05,680mm,20	0.45	S.N.A	
...3	M0006	BN63-02877B	COVER-REAR;LS17PE,ABS,2.6,HB,BK26	1	S.N.A	
...3	M0014	BN63-02880B	COVER-STAND BAR;PEBBLE,ABS PC 5V,2.6,BK2	1	S.N.A	
...3	M0249	BN63-02883B	COVER HINGE;PEBBLE,ABS PC 5V,2.6,BK25	1	S.N.A	
...3	T0102	BN73-00132B	RUBBER-CAP;PEBBLE,ELASTOMER,BK07,HB	1	S.N.A	
0.1	M0135	BN91-01035C	ASSY LCD-PTZ;LS17MED*	1	S.N.A	
..2	M0215	BN07-00261A	LCD-PANEL;CLAA170ES01,Haydn,6BIT FRC,354	1	S.A	
0.1	M0017	BN91-01190H	ASSY CHASSIS-PTZ,W/W;PTZ,W/W	1	S.A	
..2	M0081	6003-000282	SCREW-TAPTITE;BH,+, -,B,M3,L8,ZPC(BLK),SW	1	S.N.A	
..2	M0081	6003-000282	SCREW-TAPTITE;BH,+, -,B,M3,L8,ZPC(BLK),SW	3	S.N.A	
..2	M0081	6003-001439	SCREW-TAPTITE;BH,+, -,S,M4,L8,ZPC(WHT),SW	1	S.N.A	
..2	T0562	6046-001013	STAND OFF;M3,L5,Ni PLT,SUM24L,#4-40	2	S.N.A	
..2	M0174	BN44-00124E	IP BOARD;IP-35155A(P),Pebble,3.0 ~5.0mA,	1	S.A	
..2	T0514	BN61-02784A	BRACKET-SUPPORT;PEBBLE,SPT,0.3	1	S.N.A	
..2	M0014	BN94-01092H	ASSY PCB MAIN-PTZ,W/W;PTZ,W/W	1	S.N.A	
...3	T0245	0202-001492	SOLDER-WIRE FLUX;HSE-02 LFM48 SR-34 S,-,	0.003	S.N.A	
...3	CN101	3701-001219	CONNECTOR-DSUB;15P,3R,FEMALE,ANGLE,AUF	1	S.A	
...3		BN97-01169H	ASSY SMD-PTZ,W/W;PTZ,W/W	1	S.N.A	
....4	SUB05	0202-001477	SOLDER-CREAM;LST309-M,-,D20-45\$,-.96.5Sn/	0.153	S.N.A	

6 Electrical Parts List

Level	Loc. No.	Code No.	Description & Specification	Q'ty	SA/SNA	Remark
....4	D125	0401-001056	DIODE-SWITCHING;MMBD4148SE,100V,200mA,SO	1	S.A	
....4	D126	0401-001056	DIODE-SWITCHING;MMBD4148SE,100V,200mA,SO	1	S.A	
....4	D127	0401-001056	DIODE-SWITCHING;MMBD4148SE,100V,200mA,SO	1	S.A	
....4	D123	0403-001411	DIODE-ZENER;-5.49-5.73V,200mW,SOD-323,T	1	S.A	
....4	D124	0403-001411	DIODE-ZENER;-5.49-5.73V,200mW,SOD-323,T	1	S.A	
....4	D230	0403-001411	DIODE-ZENER;-5.49-5.73V,200mW,SOD-323,T	1	S.A	
....4	D231	0403-001411	DIODE-ZENER;-5.49-5.73V,200mW,SOD-323,T	1	S.A	
....4	D233	0403-001411	DIODE-ZENER;-5.49-5.73V,200mW,SOD-323,T	1	S.A	
....4	D234	0403-001411	DIODE-ZENER;-5.49-5.73V,200mW,SOD-323,T	1	S.A	
....4	D232	0406-001061	DIODE-TVS;MMQA5V6T3,5.32/5.6/5.88V,24W,S	1	S.A	
....4	ZD200	0406-001061	DIODE-TVS;MMQA5V6T3,5.32/5.6/5.88V,24W,S	1	S.A	
....4	Q201	0501-000342	TR-SMALL SIGNAL;KSC1623-Y,NPN,200mW,SOT-	1	S.A	
....4	Q302	0501-002080	TR-SMALL SIGNAL;2SC2412K,NPN,200mW,SC-59	1	S.A	
....4	Q409	0505-001957	FET-SILICON;NTR2101P,P,-8V,-3.7A,0.052oh	1	S.A	
....4	IC112	1103-000129	IC-EEPROM;24C02,2Kbit,256x8Bit,SOP,8P,5x	1	S.A	
....4	IC112	1103-001023	IC-EEPROM;24C08,8Kbit,1Kx8Bit,SOP,8P,5x4	1	S.A	
....4	IC303	1203-001212	IC-VOL. DETECTOR;7029,SOT-89,3P,-,PLASTI	1	S.A	
....4	T0087	1203-003060	IC-POSI.FIXED REG.;AP1084,TO-263,3P,9.97	1	S.A	
....4	T0087	1203-003696	IC-POSI.FIXED REG.;NCP1117DT18T5G,DPAK,3	1	S.A	
....4	IC109	1205-002899	IC-LCD CONTROLLER;GM5726-LF-AA,PQFP,128P	1	S.A	
....4	R316	2007-000070	R-CHIP;0ohm,5%,1/10W,TP,1608	1	S.A	
....4	R129	2007-000071	R-CHIP;22ohm,5%,1/10W,TP,1608	1	S.A	
....4	R130	2007-000071	R-CHIP;22ohm,5%,1/10W,TP,1608	1	S.A	
....4	R125	2007-000074	R-CHIP;100ohm,5%,1/10W,TP,1608	1	S.A	
....4	R126	2007-000074	R-CHIP;100ohm,5%,1/10W,TP,1608	1	S.A	
....4	R134	2007-000074	R-CHIP;100ohm,5%,1/10W,TP,1608	1	S.A	
....4	R136	2007-000074	R-CHIP;100ohm,5%,1/10W,TP,1608	1	S.A	
....4	R138	2007-000074	R-CHIP;100ohm,5%,1/10W,TP,1608	1	S.A	
....4	R142	2007-000074	R-CHIP;100ohm,5%,1/10W,TP,1608	1	S.A	
....4	R143	2007-000074	R-CHIP;100ohm,5%,1/10W,TP,1608	1	S.A	
....4	R144	2007-000074	R-CHIP;100ohm,5%,1/10W,TP,1608	1	S.A	
....4	R212	2007-000074	R-CHIP;100ohm,5%,1/10W,TP,1608	1	S.A	
....4	R213	2007-000074	R-CHIP;100ohm,5%,1/10W,TP,1608	1	S.A	
....4	R233	2007-000074	R-CHIP;100ohm,5%,1/10W,TP,1608	1	S.A	
....4	R234	2007-000074	R-CHIP;100ohm,5%,1/10W,TP,1608	1	S.A	
....4	R309	2007-000074	R-CHIP;100ohm,5%,1/10W,TP,1608	1	S.A	
....4	R313	2007-000074	R-CHIP;100ohm,5%,1/10W,TP,1608	1	S.A	
....4	R328	2007-000074	R-CHIP;100ohm,5%,1/10W,TP,1608	1	S.A	
....4	R329	2007-000074	R-CHIP;100ohm,5%,1/10W,TP,1608	1	S.A	
....4	R333	2007-000074	R-CHIP;100ohm,5%,1/10W,TP,1608	1	S.A	
....4	R604	2007-000074	R-CHIP;100ohm,5%,1/10W,TP,1608	1	S.A	
....4	R306	2007-000078	R-CHIP;1Kohm,5%,1/10W,TP,1608	1	S.A	
....4	R610	2007-000078	R-CHIP;1Kohm,5%,1/10W,TP,1608	1	S.A	
....4	R128	2007-000080	R-CHIP;2Kohm,5%,1/10W,TP,1608	1	S.A	
....4	R201	2007-000082	R-CHIP;3.3Kohm,5%,1/10W,TP,1608	1	S.A	
....4	R202	2007-000082	R-CHIP;3.3Kohm,5%,1/10W,TP,1608	1	S.A	
....4	R311	2007-000083	R-CHIP;3Kohm,5%,1/10W,TP,1608	1	S.A	
....4	R330	2007-000083	R-CHIP;3Kohm,5%,1/10W,TP,1608	1	S.A	
....4	R331	2007-000083	R-CHIP;3Kohm,5%,1/10W,TP,1608	1	S.A	
....4	R300	2007-000084	R-CHIP;4.7Kohm,5%,1/10W,TP,1608	1	S.A	
....4	R307	2007-000084	R-CHIP;4.7Kohm,5%,1/10W,TP,1608	1	S.A	
....4	R310	2007-000084	R-CHIP;4.7Kohm,5%,1/10W,TP,1608	1	S.A	

Level	Loc. No.	Code No.	Description & Specification	Q'ty	SA/SNA	Remark
....4	R318	2007-000084	R-CHIP;4.7Kohm,5%,1/10W,TP,1608	1	SA	
....4	R319	2007-000084	R-CHIP;4.7Kohm,5%,1/10W,TP,1608	1	SA	
....4	R320	2007-000084	R-CHIP;4.7Kohm,5%,1/10W,TP,1608	1	SA	
....4	R321	2007-000084	R-CHIP;4.7Kohm,5%,1/10W,TP,1608	1	SA	
....4	R325	2007-000084	R-CHIP;4.7Kohm,5%,1/10W,TP,1608	1	SA	
....4	R326	2007-000084	R-CHIP;4.7Kohm,5%,1/10W,TP,1608	1	SA	
....4	R327	2007-000084	R-CHIP;4.7Kohm,5%,1/10W,TP,1608	1	SA	
....4	R127	2007-000090	R-CHIP;10Kohm,5%,1/10W,TP,1608	1	SA	
....4	R230	2007-000090	R-CHIP;10Kohm,5%,1/10W,TP,1608	1	SA	
....4	R231	2007-000090	R-CHIP;10Kohm,5%,1/10W,TP,1608	1	SA	
....4	R232	2007-000090	R-CHIP;10Kohm,5%,1/10W,TP,1608	1	SA	
....4	R301	2007-000090	R-CHIP;10Kohm,5%,1/10W,TP,1608	1	SA	
....4	R304	2007-000090	R-CHIP;10Kohm,5%,1/10W,TP,1608	1	SA	
....4	R305	2007-000090	R-CHIP;10Kohm,5%,1/10W,TP,1608	1	SA	
....4	R308	2007-000090	R-CHIP;10Kohm,5%,1/10W,TP,1608	1	SA	
....4	R315	2007-000090	R-CHIP;10Kohm,5%,1/10W,TP,1608	1	SA	
....4	R323	2007-000090	R-CHIP;10Kohm,5%,1/10W,TP,1608	1	SA	
....4	R324	2007-000090	R-CHIP;10Kohm,5%,1/10W,TP,1608	1	SA	
....4	R210	2007-000092	R-CHIP;15Kohm,5%,1/10W,TP,1608	1	SA	
....4	R211	2007-000092	R-CHIP;15Kohm,5%,1/10W,TP,1608	1	SA	
....4	R214	2007-000092	R-CHIP;15Kohm,5%,1/10W,TP,1608	1	SA	
....4	R302	2007-000102	R-CHIP;100Kohm,5%,1/10W,TP,1608	1	SA	
....4	R303	2007-000124	R-CHIP;2.2Kohm,5%,1/10W,TP,1608	1	SA	
....4	R314	2007-000608	R-CHIP;240ohm,5%,1/10W,TP,1608	1	SA	
....4	R145	2007-001164	R-CHIP;75ohm,1%,1/10W,TP,1608	1	SA	
....4	R146	2007-001164	R-CHIP;75ohm,1%,1/10W,TP,1608	1	SA	
....4	R147	2007-001164	R-CHIP;75ohm,1%,1/10W,TP,1608	1	SA	
....4	C302	2203-000041	C-CER,CHIP;0.01nF,0.25pF,50V,C0G,1608	1	SA	
....4	C303	2203-000041	C-CER,CHIP;0.01nF,0.25pF,50V,C0G,1608	1	SA	
....4	C203	2203-000189	C-CER,CHIP;100nF,+80-20%,25V,Y5V,1608	1	SA	
....4	C126	2203-000257	C-CER,CHIP;10nF,10%,50V,X7R,1608	1	SA	
....4	C127	2203-000257	C-CER,CHIP;10nF,10%,50V,X7R,1608	1	SA	
....4	C128	2203-000257	C-CER,CHIP;10nF,10%,50V,X7R,1608	1	SA	
....4	C129	2203-000257	C-CER,CHIP;10nF,10%,50V,X7R,1608	1	SA	
....4	C130	2203-000257	C-CER,CHIP;10nF,10%,50V,X7R,1608	1	SA	
....4	C131	2203-000257	C-CER,CHIP;10nF,10%,50V,X7R,1608	1	SA	
....4	C201	2203-000257	C-CER,CHIP;10nF,10%,50V,X7R,1608	1	SA	
....4	C202	2203-000257	C-CER,CHIP;10nF,10%,50V,X7R,1608	1	SA	
....4	C300	2203-000257	C-CER,CHIP;10nF,10%,50V,X7R,1608	1	SA	
....4	C140	2203-000872	C-CER,CHIP;0.0030nF,0.25pF,50V,C0G,1608	1	SA	
....4	C141	2203-000872	C-CER,CHIP;0.0030nF,0.25pF,50V,C0G,1608	1	SA	
....4	C142	2203-000872	C-CER,CHIP;0.0030nF,0.25pF,50V,C0G,1608	1	SA	
....4	C607	2203-001652	C-CER,CHIP;470nF,+80-20%,16V,Y5V,1608	1	SA	
....4	C112	2203-005005	C-CER,CHIP;100nF,10%,16V,X7R,1608	1	SA	
....4	C113	2203-005005	C-CER,CHIP;100nF,10%,16V,X7R,1608	1	SA	
....4	C123	2203-005005	C-CER,CHIP;100nF,10%,16V,X7R,1608	1	SA	
....4	C210	2203-005005	C-CER,CHIP;100nF,10%,16V,X7R,1608	1	SA	
....4	C230	2203-005005	C-CER,CHIP;100nF,10%,16V,X7R,1608	1	SA	
....4	C307	2203-005005	C-CER,CHIP;100nF,10%,16V,X7R,1608	1	SA	
....4	C308	2203-005005	C-CER,CHIP;100nF,10%,16V,X7R,1608	1	SA	
....4	C310	2203-005005	C-CER,CHIP;100nF,10%,16V,X7R,1608	1	SA	
....4	C610	2203-005005	C-CER,CHIP;100nF,10%,16V,X7R,1608	1	SA	

6 Electrical Parts List

Level	Loc. No.	Code No.	Description & Specification	Q'ty	SA/SNA	Remark
....4	C611	2203-005005	C-CER,CHIP;100nF,10%,16V,X7R,1608	1	S.A	
....4	C615	2203-005005	C-CER,CHIP;100nF,10%,16V,X7R,1608	1	S.A	
....4	C616	2203-005005	C-CER,CHIP;100nF,10%,16V,X7R,1608	1	S.A	
....4	C617	2203-005005	C-CER,CHIP;100nF,10%,16V,X7R,1608	1	S.A	
....4	C618	2203-005005	C-CER,CHIP;100nF,10%,16V,X7R,1608	1	S.A	
....4	C619	2203-005005	C-CER,CHIP;100nF,10%,16V,X7R,1608	1	S.A	
....4	C620	2203-005005	C-CER,CHIP;100nF,10%,16V,X7R,1608	1	S.A	
....4	C622	2203-005005	C-CER,CHIP;100nF,10%,16V,X7R,1608	1	S.A	
....4	C623	2203-005005	C-CER,CHIP;100nF,10%,16V,X7R,1608	1	S.A	
....4	C624	2203-005005	C-CER,CHIP;100nF,10%,16V,X7R,1608	1	S.A	
....4	C625	2203-005005	C-CER,CHIP;100nF,10%,16V,X7R,1608	1	S.A	
....4	C635	2203-005005	C-CER,CHIP;100nF,10%,16V,X7R,1608	1	S.A	
....4	C636	2203-005005	C-CER,CHIP;100nF,10%,16V,X7R,1608	1	S.A	
....4	C638	2203-005005	C-CER,CHIP;100nF,10%,16V,X7R,1608	1	S.A	
....4	C639	2203-005005	C-CER,CHIP;100nF,10%,16V,X7R,1608	1	S.A	
....4	C641	2203-005005	C-CER,CHIP;100nF,10%,16V,X7R,1608	1	S.A	
....4	C642	2203-005005	C-CER,CHIP;100nF,10%,16V,X7R,1608	1	S.A	
....4	C643	2203-005005	C-CER,CHIP;100nF,10%,16V,X7R,1608	1	S.A	
....4	C648	2203-005005	C-CER,CHIP;100nF,10%,16V,X7R,1608	1	S.A	
....4	C649	2203-005005	C-CER,CHIP;100nF,10%,16V,X7R,1608	1	S.A	
....4	C650	2203-005005	C-CER,CHIP;100nF,10%,16V,X7R,1608	1	S.A	
....4	C651	2203-005005	C-CER,CHIP;100nF,10%,16V,X7R,1608	1	S.A	
....4	C652	2203-005005	C-CER,CHIP;100nF,10%,16V,X7R,1608	1	S.A	
....4	C653	2203-005005	C-CER,CHIP;100nF,10%,16V,X7R,1608	1	S.A	
....4	C677	2203-005005	C-CER,CHIP;100nF,10%,16V,X7R,1608	1	S.A	
....4	C304	2203-005065	C-CER,CHIP;1000nF,+80-20%,10V,Y5V,1608	1	S.A	
....4	C305	2203-005065	C-CER,CHIP;1000nF,+80-20%,10V,Y5V,1608	1	S.A	
....4	C309	2203-005065	C-CER,CHIP;1000nF,+80-20%,10V,Y5V,1608	1	S.A	
....4	C311	2203-005065	C-CER,CHIP;1000nF,+80-20%,10V,Y5V,1608	1	S.A	
....4	C312	2203-005065	C-CER,CHIP;1000nF,+80-20%,10V,Y5V,1608	1	S.A	
....4	C614	2203-005437	C-CER,CHIP;10000nF,+80-20%,10V,Y5V,3216	1	S.A	
....4	C621	2203-005437	C-CER,CHIP;10000nF,+80-20%,10V,Y5V,3216	1	S.A	
....4	C634	2203-005437	C-CER,CHIP;10000nF,+80-20%,10V,Y5V,3216	1	S.A	
....4	C637	2203-005437	C-CER,CHIP;10000nF,+80-20%,10V,Y5V,3216	1	S.A	
....4	C306	2402-001128	C-AL,SMD;100#IF,20%,16V,-,TP,6.3X5.7mm	1	S.A	
....4	C608	2402-001128	C-AL,SMD;100#IF,20%,16V,-,TP,6.3X5.7mm	1	S.A	
....4	C609	2402-001128	C-AL,SMD;100#IF,20%,16V,-,TP,6.3X5.7mm	1	S.A	
....4	C644	2402-001128	C-AL,SMD;100#IF,20%,16V,-,TP,6.3X5.7mm	1	S.A	
....4	X300	2801-003667	CRYSTAL-SMD;14.31818MHz,30ppm,28-AAN,16,	1	S.A	
....4	T0568	3301-001145	BEAD-SMD;60ohm,4516,TP,70ohm/45MHz,82ohm	1	S.N.A	
....4	T0568	3301-001145	BEAD-SMD;60ohm,4516,TP,70ohm/45MHz,82ohm	1	S.N.A	
....4	T0568	3301-001145	BEAD-SMD;60ohm,4516,TP,70ohm/45MHz,82ohm	1	S.N.A	
....4	T0568	3301-001145	BEAD-SMD;60ohm,4516,TP,70ohm/45MHz,82ohm	1	S.N.A	
....4	T0568	3301-001145	BEAD-SMD;60ohm,4516,TP,70ohm/45MHz,82ohm	1	S.N.A	
....4	T0568	3301-001145	BEAD-SMD;60ohm,4516,TP,70ohm/45MHz,82ohm	1	S.N.A	
....4	T0568	3301-001145	BEAD-SMD;60ohm,4516,TP,70ohm/45MHz,82ohm	1	S.N.A	
....4	T0568	3301-001145	BEAD-SMD;60ohm,4516,TP,70ohm/45MHz,82ohm	1	S.N.A	
....4	T0568	3301-001145	BEAD-SMD;60ohm,4516,TP,70ohm/45MHz,82ohm	1	S.N.A	
....4	CN400	3708-001150	CONNECTOR-FPC/FFC/PIC;30P,1mm,SMD-A,SN,Y	1	S.A	
....4	CN330	3711-005503	HEADER-BOARD TO CABLE;BOX,9P,1R,2mm,SMD-	1	S.A	
....4	CN330	3711-005509	HEADER-BOARD TO CABLE;BOX,4P,1R,1.25mm,S	1	S.A	
....4	T0077	BN41-00795A	PCB MAIN;LS17PEA,Silver through,2,MP1.0,	1	S.N.A	

Level	Loc. No.	Code No.	Description & Specification	Q'ty	SA/SNA	Remark
....4	M0018	BN97-01309A	ASSY MICOM;M-PE17A9Bla-1000,LS17PEASW/ED	1	S.A	
....5	IC115	1107-001561	IC-FLASH MEMORY;25VF010,128Kx8Bit,SOP,8P	1	S.N.A	
..2	M2893	BN96-02854J	ASSY MISC P-FFC CABLE;Haydn RTA Refresh	1	S.A	
..2	M0006	BN96-04144A	ASSY SHIELD P-COVER;PEBBLE17,SECC,T0.8	1	S.N.A	
...3		BN61-02429D	STUD-PEM;PNB,M2.8,D7,L20,ZPC(SIL),SUM24L	1	S.N.A	
...3	M0107	BN63-02884A	SHIELD-COVER;PEBBLE,SECC,0.8,17INCH	1	S.N.A	
...3	M0114	BP61-01088A	HOLDER-WIRE;SVP-42L6,NYLON	1	S.N.A	
...3	M0131	AA63-01240A	GASKET;FIRENZE,Conductive Fabric,3mm,12m	2	S.N.A	
..2	M0524	BP39-00028A	CONNECT WIRE;BI17,19BS,UL1007#26,9P,80mm	1	S.A	
0.1	M0112	BN91-01211A	ASSY SHIELD;LS17PEASW/EDC	1	S.N.A	
..2		BN63-02885A	SHIELD-LAMP;PEBBLE,SPTe,0.3,17INCH	1	S.N.A	
0.1	M0019	BN92-02024K	ASSY LABEL;LS17PEASB/CLT	1	S.N.A	
0.1	M0113	BN92-02029A	ASSY P/MATERIAL;LS17PEA*,SAA4,PEBBLE	1	S.N.A	
..2	T0376	6902-000061	BAG AIR;LDPE,T0.2,L1000,W500,TRP,,,	0.003	S.N.A	
..2	T0376	6902-000379	BAG AIR;LDPE,T0.2,W1000,L1800,TRP,-,-	0.001	S.N.A	
..2	T0524	6902-000561	BAG PE;HDPE+NITRON(DOUBLE),T0.015+T0.5,W	1	S.N.A	
..2	T0003	6902-000604	BAG WRAPPING;LDPE,T0.02,W500,L10000,TRP,	0.52	S.N.A	
..2	M0081	6902-000609	BAG ROLL;LDPE,T0.05,W2400,L1000,TRP,-,-	0.02	S.N.A	
0.1	M0003	BN92-02030J	ASSY BOX;LS17PEASW/XST	1	S.N.A	
..2	BOX	BN69-01530A	BOX-SET;LS17PB,SY-01,A,YEL,A-01,W426,D36	1.01	S.N.A	
..2	T0081	BN96-02895A	ASSY MISC P-HANDLE PACKING;ALL MODEL,BN6	1	S.N.A	
...3	M0103	BN66-00007A	LEVER-TOP;ALL MODEL,LDPE,WHITE	1	S.N.A	
...3	M0102	BN66-00008A	LEVER-BOTTOM;ALL MODEL,LDPE,WHITE	1	S.N.A	
0.1	M0045	BN92-02221B	ASSY ACCESSORY;LS17PEASB/XBM	1	S.N.A	
..2	M0114	BN39-00244B	CBF SIGNAL;M015PS,15P/15P,20276-N,1830mm	1	S.A	
..2	M0013	BN96-04149B	ASSY STAND P-BASE;LS17PE,ABS HB,BK26	1	S.A	
...3	T0524	6902-000118	BAG PE;HDPE/NITRON,T0.02/T0.5,W210,L320,	1	S.N.A	
...3	CIS4	BN61-01717A	HOLDER-STAND;BIZET,NI PLT,CH,+,M4,L11(5)	1	S.A	
...3	CCM1	BN63-02183C	COVER-SHEET;Rhom,PE Vinyl,T0.05,200mm,20	0.3	S.N.A	
...3	T0004	BN63-02881B	COVER-STAND BASE;LS17PE,ABS,2.6,HB,BK26	1	S.N.A	
...3		BN68-01115A	MANUAL FLYER-QSG;COMM,SyncMaster,korean,	1	S.N.A	
...3	T0132	BN73-00077A	RUBBER FOOT;MATISSE,BUMPON,³13.5,T2.0,6	4	S.N.A	
..2	M0045	BN96-04279N	ASSY ACCESSORY;LS19PEBSBV/XBM	1	S.A	
...3	T0268	3903-000085	CBF-POWER CORD;DT,US,BP3/YES,I(IEC C13/C	1	S.A	
...3	T0524	6902-000110	BAG PE;LDPE,T0.05,W250,L400,TRP,28,2	1	S.N.A	
...3	ACCESSORY	AA68-03727A	MANUAL FLYER-01,WARRANTY CARD;All,SAMSUN	1	S.N.A	
...3	ACCESSORY	BN63-02368A	CLOTH;LS07BTT,SUEDE,0.6,160,120	1	S.N.A	
...3	M0215	BN96-04304A	ASSY MANUAL P-IB+QSG;932B,732N,SyncMaste	1	S.N.A	
....4	QSG	BH68-00376L	MANUAL FLYER-04,QSG;LCDQUICK SETUP GUIDE	1	S.N.A	
....4	IB	BN59-00585A	S/W DRIVER-01,IB;932B,732N,W/W,SyncMaste	1	S.N.A	
..2		BN68-01115C	MANUAL FLYER-QSG;COMM,SyncMaster,korean,	1	S.N.A	
..2	M0013	BN96-04150D	ASSY STAND P-BAR;PEBBLE17,ABS HB,BK26,SF	1	S.A	
...3	M0081	6003-000282	SCREW-TAPTITE;BH,+,-,B,M3,L8,ZPC(BLK),SW	2	S.N.A	
...3	T0524	6902-000023	BAG PE;LDPE,T0.08,L120,W150,TRP,,PE MAR	1	S.N.A	
...3		BN61-02783D	STAND-BAR;PEBBLE,ABS HB,SL-414WH,BK26,SF	1	S.N.A	
...3		BN61-02786A	BRACKET-PLATE;PEBBLE,SECC,1.0	1	S.N.A	

6 Electrical Parts List

6-2 LS19PEB Parts List

Level	Loc. No.	Code No.	Description & Specification	Q'ty	SA/SNA	Remark
		LS19PEBSW/EDC	932B,SAB3/S19P0-LPE,19,LCD-MO,NETHERLAND			
0.1	M0001	BN90-01055A	ASSY COVER FRONT;LS19PEBSW/EDC	1	S.N.A	
..2	T0003	BN63-04142A	ASSY COVER P-FRONT;LS19PE (932B),ABS HB,	1	S.A	
...3	M0112	BN63-02878A	COVER-FRONT;PEBBLE,ABS HB,2.4,WH13,SF050	1	S.N.A	
...3	T0023	BN64-00533A	KNOB POWER;PEBBLE,WH12,TPU,HB	1	S.N.A	
...3	T0022	BN64-00534A	KNOB CONTROL;PEBBLE,ABS,HB,WH13,SF-0500	1	S.N.A	
...3	M0145	BN96-04363A	ASSY BOARD P-FUCNTION;Pebble,SJ06-01-023	1	S.A	
...3	M0081	6003-000282	SCREW-TAPTITE;BH,+,-,B,M3,L8,ZPC(BLK),SW	2	S.N.A	
...3		BN61-02829A	GUIDE-PANEL;PEBBLE,SECC,0.5,LS19PEB	1	S.N.A	
...3	CCM1	BN63-02183D	COVER-SHEET;RhcM,PE Vinyl,TO.05,680mm,20	0.45	S.N.A	
0.1	M0002	BN90-01056A	ASSY COVER REAR;LS19PEBSW/EDC	1	S.N.A	
..2	M0013	BN96-04143A	ASSY COVER P-REAR;LS19PE,ABS HB,WH13,SF-	1	S.A	
...3	M0081	6003-001003	SCREW-TAPTITE;BH,+,-,B,M4,L12,ZPC(BLK),SWR	4	S.N.A	
...3	M0006	BN63-02879A	COVER-REAR;PEBBLE,ABS HB,2.6,WH13,SF0500	1	S.N.A	
...3	M0014	BN63-02880A	COVER-STAND BAR;PEBBLE,ABS PC,2.6,WH12	1	S.N.A	
...3	M0249	BN63-02883A	COVER HINGE;PEBBLE,ABS PC,2.5,WH12	1	S.N.A	
...3	M0126	BN73-00096A	RUBBER-PANEL;B19BS,RUBBER,T1.0,50-60,NT	2	S.N.A	
...3	T0102	BN73-00132A	RUBBER-CAP;PEBBLE,ELASTOMER,TPE,HB,IV16	1	S.N.A	
...3	T0060	BN61-02830A	SPRING ETC;PEBBLE,SK5,1.0,LS19PEB,HRC 45	1	S.N.A	
...3	CCM1	BN63-02183D	COVER-SHEET;RhcM,PE Vinyl,TO.05,680mm,20	0.45	S.N.A	
0.1	M0106	BN91-00939Z	ASSY LCD-STZ;ME19DS*	1	S.N.A	
..2	M0215	BN07-00279A	LCD-PANEL;LTM190EX-L31,Haydn,6BIT FRC,39	1	S.A	
0.1	M0017	BN91-01190B	ASSY CHASSIS-STZ,W/W;LS19PEBSW/EDC,SAA4	1	S.A	
..2	M0081	6003-000282	SCREW-TAPTITE;BH,+,-,B,M3,L8,ZPC(BLK),SW	1	S.N.A	
..2	M0081	6003-000282	SCREW-TAPTITE;BH,+,-,B,M3,L8,ZPC(BLK),SW	3	S.N.A	
..2	M0081	6003-001439	SCREW-TAPTITE;BH,+,-,S,M4,L8,ZPC(YEL)	1	S.N.A	
..2	T0514	BN61-02784A	BRACKET-SUPPORT;PEBBLE,SPTPE,0.3	1	S.N.A	
..2	M0014	BN94-01092B	ASSY PCB MAIN-STZ,W/W;LS19PEB*,SAA4	1	S.N.A	
...3	T0245	0202-001492	SOLDER-WIRE FLUX;HSE-02 LFM48 SR-34 S,-,	0.003	S.N.A	
...3	CN102	3701-001173	CONNECTOR-DVI;24P,3R,FEMALE,ANGLE,AUF	1	S.A	
...3	CN101	3701-001219	CONNECTOR-DSUB;15P,3R,FEMALE,ANGLE,AUF	1	S.A	
...3	T0510	BN97-01169B	ASSY SMD-MAIN;LS19PEBSW/EDC,SAA4	1	S.N.A	
...4	SUB05	0202-001477	SOLDER-CREAM;LST309-M,-,D20-45\$,96.5Sn/	0.178	S.N.A	
....4	D100	0401-001056	DIODE-SWITCHING;MMBD4148SE,100V,200mA,SO	1	S.A	
....4	D101	0401-001056	DIODE-SWITCHING;MMBD4148SE,100V,200mA,SO	1	S.A	
....4	D102	0401-001056	DIODE-SWITCHING;MMBD4148SE,100V,200mA,SO	1	S.A	
....4	D103	0401-001056	DIODE-SWITCHING;MMBD4148SE,100V,200mA,SO	1	S.A	
....4	D104	0401-001056	DIODE-SWITCHING;MMBD4148SE,100V,200mA,SO	1	S.A	
....4	D105	0401-001056	DIODE-SWITCHING;MMBD4148SE,100V,200mA,SO	1	S.A	
....4	D106	0401-001056	DIODE-SWITCHING;MMBD4148SE,100V,200mA,SO	1	S.A	
....4	D107	0401-001056	DIODE-SWITCHING;MMBD4148SE,100V,200mA,SO	1	S.A	
....4	D108	0401-001056	DIODE-SWITCHING;MMBD4148SE,100V,200mA,SO	1	S.A	
....4	D110	0401-001056	DIODE-SWITCHING;MMBD4148SE,100V,200mA,SO	1	S.A	
....4	D125	0401-001056	DIODE-SWITCHING;MMBD4148SE,100V,200mA,SO	1	S.A	
....4	D126	0401-001056	DIODE-SWITCHING;MMBD4148SE,100V,200mA,SO	1	S.A	
....4	D127	0401-001056	DIODE-SWITCHING;MMBD4148SE,100V,200mA,SO	1	S.A	
....4	D109	0403-001411	DIODE-ZENER;-5.49-5.73V,200mW,SOD-323,T	1	S.A	
....4	D123	0403-001411	DIODE-ZENER;-5.49-5.73V,200mW,SOD-323,T	1	S.A	
....4	D124	0403-001411	DIODE-ZENER;-5.49-5.73V,200mW,SOD-323,T	1	S.A	
....4	D128	0403-001411	DIODE-ZENER;-5.49-5.73V,200mW,SOD-323,T	1	S.A	
....4	D129	0403-001411	DIODE-ZENER;-5.49-5.73V,200mW,SOD-323,T	1	S.A	
....4	D220	0403-001411	DIODE-ZENER;-5.49-5.73V,200mW,SOD-323,T	1	S.A	
....4	D230	0403-001411	DIODE-ZENER;-5.49-5.73V,200mW,SOD-323,T	1	S.A	
....4	D231	0403-001411	DIODE-ZENER;-5.49-5.73V,200mW,SOD-323,T	1	S.A	
....4	D221	0406-001061	DIODE-TVS;MMQA5V6T3,5.32/5.6/5.88V,24W,S	1	S.A	
....4	D232	0406-001061	DIODE-TVS;MMQA5V6T3,5.32/5.6/5.88V,24W,S	1	S.A	
....4	ZD200	0406-001061	DIODE-TVS;MMQA5V6T3,5.32/5.6/5.88V,24W,S	1	S.A	

Level	Loc. No.	Code No.	Description & Specification	Q'ty	SA/SNA	Remark
....4	Q201	0501-000342	TR-SMALL SIGNAL;KSC1623-Y,NPN,200mW,SOT-	1	S.A	
....4	Q302	0501-002080	TR-SMALL SIGNAL;2SC2412K,NPN,200mW,SC-59	1	S.A	
....4	Q409	0505-001957	FET-SILICON;NTR2101P,P,-8V,-3.7A,0.052oh	1	S.A	
....4	IC112	1103-000129	IC-EEPROM;24C02,2Kbit,256x8Bit,SOP,8P,5x	1	S.A	
....4	IC112	1103-000129	IC-EEPROM;24C02,2Kbit,256x8Bit,SOP,8P,5x	1	S.A	
....4	IC112	1103-001023	IC-EEPROM;24C08,8Kbit,1Kx8Bit,SOP,8P,5x4	1	S.A	
....4	IC303	1203-001212	IC-VOL. DETECTOR;7029,SOT-89,3P,-,PLASTI	1	S.A	
....4	T0087	1203-003060	IC-POSI.FIXED REG.;AP1084,TO-263,3P,9.97	1	S.A	
....4	T0087	1203-003696	IC-POSI.FIXED REG.;NCP1117DT18T5G,DPAK,3	1	S.A	
....4	IC109	1205-002899	IC-LCD CONTROLLER;GM5726-LF-AA,PQFP,128P	1	S.A	
....4	R316	2007-000070	R-CHIP;0ohm,5%,1/10W,TP,1608	1	S.A	
....4	R100	2007-000071	R-CHIP;22ohm,5%,1/10W,TP,1608	1	S.A	
....4	R101	2007-000071	R-CHIP;22ohm,5%,1/10W,TP,1608	1	S.A	
....4	R102	2007-000071	R-CHIP;22ohm,5%,1/10W,TP,1608	1	S.A	
....4	R103	2007-000071	R-CHIP;22ohm,5%,1/10W,TP,1608	1	S.A	
....4	R104	2007-000071	R-CHIP;22ohm,5%,1/10W,TP,1608	1	S.A	
....4	R105	2007-000071	R-CHIP;22ohm,5%,1/10W,TP,1608	1	S.A	
....4	R106	2007-000071	R-CHIP;22ohm,5%,1/10W,TP,1608	1	S.A	
....4	R107	2007-000071	R-CHIP;22ohm,5%,1/10W,TP,1608	1	S.A	
....4	R129	2007-000071	R-CHIP;22ohm,5%,1/10W,TP,1608	1	S.A	
....4	R130	2007-000071	R-CHIP;22ohm,5%,1/10W,TP,1608	1	S.A	
....4	R224	2007-000071	R-CHIP;22ohm,5%,1/10W,TP,1608	1	S.A	
....4	R225	2007-000071	R-CHIP;22ohm,5%,1/10W,TP,1608	1	S.A	
....4	R125	2007-000074	R-CHIP;100ohm,5%,1/10W,TP,1608	1	S.A	
....4	R126	2007-000074	R-CHIP;100ohm,5%,1/10W,TP,1608	1	S.A	
....4	R134	2007-000074	R-CHIP;100ohm,5%,1/10W,TP,1608	1	S.A	
....4	R136	2007-000074	R-CHIP;100ohm,5%,1/10W,TP,1608	1	S.A	
....4	R138	2007-000074	R-CHIP;100ohm,5%,1/10W,TP,1608	1	S.A	
....4	R142	2007-000074	R-CHIP;100ohm,5%,1/10W,TP,1608	1	S.A	
....4	R143	2007-000074	R-CHIP;100ohm,5%,1/10W,TP,1608	1	S.A	
....4	R144	2007-000074	R-CHIP;100ohm,5%,1/10W,TP,1608	1	S.A	
....4	R212	2007-000074	R-CHIP;100ohm,5%,1/10W,TP,1608	1	S.A	
....4	R213	2007-000074	R-CHIP;100ohm,5%,1/10W,TP,1608	1	S.A	
....4	R222	2007-000074	R-CHIP;100ohm,5%,1/10W,TP,1608	1	S.A	
....4	R223	2007-000074	R-CHIP;100ohm,5%,1/10W,TP,1608	1	S.A	
....4	R233	2007-000074	R-CHIP;100ohm,5%,1/10W,TP,1608	1	S.A	
....4	R234	2007-000074	R-CHIP;100ohm,5%,1/10W,TP,1608	1	S.A	
....4	R309	2007-000074	R-CHIP;100ohm,5%,1/10W,TP,1608	1	S.A	
....4	R313	2007-000074	R-CHIP;100ohm,5%,1/10W,TP,1608	1	S.A	
....4	R328	2007-000074	R-CHIP;100ohm,5%,1/10W,TP,1608	1	S.A	
....4	R329	2007-000074	R-CHIP;100ohm,5%,1/10W,TP,1608	1	S.A	
....4	R333	2007-000074	R-CHIP;100ohm,5%,1/10W,TP,1608	1	S.A	
....4	R604	2007-000074	R-CHIP;100ohm,5%,1/10W,TP,1608	1	S.A	
....4	R306	2007-000078	R-CHIP;1Kohm,5%,1/10W,TP,1608	1	S.A	
....4	R610	2007-000078	R-CHIP;1Kohm,5%,1/10W,TP,1608	1	S.A	
....4	R109	2007-000080	R-CHIP;2Kohm,5%,1/10W,TP,1608	1	S.A	
....4	R128	2007-000080	R-CHIP;2Kohm,5%,1/10W,TP,1608	1	S.A	
....4	R201	2007-000082	R-CHIP;3.3Kohm,5%,1/10W,TP,1608	1	S.A	
....4	R202	2007-000082	R-CHIP;3.3Kohm,5%,1/10W,TP,1608	1	S.A	
....4	R311	2007-000083	R-CHIP;3Kohm,5%,1/10W,TP,1608	1	S.A	
....4	R330	2007-000083	R-CHIP;3Kohm,5%,1/10W,TP,1608	1	S.A	
....4	R331	2007-000083	R-CHIP;3Kohm,5%,1/10W,TP,1608	1	S.A	
....4	R300	2007-000084	R-CHIP;4.7Kohm,5%,1/10W,TP,1608	1	S.A	
....4	R307	2007-000084	R-CHIP;4.7Kohm,5%,1/10W,TP,1608	1	S.A	
....4	R310	2007-000084	R-CHIP;4.7Kohm,5%,1/10W,TP,1608	1	S.A	
....4	R318	2007-000084	R-CHIP;4.7Kohm,5%,1/10W,TP,1608	1	S.A	
....4	R319	2007-000084	R-CHIP;4.7Kohm,5%,1/10W,TP,1608	1	S.A	
....4	R320	2007-000084	R-CHIP;4.7Kohm,5%,1/10W,TP,1608	1	S.A	
....4	R321	2007-000084	R-CHIP;4.7Kohm,5%,1/10W,TP,1608	1	S.A	
....4	R325	2007-000084	R-CHIP;4.7Kohm,5%,1/10W,TP,1608	1	S.A	
....4	R326	2007-000084	R-CHIP;4.7Kohm,5%,1/10W,TP,1608	1	S.A	

6 Electrical Parts List

Level	Loc. No.	Code No.	Description & Specification	Q'ty	SA/SNA	Remark
....4	R327	2007-000084	R-CHIP;4.7Kohm,5%,1/10W,TP,1608	1	S.A	
....4	R108	2007-000090	R-CHIP;10Kohm,5%,1/10W,TP,1608	1	S.A	
....4	R127	2007-000090	R-CHIP;10Kohm,5%,1/10W,TP,1608	1	S.A	
....4	R220	2007-000090	R-CHIP;10Kohm,5%,1/10W,TP,1608	1	S.A	
....4	R221	2007-000090	R-CHIP;10Kohm,5%,1/10W,TP,1608	1	S.A	
....4	R230	2007-000090	R-CHIP;10Kohm,5%,1/10W,TP,1608	1	S.A	
....4	R231	2007-000090	R-CHIP;10Kohm,5%,1/10W,TP,1608	1	S.A	
....4	R232	2007-000090	R-CHIP;10Kohm,5%,1/10W,TP,1608	1	S.A	
....4	R301	2007-000090	R-CHIP;10Kohm,5%,1/10W,TP,1608	1	S.A	
....4	R304	2007-000090	R-CHIP;10Kohm,5%,1/10W,TP,1608	1	S.A	
....4	R305	2007-000090	R-CHIP;10Kohm,5%,1/10W,TP,1608	1	S.A	
....4	R308	2007-000090	R-CHIP;10Kohm,5%,1/10W,TP,1608	1	S.A	
....4	R315	2007-000090	R-CHIP;10Kohm,5%,1/10W,TP,1608	1	S.A	
....4	R323	2007-000090	R-CHIP;10Kohm,5%,1/10W,TP,1608	1	S.A	
....4	R324	2007-000090	R-CHIP;10Kohm,5%,1/10W,TP,1608	1	S.A	
....4	R210	2007-000092	R-CHIP;15Kohm,5%,1/10W,TP,1608	1	S.A	
....4	R211	2007-000092	R-CHIP;15Kohm,5%,1/10W,TP,1608	1	S.A	
....4	R214	2007-000092	R-CHIP;15Kohm,5%,1/10W,TP,1608	1	S.A	
....4	R302	2007-000102	R-CHIP;100Kohm,5%,1/10W,TP,1608	1	S.A	
....4	R303	2007-000124	R-CHIP;2.2Kohm,5%,1/10W,TP,1608	1	S.A	
....4	R314	2007-000608	R-CHIP;240ohm,5%,1/10W,TP,1608	1	S.A	
....4	R110	2007-001002	R-CHIP;510ohm,5%,1/10W,TP,1608	1	S.A	
....4	R145	2007-001164	R-CHIP;75ohm,1%,1/10W,TP,1608	1	S.A	
....4	R146	2007-001164	R-CHIP;75ohm,1%,1/10W,TP,1608	1	S.A	
....4	R147	2007-001164	R-CHIP;75ohm,1%,1/10W,TP,1608	1	S.A	
....4	C302	2203-000041	C-CER,CHIP;0.01nF,0.25pF,50V,C0G,1608	1	S.A	
....4	C303	2203-000041	C-CER,CHIP;0.01nF,0.25pF,50V,C0G,1608	1	S.A	
....4	C203	2203-000189	C-CER,CHIP;100nF,+80-20%,25V,Y5V,1608	1	S.A	
....4	C126	2203-000257	C-CER,CHIP;10nF,10%,50V,X7R,1608	1	S.A	
....4	C127	2203-000257	C-CER,CHIP;10nF,10%,50V,X7R,1608	1	S.A	
....4	C128	2203-000257	C-CER,CHIP;10nF,10%,50V,X7R,1608	1	S.A	
....4	C129	2203-000257	C-CER,CHIP;10nF,10%,50V,X7R,1608	1	S.A	
....4	C130	2203-000257	C-CER,CHIP;10nF,10%,50V,X7R,1608	1	S.A	
....4	C131	2203-000257	C-CER,CHIP;10nF,10%,50V,X7R,1608	1	S.A	
....4	C201	2203-000257	C-CER,CHIP;10nF,10%,50V,X7R,1608	1	S.A	
....4	C202	2203-000257	C-CER,CHIP;10nF,10%,50V,X7R,1608	1	S.A	
....4	C300	2203-000257	C-CER,CHIP;10nF,10%,50V,X7R,1608	1	S.A	
....4	C103	2203-000440	C-CER,CHIP;1nF,10%,50V,X7R,1608	1	S.A	
....4	C140	2203-000872	C-CER,CHIP;0.0030nF,0.25pF,50V,C0G,1608	1	S.A	
....4	C141	2203-000872	C-CER,CHIP;0.0030nF,0.25pF,50V,C0G,1608	1	S.A	
....4	C142	2203-000872	C-CER,CHIP;0.0030nF,0.25pF,50V,C0G,1608	1	S.A	
....4	C607	2203-001652	C-CER,CHIP;470nF,+80-20%,16V,Y5V,1608	1	S.A	
....4	C105	2203-005005	C-CER,CHIP;100nF,10%,16V,X7R,1608	1	S.A	
....4	C106	2203-005005	C-CER,CHIP;100nF,10%,16V,X7R,1608	1	S.A	
....4	C110	2203-005005	C-CER,CHIP;100nF,10%,16V,X7R,1608	1	S.A	
....4	C111	2203-005005	C-CER,CHIP;100nF,10%,16V,X7R,1608	1	S.A	
....4	C112	2203-005005	C-CER,CHIP;100nF,10%,16V,X7R,1608	1	S.A	
....4	C113	2203-005005	C-CER,CHIP;100nF,10%,16V,X7R,1608	1	S.A	
....4	C114	2203-005005	C-CER,CHIP;100nF,10%,16V,X7R,1608	1	S.A	
....4	C115	2203-005005	C-CER,CHIP;100nF,10%,16V,X7R,1608	1	S.A	
....4	C116	2203-005005	C-CER,CHIP;100nF,10%,16V,X7R,1608	1	S.A	
....4	C117	2203-005005	C-CER,CHIP;100nF,10%,16V,X7R,1608	1	S.A	
....4	C118	2203-005005	C-CER,CHIP;100nF,10%,16V,X7R,1608	1	S.A	
....4	C119	2203-005005	C-CER,CHIP;100nF,10%,16V,X7R,1608	1	S.A	
....4	C123	2203-005005	C-CER,CHIP;100nF,10%,16V,X7R,1608	1	S.A	
....4	C210	2203-005005	C-CER,CHIP;100nF,10%,16V,X7R,1608	1	S.A	
....4	C220	2203-005005	C-CER,CHIP;100nF,10%,16V,X7R,1608	1	S.A	
....4	C230	2203-005005	C-CER,CHIP;100nF,10%,16V,X7R,1608	1	S.A	
....4	C307	2203-005005	C-CER,CHIP;100nF,10%,16V,X7R,1608	1	S.A	
....4	C308	2203-005005	C-CER,CHIP;100nF,10%,16V,X7R,1608	1	S.A	
....4	C310	2203-005005	C-CER,CHIP;100nF,10%,16V,X7R,1608	1	S.A	

Level	Loc. No.	Code No.	Description & Specification	Q'ty	SA/SNA	Remark
....4	C610	2203-005005	C-CER,CHIP;100nF,10%,16V,X7R,1608	1	S.A	
....4	C611	2203-005005	C-CER,CHIP;100nF,10%,16V,X7R,1608	1	S.A	
....4	C615	2203-005005	C-CER,CHIP;100nF,10%,16V,X7R,1608	1	S.A	
....4	C616	2203-005005	C-CER,CHIP;100nF,10%,16V,X7R,1608	1	S.A	
....4	C617	2203-005005	C-CER,CHIP;100nF,10%,16V,X7R,1608	1	S.A	
....4	C618	2203-005005	C-CER,CHIP;100nF,10%,16V,X7R,1608	1	S.A	
....4	C619	2203-005005	C-CER,CHIP;100nF,10%,16V,X7R,1608	1	S.A	
....4	C620	2203-005005	C-CER,CHIP;100nF,10%,16V,X7R,1608	1	S.A	
....4	C622	2203-005005	C-CER,CHIP;100nF,10%,16V,X7R,1608	1	S.A	
....4	C623	2203-005005	C-CER,CHIP;100nF,10%,16V,X7R,1608	1	S.A	
....4	C624	2203-005005	C-CER,CHIP;100nF,10%,16V,X7R,1608	1	S.A	
....4	C625	2203-005005	C-CER,CHIP;100nF,10%,16V,X7R,1608	1	S.A	
....4	C635	2203-005005	C-CER,CHIP;100nF,10%,16V,X7R,1608	1	S.A	
....4	C636	2203-005005	C-CER,CHIP;100nF,10%,16V,X7R,1608	1	S.A	
....4	C638	2203-005005	C-CER,CHIP;100nF,10%,16V,X7R,1608	1	S.A	
....4	C639	2203-005005	C-CER,CHIP;100nF,10%,16V,X7R,1608	1	S.A	
....4	C641	2203-005005	C-CER,CHIP;100nF,10%,16V,X7R,1608	1	S.A	
....4	C642	2203-005005	C-CER,CHIP;100nF,10%,16V,X7R,1608	1	S.A	
....4	C643	2203-005005	C-CER,CHIP;100nF,10%,16V,X7R,1608	1	S.A	
....4	C648	2203-005005	C-CER,CHIP;100nF,10%,16V,X7R,1608	1	S.A	
....4	C649	2203-005005	C-CER,CHIP;100nF,10%,16V,X7R,1608	1	S.A	
....4	C650	2203-005005	C-CER,CHIP;100nF,10%,16V,X7R,1608	1	S.A	
....4	C651	2203-005005	C-CER,CHIP;100nF,10%,16V,X7R,1608	1	S.A	
....4	C652	2203-005005	C-CER,CHIP;100nF,10%,16V,X7R,1608	1	S.A	
....4	C653	2203-005005	C-CER,CHIP;100nF,10%,16V,X7R,1608	1	S.A	
....4	C304	2203-005065	C-CER,CHIP;1000nF,+80-20%,10V,Y5V,1608	1	S.A	
....4	C305	2203-005065	C-CER,CHIP;1000nF,+80-20%,10V,Y5V,1608	1	S.A	
....4	C309	2203-005065	C-CER,CHIP;1000nF,+80-20%,10V,Y5V,1608	1	S.A	
....4	C311	2203-005065	C-CER,CHIP;1000nF,+80-20%,10V,Y5V,1608	1	S.A	
....4	C312	2203-005065	C-CER,CHIP;1000nF,+80-20%,10V,Y5V,1608	1	S.A	
....4	C614	2203-005437	C-CER,CHIP;10000nF,+80-20%,10V,Y5V,3216	1	S.A	
....4	C621	2203-005437	C-CER,CHIP;10000nF,+80-20%,10V,Y5V,3216	1	S.A	
....4	C634	2203-005437	C-CER,CHIP;10000nF,+80-20%,10V,Y5V,3216	1	S.A	
....4	C637	2203-005437	C-CER,CHIP;10000nF,+80-20%,10V,Y5V,3216	1	S.A	
....4	C306	2402-001128	C-AL,SMD;100#iF,20%,16V,-,TP,6.3X5.7mm	1	S.A	
....4	C608	2402-001128	C-AL,SMD;100#iF,20%,16V,-,TP,6.3X5.7mm	1	S.A	
....4	C609	2402-001128	C-AL,SMD;100#iF,20%,16V,-,TP,6.3X5.7mm	1	S.A	
....4	C644	2402-001128	C-AL,SMD;100#iF,20%,16V,-,TP,6.3X5.7mm	1	S.A	
....4	X300	2801-003667	CRYSTAL-SMD;14.31818MHz,30ppm,28-AAN,16,	1	S.A	
....4	T0568	3301-001145	BEAD-SMD;60ohm,4516,TP,70ohm/45MHz,82ohm	1	S.N.A	
....4	T0568	3301-001145	BEAD-SMD;60ohm,4516,TP,70ohm/45MHz,82ohm	1	S.N.A	
....4	T0568	3301-001145	BEAD-SMD;60ohm,4516,TP,70ohm/45MHz,82ohm	1	S.N.A	
....4	T0568	3301-001145	BEAD-SMD;60ohm,4516,TP,70ohm/45MHz,82ohm	1	S.N.A	
....4	T0568	3301-001145	BEAD-SMD;60ohm,4516,TP,70ohm/45MHz,82ohm	1	S.N.A	
....4	T0568	3301-001145	BEAD-SMD;60ohm,4516,TP,70ohm/45MHz,82ohm	1	S.N.A	
....4	T0568	3301-001145	BEAD-SMD;60ohm,4516,TP,70ohm/45MHz,82ohm	1	S.N.A	
....4	T0568	3301-001145	BEAD-SMD;60ohm,4516,TP,70ohm/45MHz,82ohm	1	S.N.A	
....4	T0568	3301-001145	BEAD-SMD;60ohm,4516,TP,70ohm/45MHz,82ohm	1	S.N.A	
....4	T0568	3301-001145	BEAD-SMD;60ohm,4516,TP,70ohm/45MHz,82ohm	1	S.N.A	
....4	CN400	3708-001150	CONNECTOR-FPC/FFC/PIC;30P,1mm,SMD-A,SN,Y	1	S.A	
....4	CN330	3711-005503	HEADER-BOARD TO CABLE;BOX,9P,1R,2mm,SMD-	1	S.A	
....4	CN330	3711-005509	HEADER-BOARD TO CABLE;BOX,4P,1R,1.25mm,S	1	S.A	
....4	MAIN_MICOM	BN97-01171A	ASSY MICOM-STZ,W/W;M-PE19B9Aa-1000(790,	1	S.A	
....5	IC115	1107-001561	IC-FLASH MEMORY;25VF010,128Kx8Bit,SOP,8P	1	S.N.A	
....4	T0077	BN41-00792A	PCB MAIN;LS19PEB,Silver through,2,MP1.0,	1	S.N.A	
..2	M2893	BN96-02854H	ASSY MISC P-FFC CABLE;MENDEL,FFC CABLE,1	1	S.N.A	
..2	M0006	BN96-04145A	ASSY SHIELD P-COVER;PEBBLE19,SECC,TO.8	1	S.N.A	
...3		BN61-02429D	STUD-PEM;PNB,M2.8,D7,L20,ZPC(SIL),SUM24L	1	S.N.A	
...3	M0107	BN63-02886A	SHIELD-COVER;PEBBLE,SECC,0.8,19INCH	1	S.N.A	
...3	M0114	BP61-01088A	HOLDER-WIRE;SVP-42L6,NYLON	1	S.N.A	
...3	M0131	AA63-01240A	GASKET;FIRENZE,Conductive Fabric,3mm,12m	2	S.N.A	
..2	M0524	BP39-00028A	CONNECT WIRE;BI17,19BS,UL1007#26,9P,80mm	1	S.A	

6 Electrical Parts List

Level	Loc. No.	Code No.	Description & Specification	Q'ty	SA/SNA	Remark
..2	T0562	6046-001013	STAND OFF;M3,L5,Ni PLT,SUM24L,#4-40	4	S.N.A	
..2	M0174	BN44-00124E	IP BOARD;IP-35155A(P),Pebble,3.0 -5.0mA,	1	S.A	
0.1	M0112	BN91-01212A	ASSY SHIELD;LS19PEBSW/EDC	1	S.N.A	
..2		BN63-02887A	SHIELD-LAMP;PEBBLE,SPT,0.3,19INCH	1	S.N.A	
0.1	M0019	BN92-02024A	ASSY LABEL;LS17PEASW/EDC,SAA4	1	S.N.A	
0.1	M0045	BN92-02025B	ASSY ACCESSORY;LS19PEBSW/EDC,SAA4	1	S.N.A	
..2	M0114	BN39-00244B	CBF SIGNAL;MO15PS,15P/15P,20276-N,1830mm	1	S.A	
..2	M0125	BN39-00246F	CBF SIGNAL-DVI(D);1703FP,24P/24P,20276-D	1	S.A	
..2	M0013	BN96-04154A	ASSY STAND P-BASE;PEBBLE19,ABS HB,WH13,S	1	S.A	
..3	M0081	6003-000282	SCREW-TAPTITE;BH,+,-,B,M3,L8,ZPC(BLK),SW	4	S.N.A	
...3	CIS4	BN61-01717A	HOLDER-STAND;BIZET,NI PLT,CH,+,M4,L11(5)	1	S.N.A	
...3		BN61-02785A	BRACKET-STAND BODY;PEBBLE,SECC,0.8	1	S.N.A	
...3	T0004	BN63-02882A	COVER-STAND BASE;PEBBLE,ABS HB,2.6,WH13,	1	S.N.A	
...3	T0132	BN73-00077A	RUBBER FOOT;MATISSE,BUMPON,*13.5,T2.0,6	4	S.N.A	
...3	T0524	6902-000389	BAG PE;HDPE/NITRON/HDPE,T0.015/T0.5/T0.0	1	S.N.A	
...3	CCM1	BN63-02183C	COVER-SHEET;RhcM,PE Vinyl,T0.05,200mm,20	0.3	S.N.A	
...3		BN68-01115A	MANUAL FLYER-QSG;COMM,SyncMaster,korean,	1	S.N.A	
..2	M0045	BN96-04279A	ASSY ACCESSORY;LS17PEASW/EDC,SAA4	1	S.A	
...3	T0268	3903-000042	CBF-POWER CORD;DT,EU,FP3/YES,IEC320 C13/	1	S.A	
...3	T0524	6902-000110	BAG PE;LDPE,T0.05,W250,L400,TRP,28,2	1	S.N.A	
...3	T0238	BH68-00633A	MANUAL FLYER-WARRANTY CARD;comm,Samsung,	1	S.N.A	
...3	ACCESSORY	BH68-70448A	CARD-01;TFT LCD,SRC,RUSSIA,S/W,120,W210*	1	S.N.A	
...3	T0059	BN68-00907A	MANUAL FLYER-CARD;COMM,SAMSUNG,18 LANG,E	1	S.N.A	
...3	M0215	BN96-04304A	ASSY MANUAL P-IB+QSG;932B,732N,SyncMaste	1	S.N.A	
....4	QSG	BH68-00376L	MANUAL FLYER-04,QSG;LCDQUICK SETUP GUIDE	1	S.N.A	
....4	IB	BN59-00585A	S/W DRIVER-00,IB;932B,732N,W/W,SyncMaste	1	S.N.A	
..2		BN68-01115C	MANUAL FLYER-QSG;COMM,SyncMaster,korean,	1	S.N.A	
..2	M0013	BN96-04150C	ASSY STAND P-BAR;PEBBLE17,ABS HB,WH13,SF	1	S.A	
..3	M0081	6003-000282	SCREW-TAPTITE;BH,+,-,B,M3,L8,ZPC(BLK),SW	2	S.N.A	
..3	T0524	6902-000023	BAG PE;LDPE,T0.08,L120,W150,TRP,,,PE MAR	1	S.N.A	
..3		BN61-02783C	STAND-BAR;PEBBLE,ABS HB,SI-212DG-U,WH13,	1	S.N.A	
..3		BN61-02786A	BRACKET-PLATE;PEBBLE,SECC,1.0	1	S.N.A	
0.1	M0113	BN92-02029B	ASSY P/MATERIAL;LS19PEB*,SAA4,PEBBLE	1	S.N.A	
..2	T0524	6902-000241	BAG PE;NITRON/HDPE,T0.5/T0.012,W600,L600	1	S.N.A	
..2	T0376	6902-000379	BAG AIR;LDPE,T0.2,W1000,L1800,TRP,-,-	0.001	S.N.A	
..2	T0003	6902-000604	BAG WRAPPING;LDPE,T0.02,W500,L10000,TRP,	0.85	S.N.A	
..2	M0081	6902-000609	BAG ROLL;LDPE,T0.05,W2400,L1000,TRP,-,-	0.018	S.N.A	
0.1	M0003	BN92-02030B	ASSY BOX;LS19PEBSW/EDC,SAA4	1	S.N.A	
..2	M0045	BN69-01527A	BOX-MONITOR;LS19PB,SY-01,A,A1,W476,D426,	1.02	S.N.A	
..2	T0081	BN96-02895A	ASSY MISC P-HANDLE PACKING;ALL MODEL,BN6	1	S.N.A	
..3	M0103	BN66-00007A	LEVER-TOP;ALL MODEL,LDPE,WHITE	1	S.N.A	
..3	M0102	BN66-00008A	LEVER-BOTTOM;ALL MODEL,LDPE,WHITE	1	S.N.A	

7 Block Diagram

7-1 Power Tree

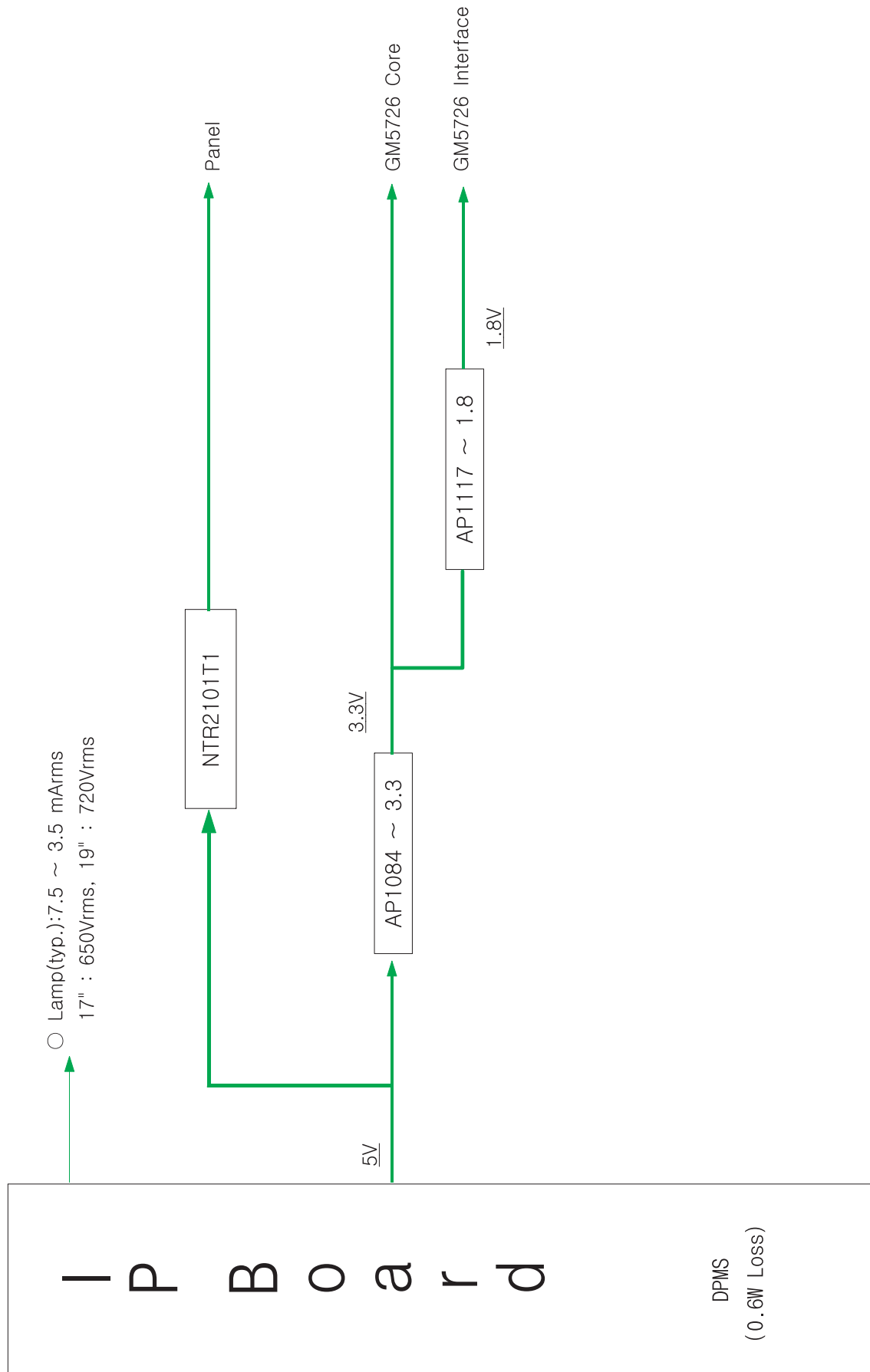

7-2 Main Board Part (17")

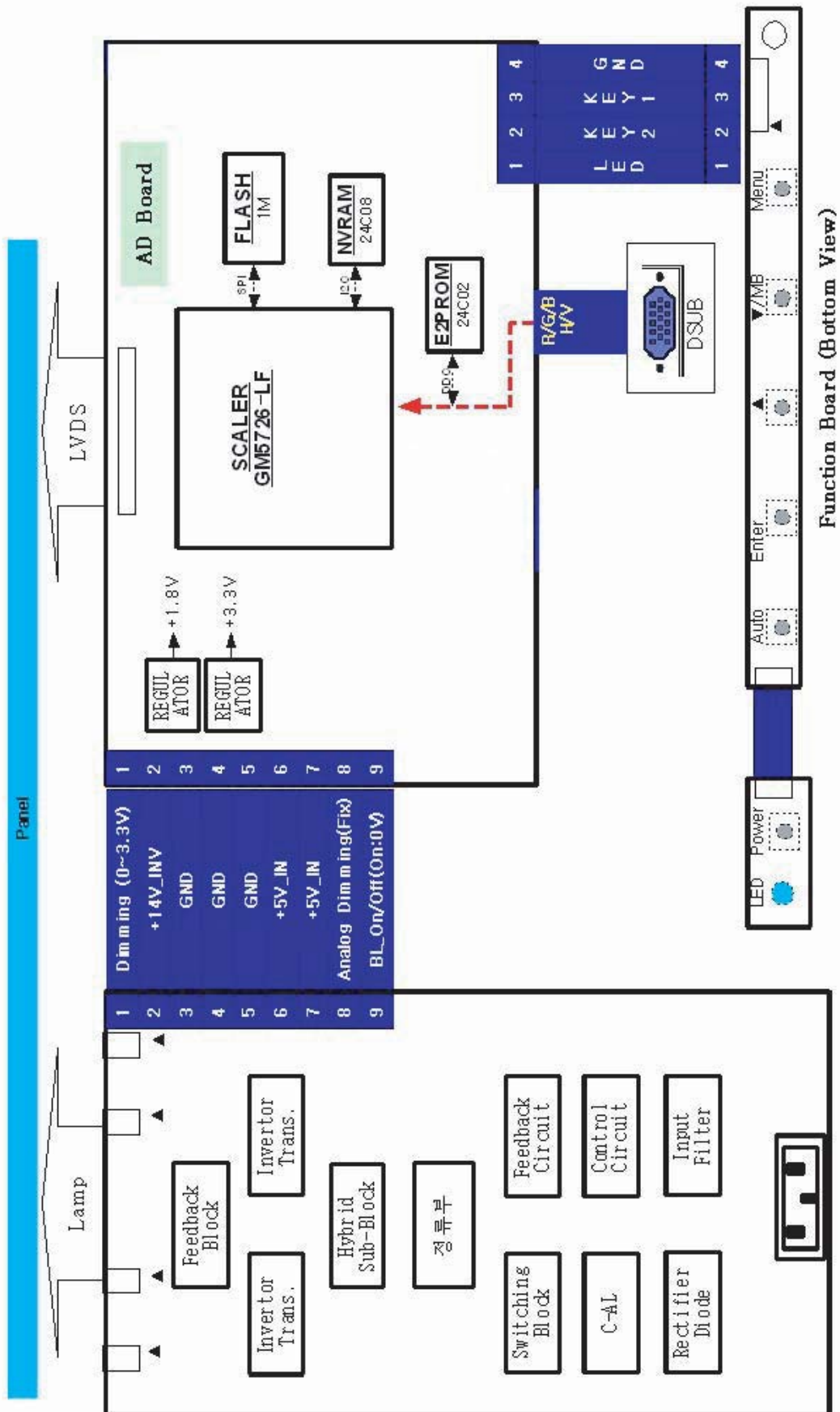

7-3 Main Board Part (19")

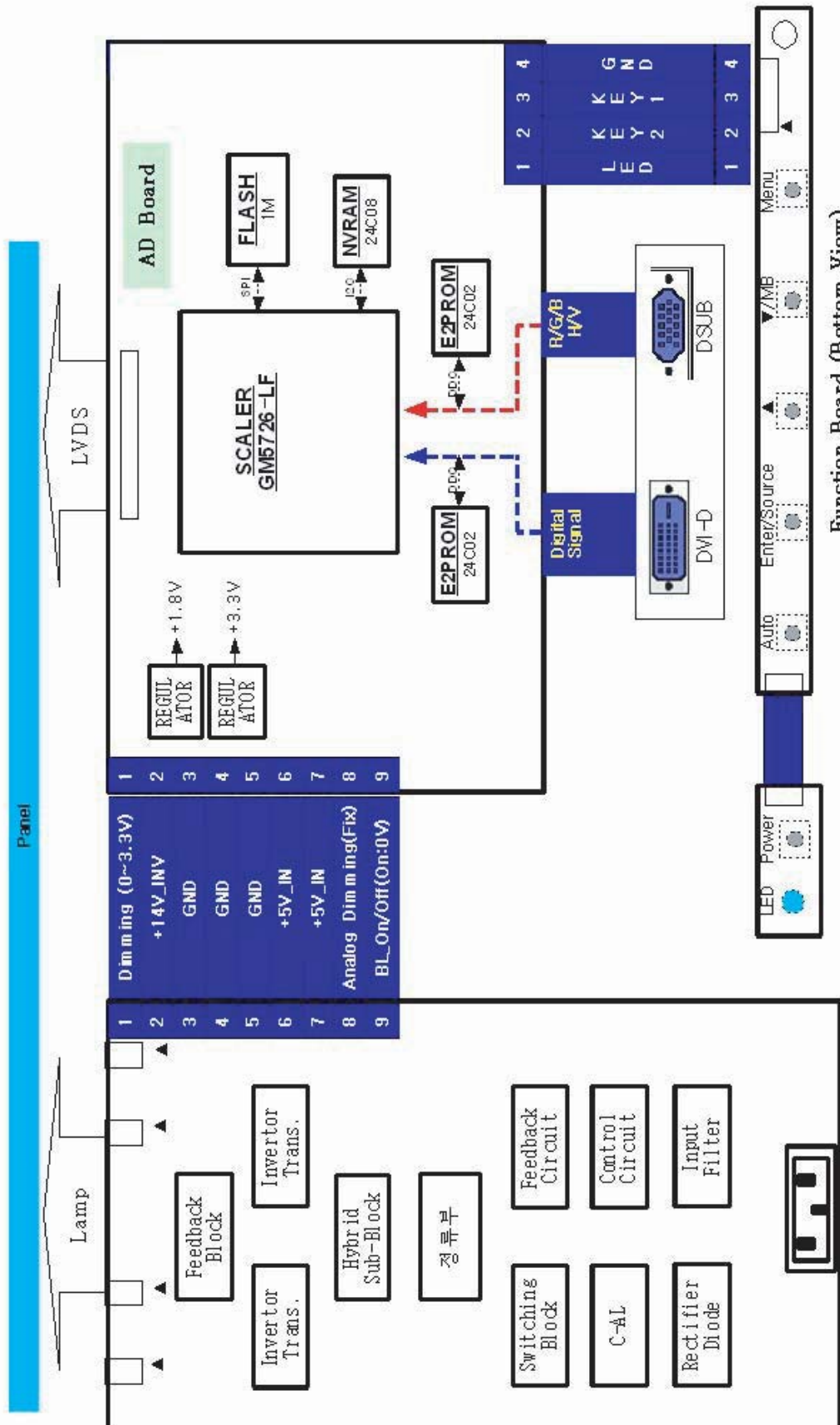

7-4 IP Board Part (SMPS Part)

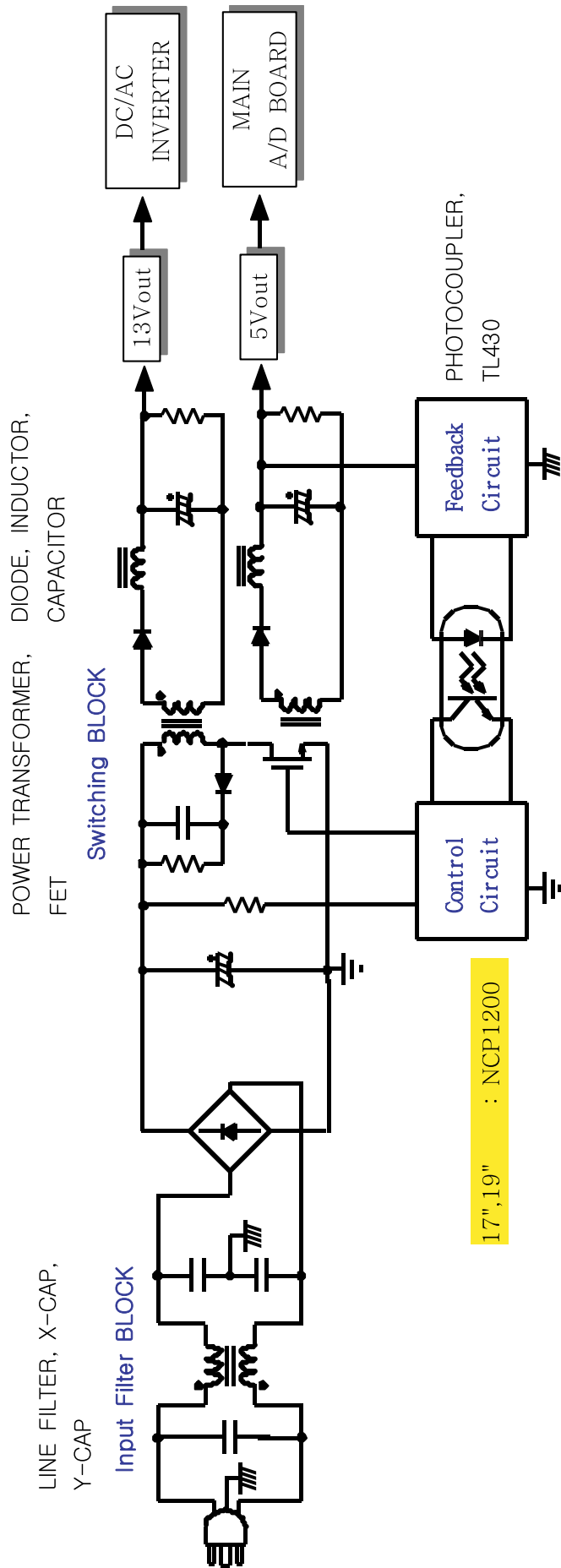

7-5 IP Board Part (Inverter Part)

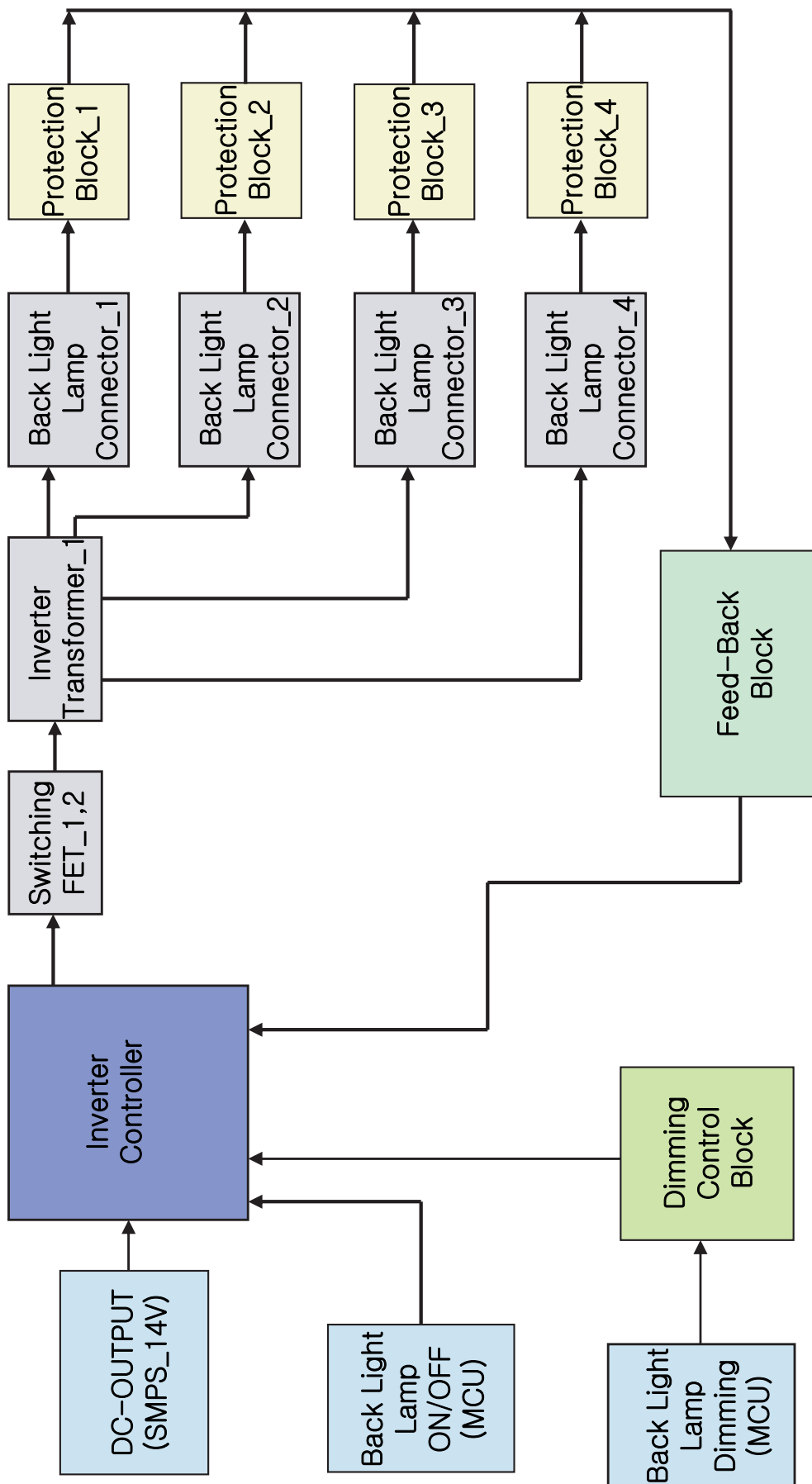

Memo

8 Wiring Diagram

8-1 Wiring Diagram 17"

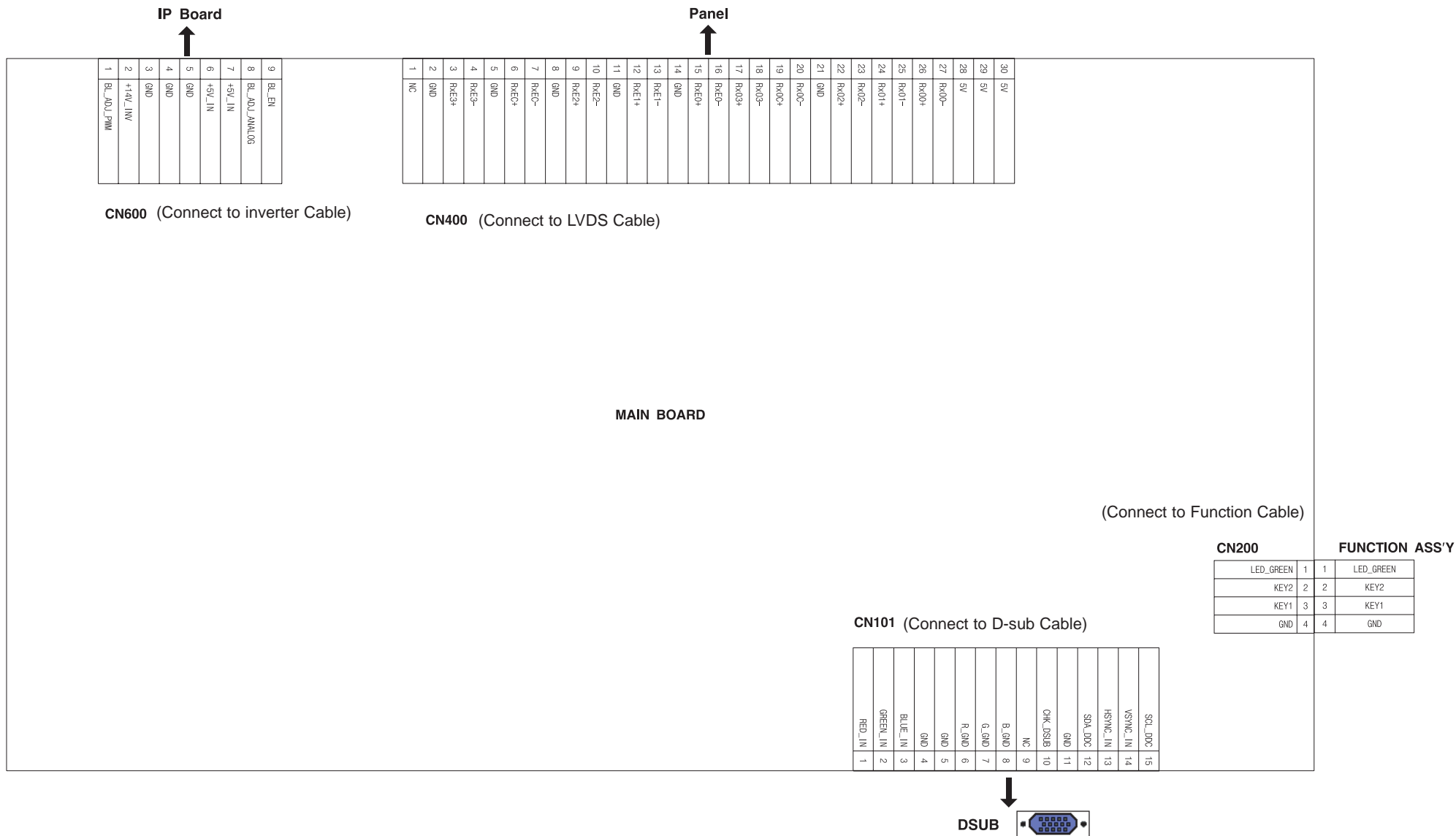

8-2 Wiring Diagram (19")

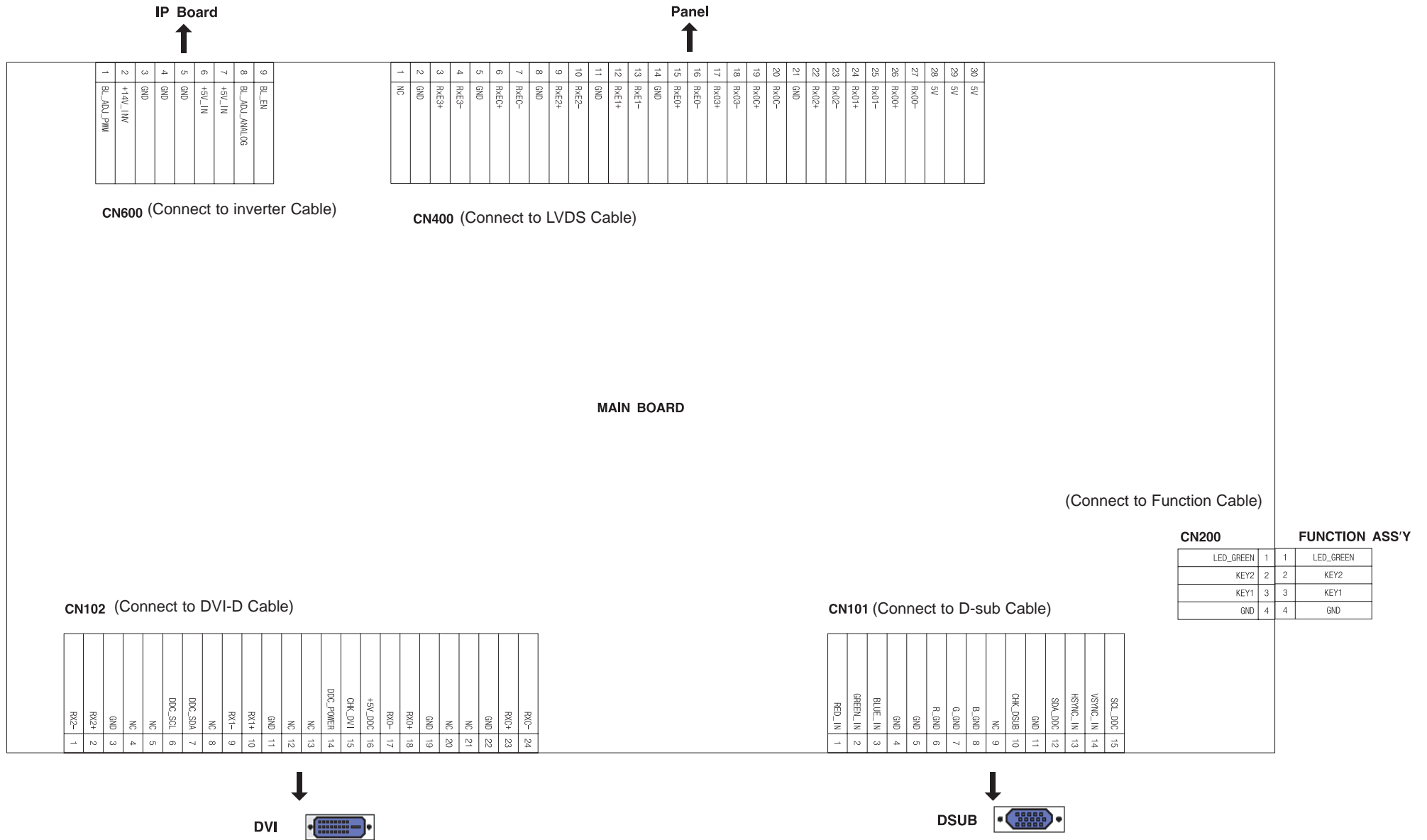

8-3 Wiring Diagram (Code No.)

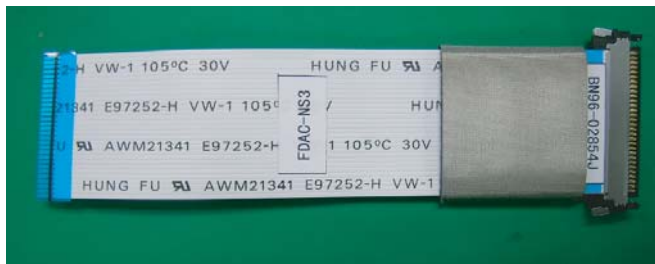

17" LVDS cable: BN96-02854J



19" LVDS cable: BN96-02854H



IP board - Main PBA Cable: BP39-00028A

9 Schematic Diagrams

9-1 Schematic Diagrams (17")

- This Document can not be used without Samsung's authorization.

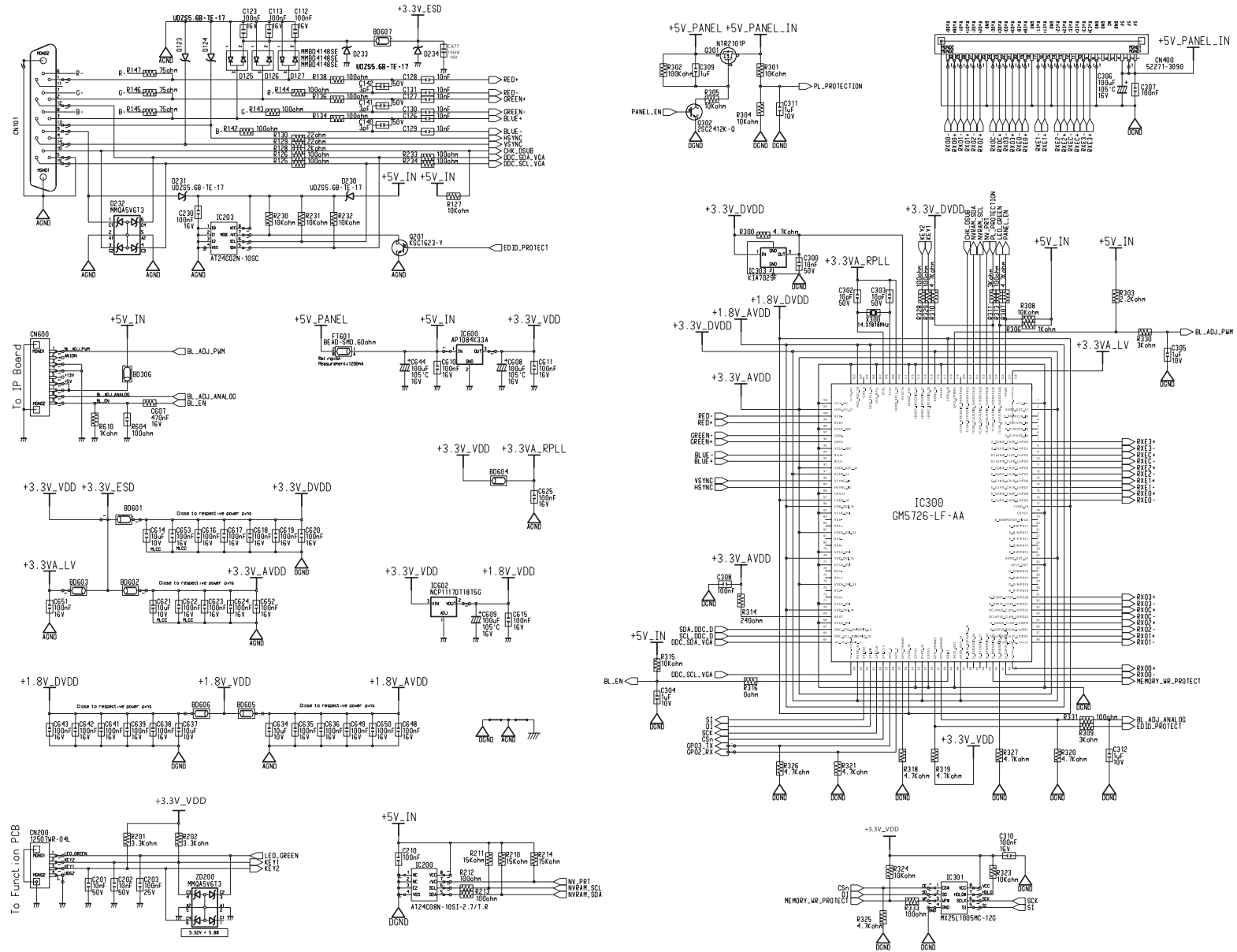

9-2 Schematic Diagrams (19")

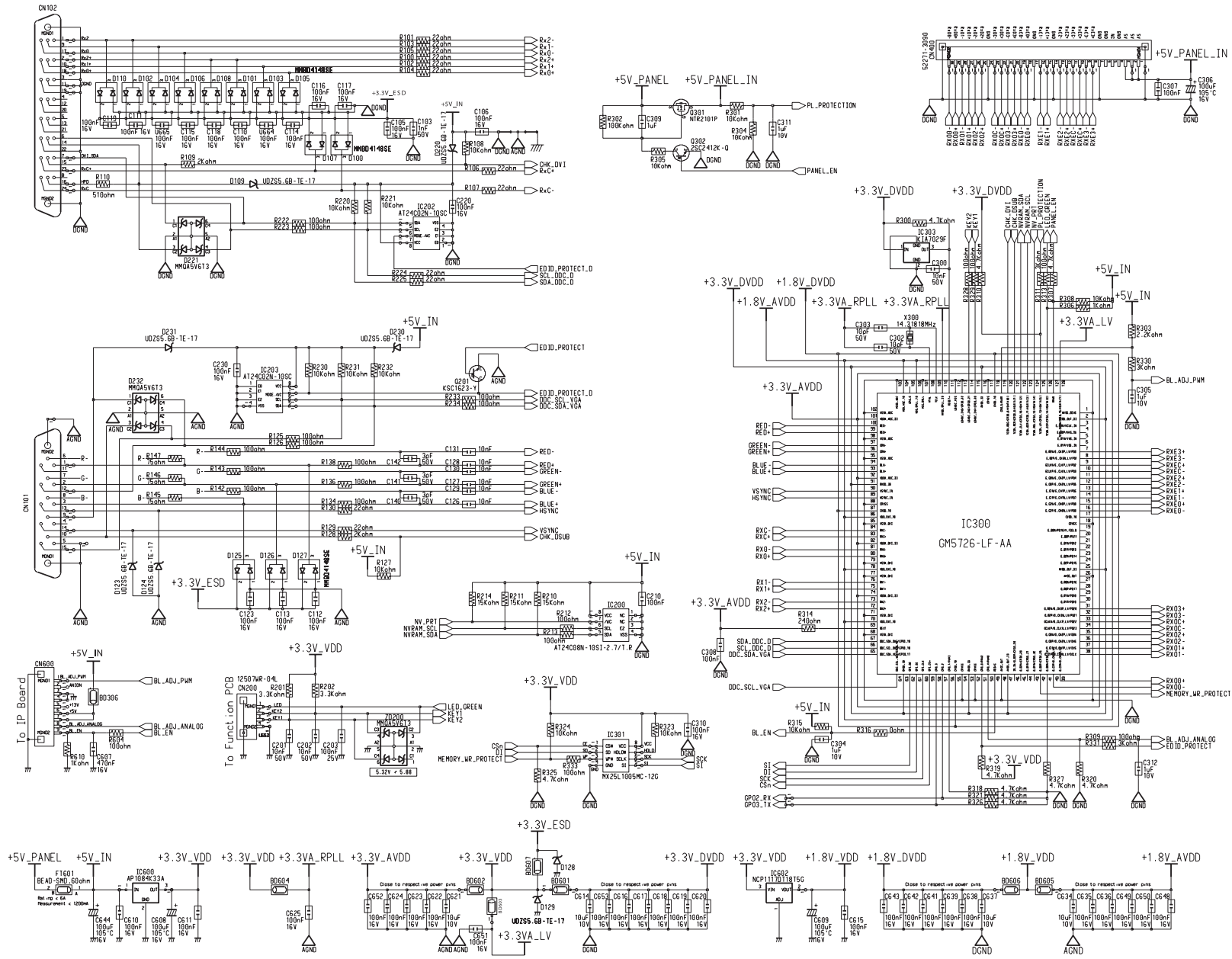

10 Operating Instructions and Installation

10-1 Front

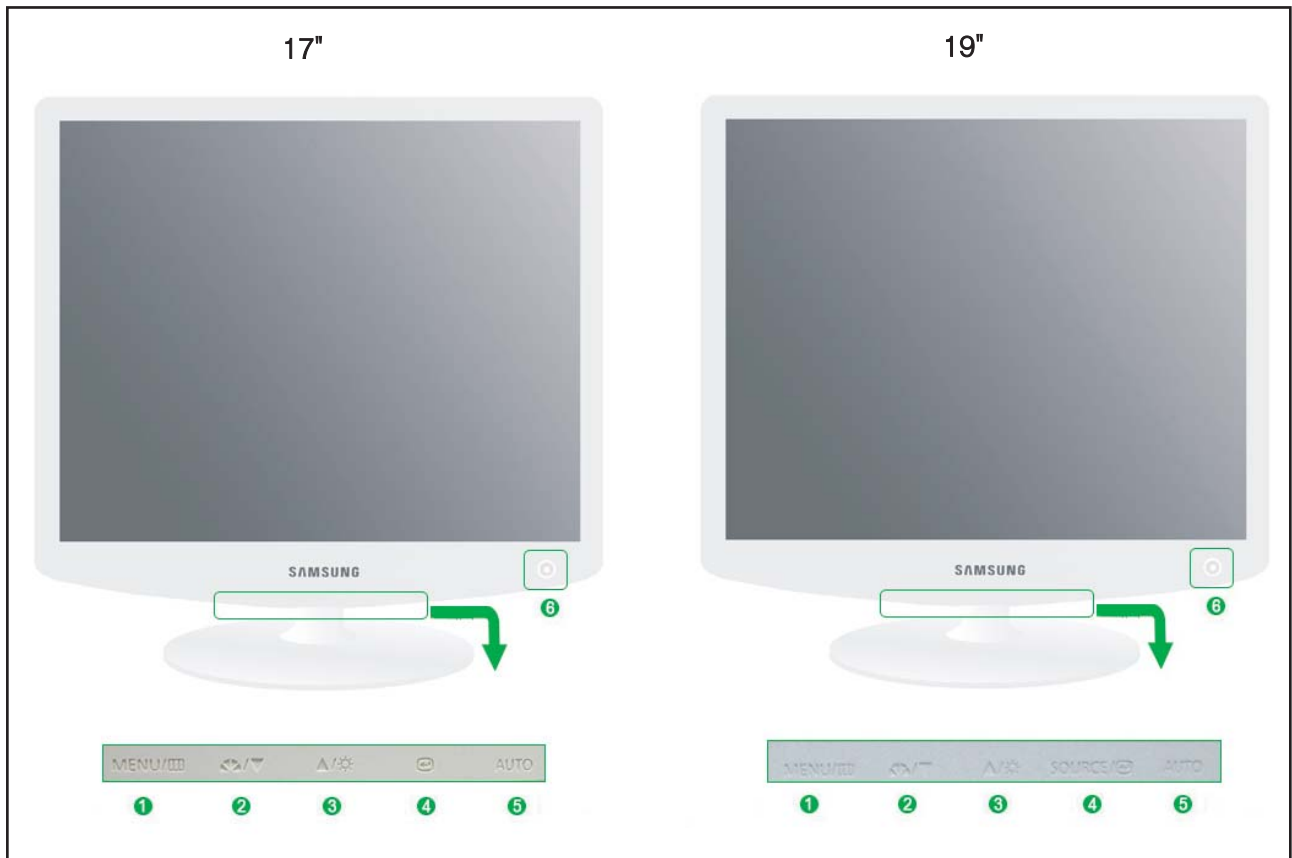

1. Menu button

Opens the OSD menu. Also use to exit the OSD menu or return to the previous menu.

2. MagicBright button

MagicBright is a new feature providing optimum viewing environment depending on the contents of the image you are watching. Currently six different modes are available: Custom, Text, Internet, Game, Sport and Movie. Each mode has its own pre-configured brightness value. You can easily select one of six settings by simply pressing MagicBright control buttons.

1) Custom

Although the values are carefully chosen by our engineers, the pre-configured values may not be comfortable to your eyes depending on your taste. If this is the case, adjust the brightness and contrast by using the OSD menu.

2) Text

For documentations or works involving heavy text.

3) Internet

For working with a mixture of images such as text and graphics.

4) Game

For watching motion pictures such as a game.

5) Sport

For watching motion pictures such as a sport.

6) Movie

For watching motion pictures such as a DVD or Video CD.

7) Dynamic Contrast

Dynamic Contrast is to automatically detect distribution of inputted visual signal and adjust to create optimum contrast.

3. Brightness button

When OSD is not on the screen, push the button to adjust brightness.

2,3. Adjust buttons

Adjust items in the menu.

4. Enter button (17")

Activates a highlighted menu item.

4. Enter button / SOURCE button (19")

Activates a highlighted menu item. /

Push the 'SOURCE', then selects the video signal while the OSD is off. (When the source button is pressed to change the input mode, a message appears in the upper left of the screen displaying the current mode -- analog or digital input signal.)

5. AUTO button

Use this button for auto adjustment.

6. Power button

Use this button for turn the monitor on and off.

Power indicator

This light glows green during normal operation, and blinks green once as the monitor saves your adjustments.

10-2 Rear

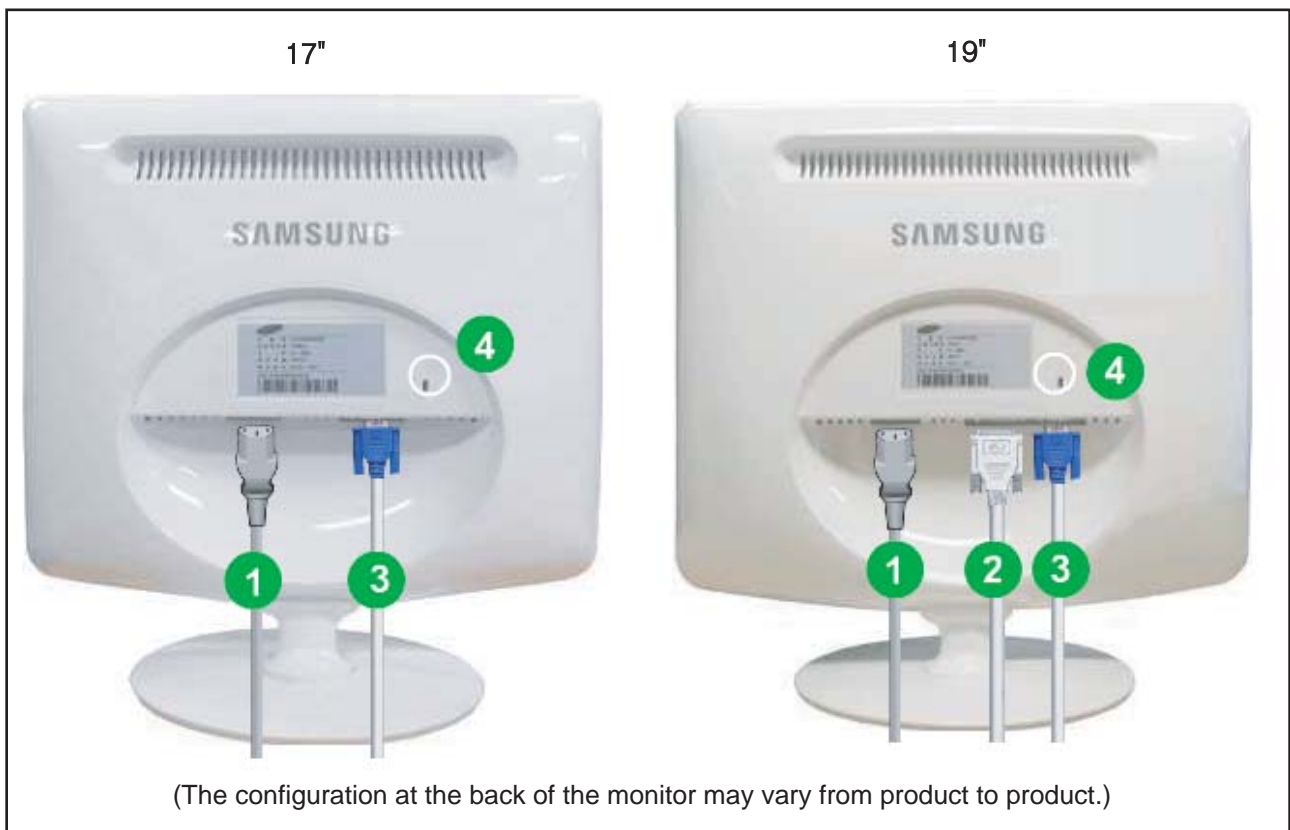

1. Power port

Connect the power cord for your monitor to the power port on the back of the monitor.

2. DVI IN port

Connect the DVI cable to the DVI port on the back of your monitor.

3. RGB IN port

Connect the signal cable to the 15-pin, D-sub port on the back of your monitor.

4. Kensington Lock

The Kensington lock is a device used to physically fix the system when using it in a public place.

10-3 Connecting the monitor (17")

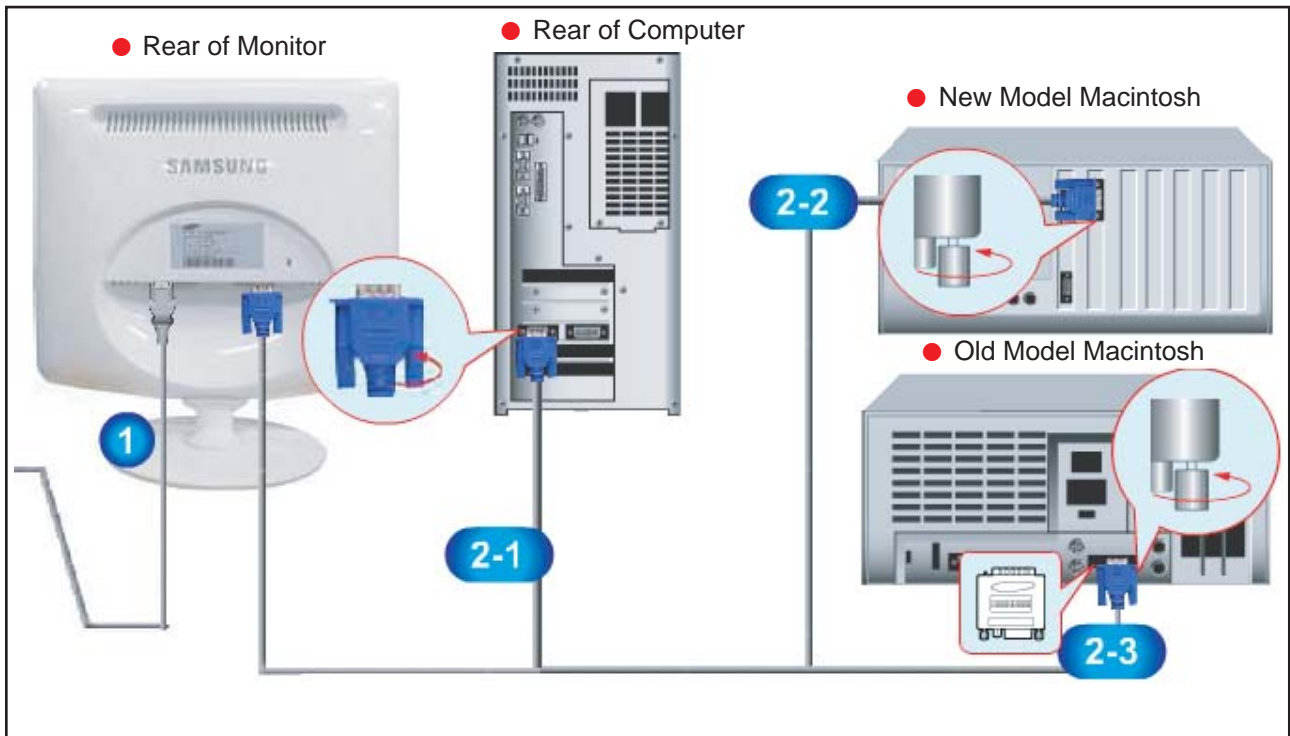

1. Connect the power cord for your monitor to the power port on the back of the monitor. Plug the power cord for the monitor into a nearby outlet.

2-1. Using the D-sub (Analog) connector on the video card. Connect the signal cable to the 15-pin, D-sub connector on the back of your monitor.



2-2. Connected to a Macintosh. Connect the monitor to the Macintosh computer using the D-SUB connection cable.

2-3. In the case of an old model Macintosh, you need to connect the monitor using a special Mac adapter.

3. Turn on your computer and monitor. If your monitor displays an image, installation is complete.

10-3-1 Connecting the monitor (19")

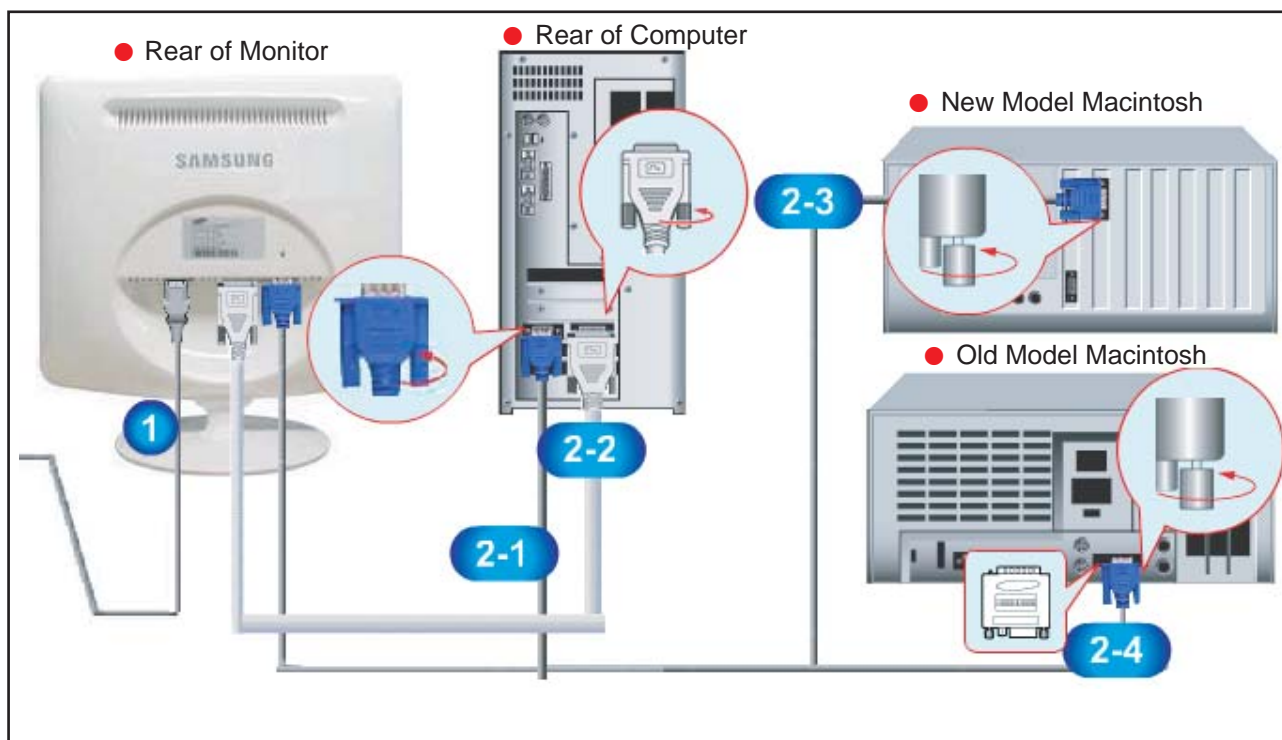

1. Connect the power cord for your monitor to the power port on the back of the monitor. Plug the power cord for the monitor into a nearby outlet.

2-1. Using the D-sub (Analog) connector on the video card. Connect the signal cable to the 15-pin, D-sub connector on the back of your monitor.



2-2. Using the DVI (Digital) connector on the video card. Connect the DVI cable to the DVI port on the back of your monitor.



2-3. Connected to a Macintosh. Connect the monitor to the Macintosh computer using the D-SUB connection cable.

2-4. In the case of an old model Macintosh, you need to connect the monitor using a special Mac adapter.

3. Turn on your computer and monitor. If your monitor displays an image, installation is complete.



11 Disassembly and Reassembly



This section of the service manual describes the disassembly and reassembly procedures for the LS17PEA/LS19PEB TFT-LCD monitors.

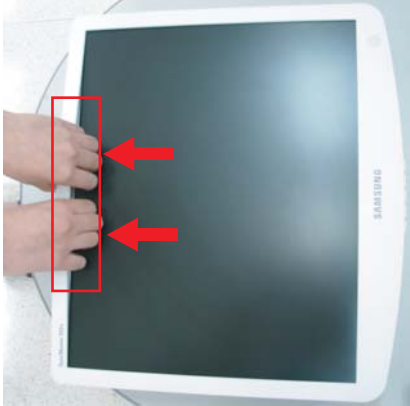

⚠ WARNING: This monitor contains electrostatically sensitive devices. Use caution when handling these components.

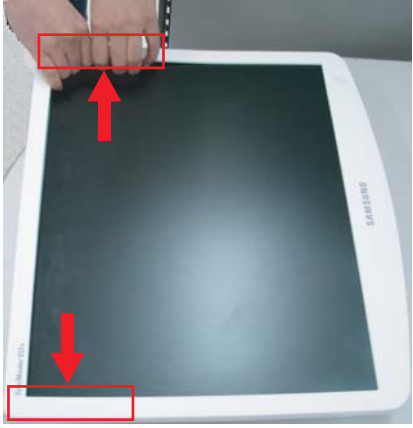
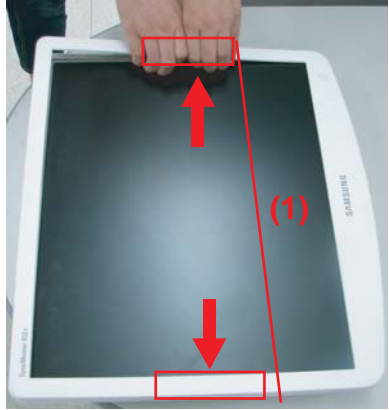

11-1 Disassembly

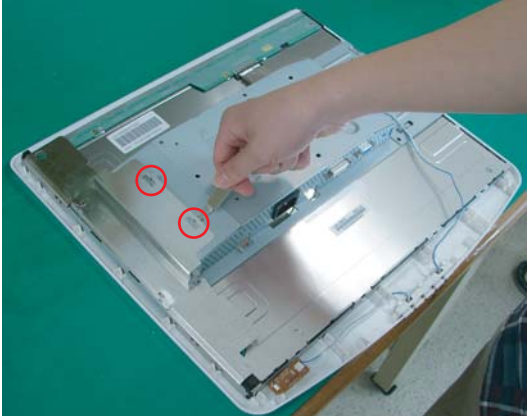

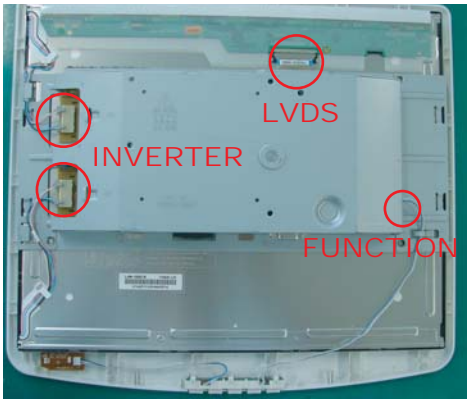
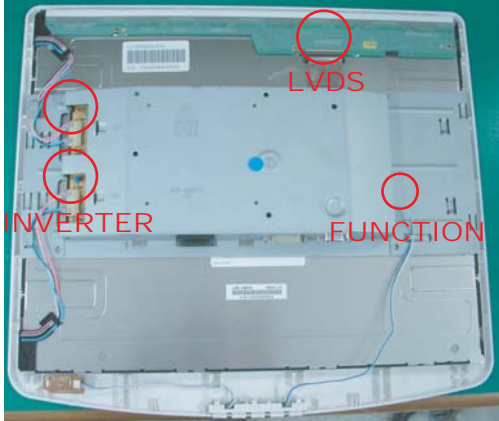
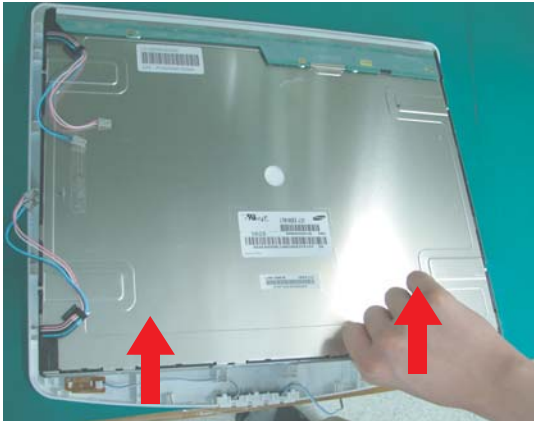
- ⚠ Cautions:**
1. Disassemble stand on a flat desk.
 2. Disconnect the monitor from the power source before disassembly.

Description	Picture Description
<p>1. Place a soft cloth on the desk and place the monitor on the cloth upside down. Remove the stand in the direction of the arrow.</p>	
<p>2. Turn the monitor so the front section is facing upwards. Remove the marked parts from the front cover, as shown in the figure below.</p>	
<p>3. Remove the marked part from the top edge of the front cover, as shown in the figure below.</p>	

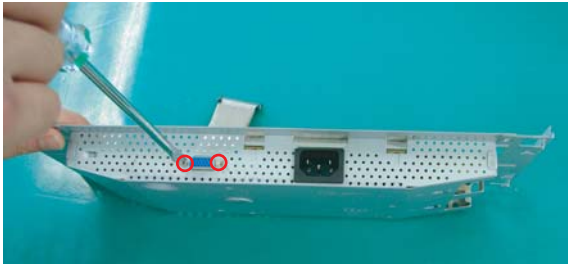
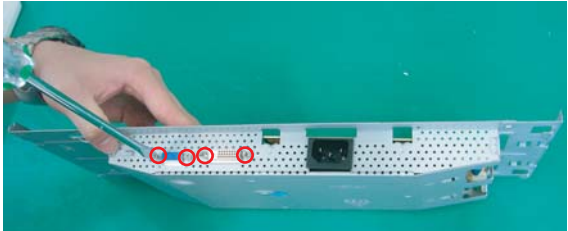
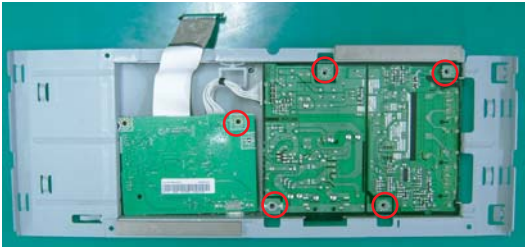
Description	Picture Description
<p>4. Remove the marked parts from both sides of the front cover, as shown in the figure below.</p>	
<p>5. Remove the marked part from the front cover, as shown in the figure below.</p> <p>Caution: Do not lift the front cover over position (1), which may cause damage to it.</p>	
<p>6. Turn the monitor so the back of it is facing upwards. Lift up and remove the back cover.</p>	
<p>7. Use the jig to remove the shield lamp. (Be careful Shield.)</p>	

Description	Picture Description
<p>8. Disconnect cables. (LVDS, INVERTER and FUNCTION cable)</p>	<p>17"</p>  <p>The image shows the back of a 17-inch LCD panel. Three cables are highlighted with red circles and labeled: 'LVDS' at the top center, 'INVERTER' on the left side, and 'FUNCTION' on the right side.</p>
	<p>19"</p>  <p>The image shows the back of a 19-inch LCD panel. Three cables are highlighted with red circles and labeled: 'LVDS' at the top center, 'INVERTER' on the left side, and 'FUNCTION' on the right side.</p>
<p>9. Lift up the LCD panel.</p>	 <p>A hand is shown lifting the LCD panel from the bottom edge. Two red arrows point upwards from the bottom edge of the panel, indicating the direction of movement.</p>
<p>10. LCD Panel</p>	 <p>The image shows the isolated LCD panel, which is a large, rectangular, silver-colored component with various connectors and a central circular hole.</p>

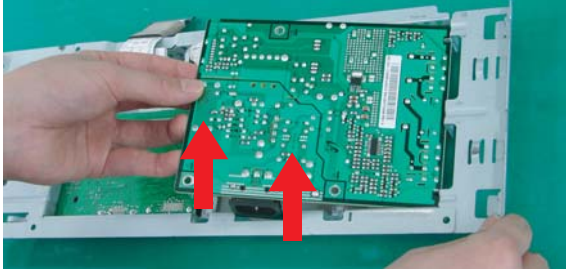
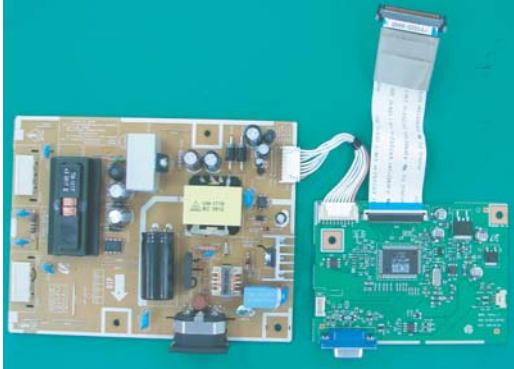
Description	Picture Description
<p>11.Remove screws. (17"=2 screws, 19"=4 screws)</p>	<p>17"</p>  <p>19"</p> 
<p>12. Remove 5 screws.</p>	
<p>13. Lift up the Bracket Support.</p>	

Description	Picture Description
<p>14. Lift up the Main PCB and IB Board.</p>	
<p>15. Main PCB and IB Board</p>	<p>17"</p>  <p>19"</p> 

11-2 Reassembly

Reassembly procedures are in the reverse order of disassembly procedures.

11-3 Stand

11-3-1 Installing the Stand



A: Monitor



B: Connecting pin





C: Stand



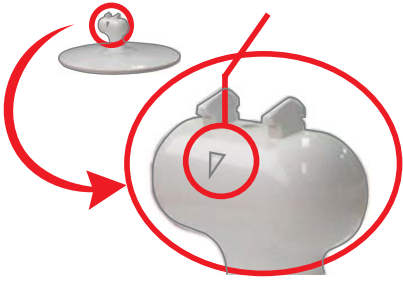

⚠ Caution

When lifting up or moving the monitor, do not lift the monitor upside down while holding only the stand, as this may cause the monitor to fall, leading to damage or personal injury.

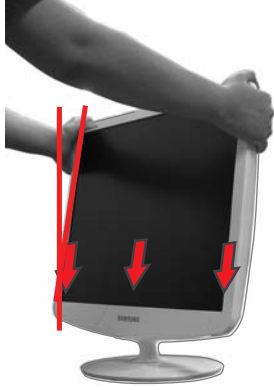
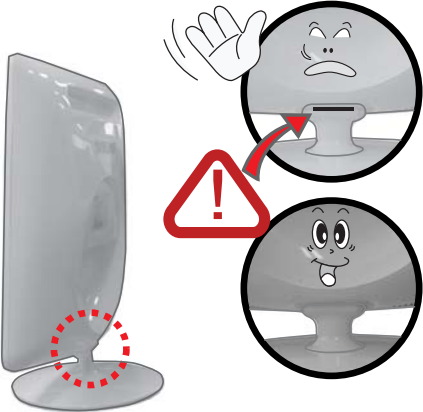
Description	Picture Description
<p>1. Insert the connecting pin into the stand.</p>	
<p>2. Stand the screw handles up and tighten the screws firmly by turning them.</p>	
<p>3. Place the screw handles back down.</p>	

Description	Picture Description
<p>4. Turn the stand so ▽ mark on the connecting pin is facing the front.</p>	
<p>4. Check the connecting part between the monitor and the stand.</p>	
<p>4. Tilt the monitor upwards at an angle of 5 ° to 10 ° so that the base is closer to you than the top. Then hold the monitor on the stand by its top parts and push them downwards.</p> <p>(You can assemble it more easily by pushing it down while wiggling it a little to the left and right.)</p>	
<p>5. When the monitor is assembled correctly, the straight groove line at the back of the connecting pin will not be visible when the monitor is erected at 90 ° .</p>	

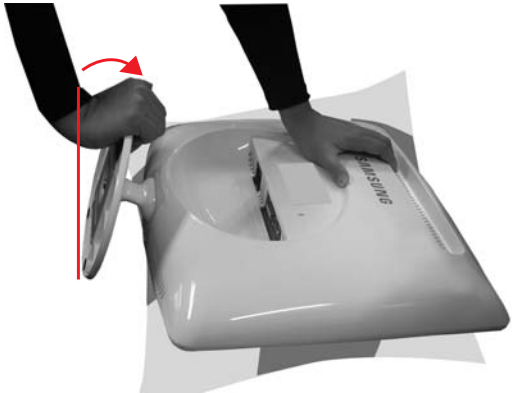
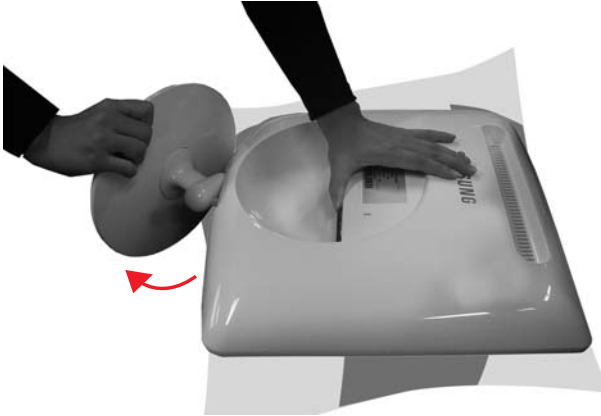
11-3-2 Removing the Stand

Description	Picture Description
<p>1. Place a soft cloth or cushion on the table and place the monitor with the front facing downwards.</p>	
<p>2. Hold the monitor and lean the stand upwards.</p>	
<p>3. Hold the monitor, and then twist the stand strongly to the left and pull it out.</p>	
<p>4. Stand the screw handles up and unfasten the screws by turning them.</p>	

Description	Picture Description
5. Remove the connecting pin from the stand.	 A black and white photograph showing a hand holding a small, circular, metallic component (the connecting pin) above a larger, circular, metallic component (the stand). The hand is positioned to the left, and the components are centered. The stand has a central hole and some markings on its surface.

Memo

12 PCB Diagram

12-1 Main PCB (17")

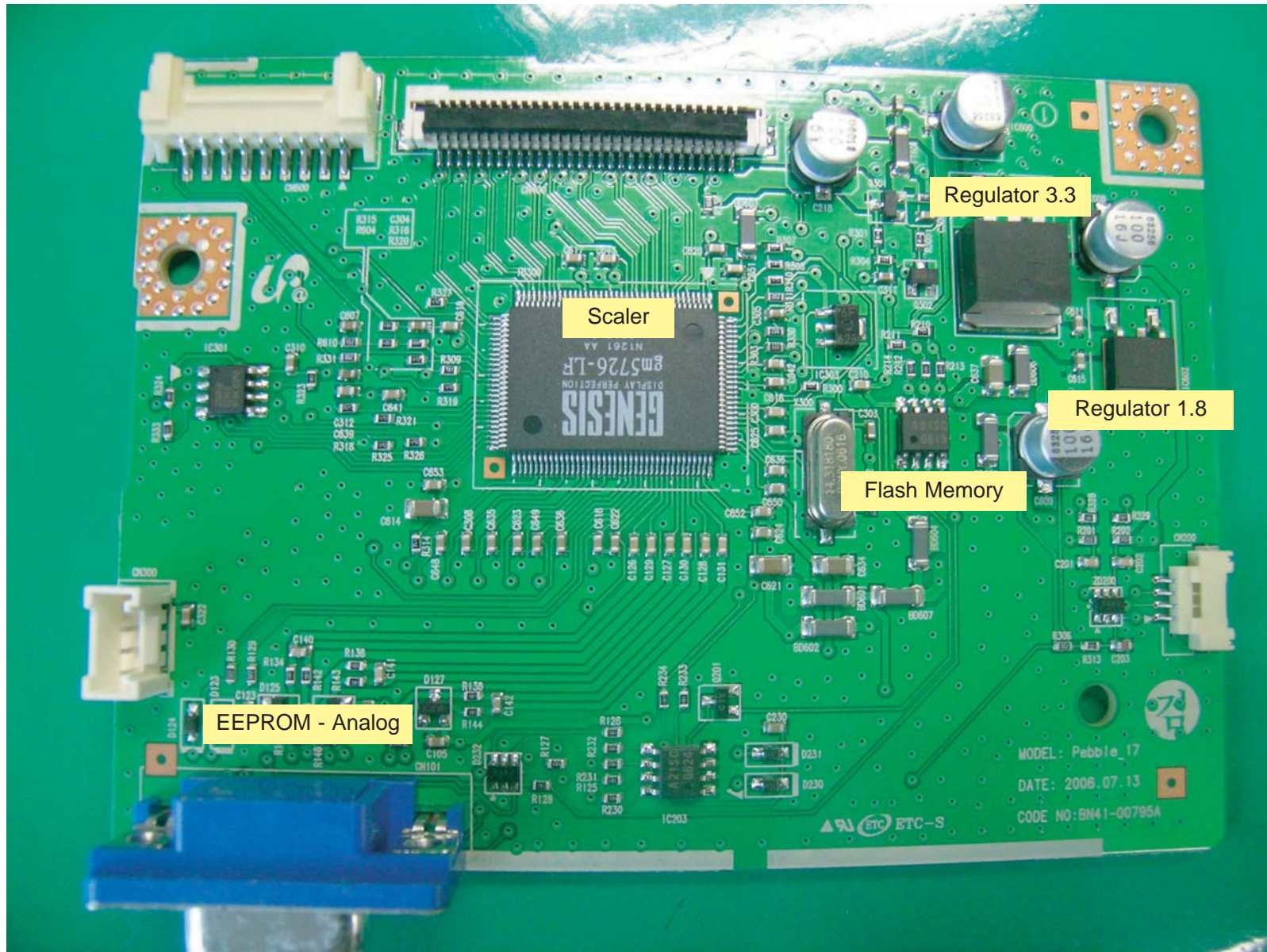

12-2 Main PCB (19")

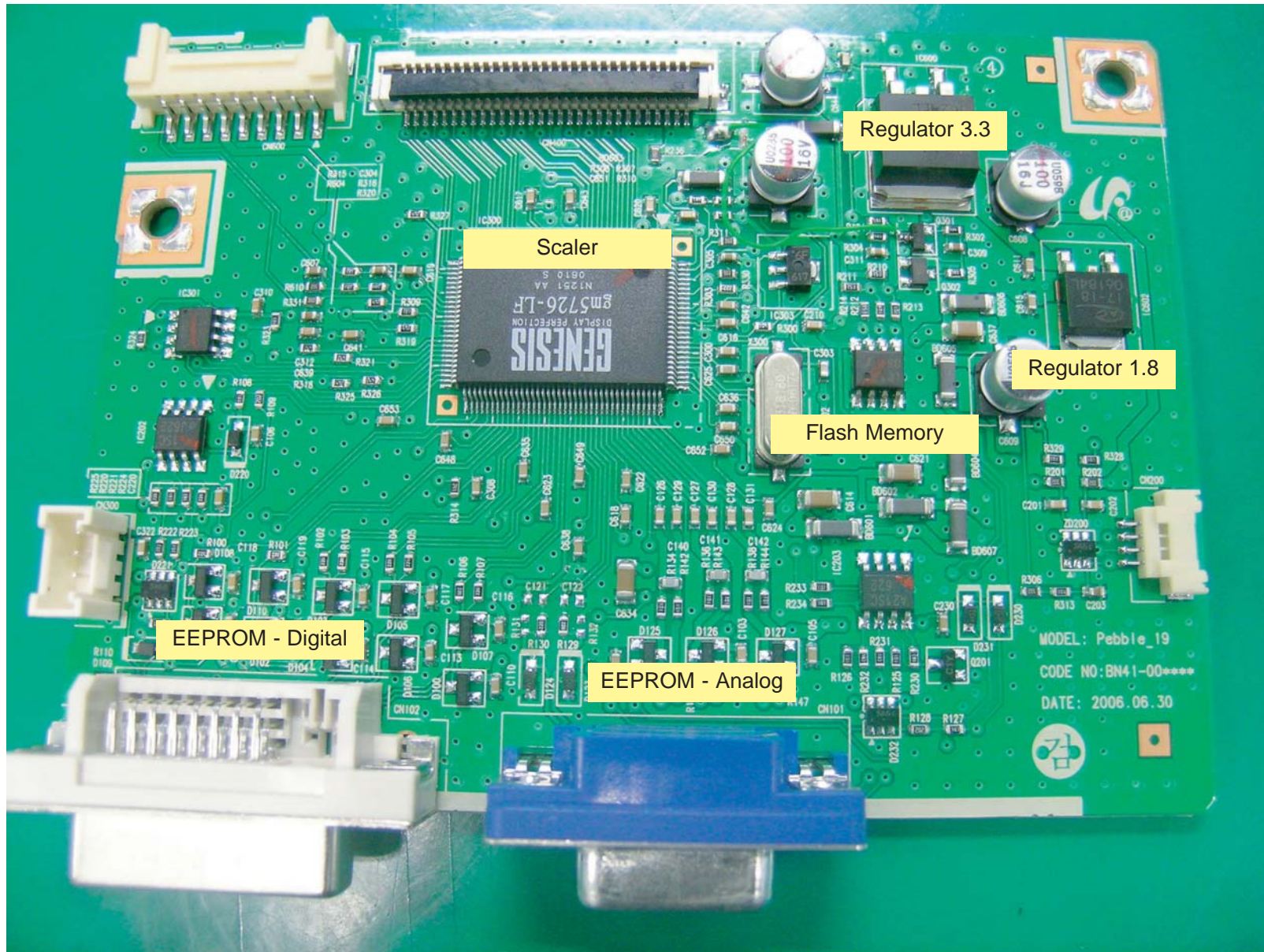

13 Circuit Descriptions

13-1 Overall Block Structure

13-1-1 Power Tree

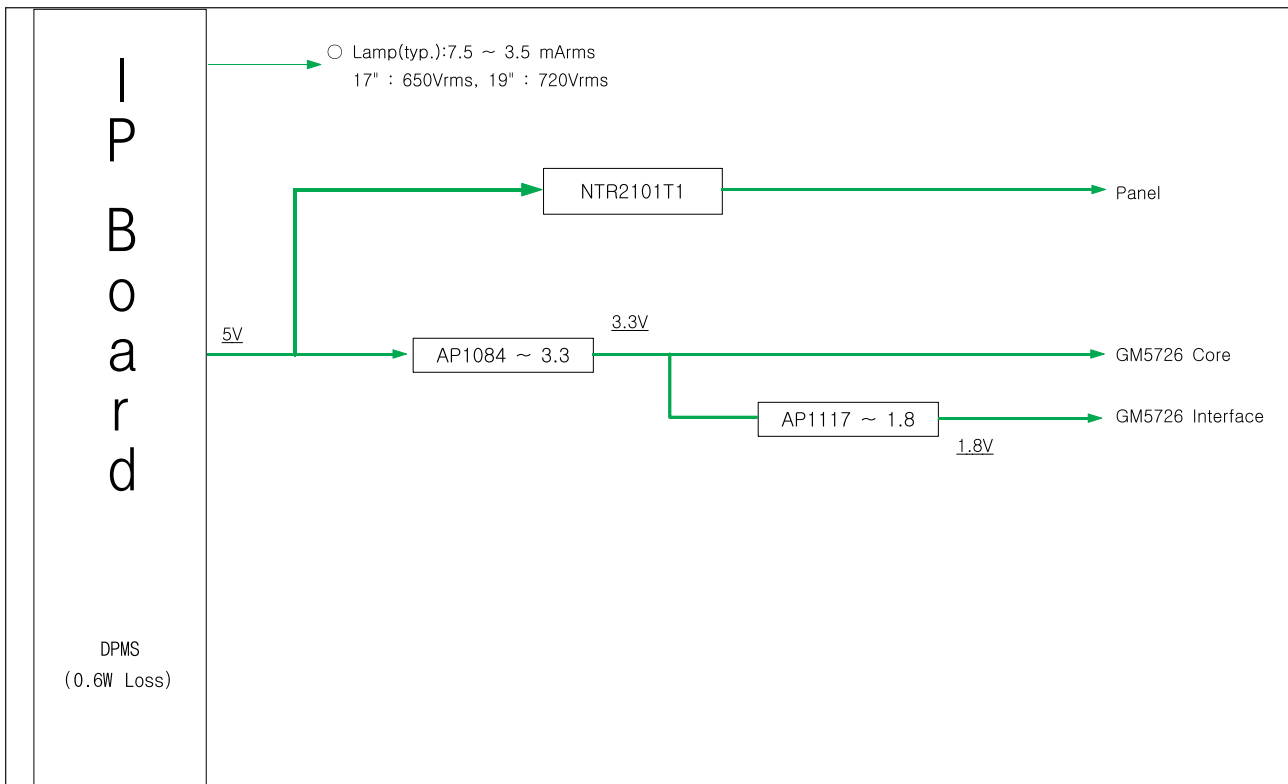

1. When the AD board is in DPMS state:

- 1.1 The IP has been designed so that it operates with a power consumption of less than 0.6W of.
- 1.2 The Scaler consumes power up to 37mA
- 1.3 The power to the panel is switched off

2. When the AD board is operating normally:

- 2.1 The maximum power consumption of the panel lamps is described below (It may vary depending on the panel manufacturer)
 - 17" : $4 \times (7.5\text{mA} \times 650\text{mVrms}) = 4 \times 4.9 = 19.6\text{W}$
 - 19" : $4 \times (7.5\text{mA} \times 720\text{mVrms}) = 4 \times 5.4 = 21.6\text{W}$
- 2.2 The power consumption of the Panel Control board is as follows: $5\text{V} \times 720\text{mA} = 3.6\text{W}$
- 2.3 The power consumption of the Scaler is as follows: $3.3\text{V} \times 245\text{mA} + 1.8\text{V} \times 300\text{mA} = 1.35\text{W}$

13-1-2 Main Board Parts

17"

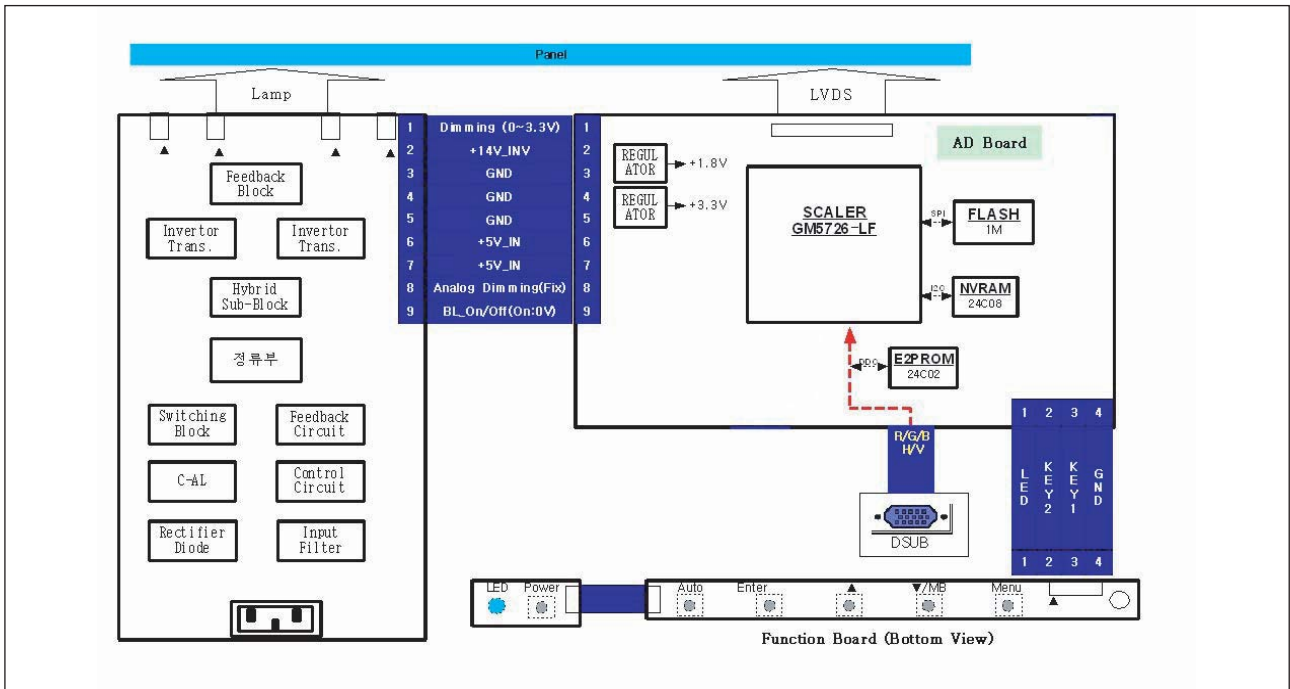

19"

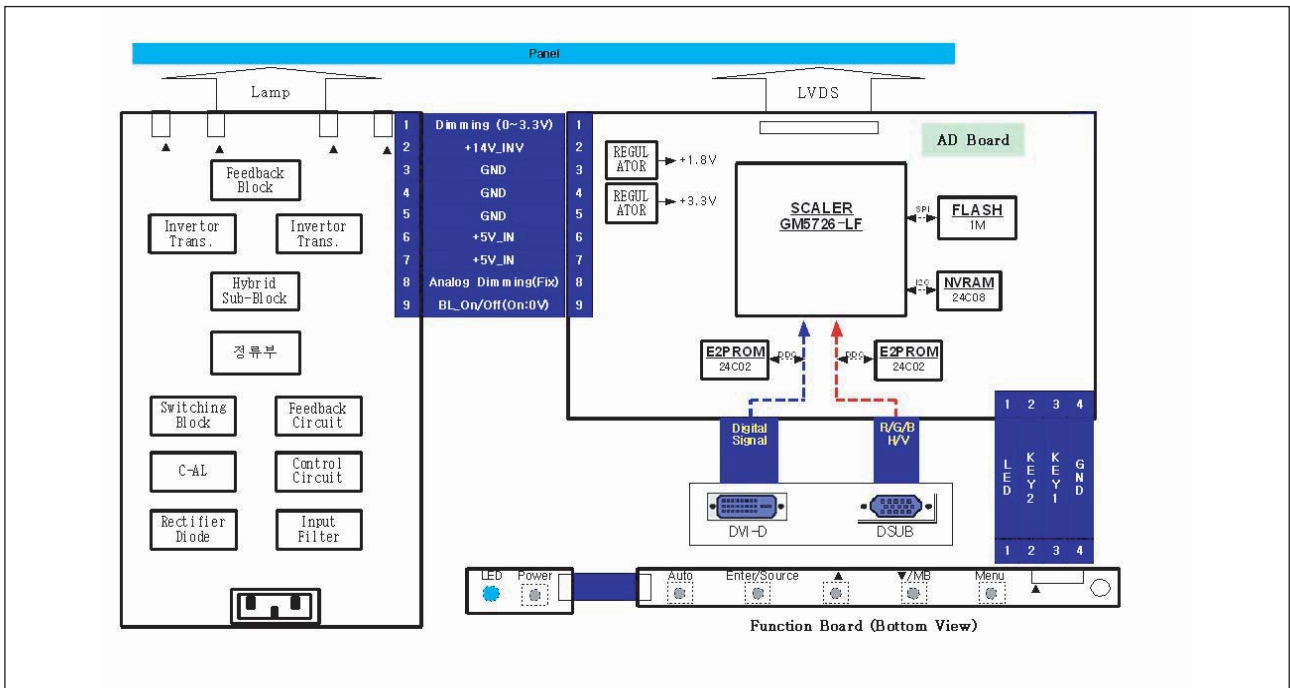

1. Inverter: A conversion device that converts DC rated voltage/current to high ones necessary for the panel lamp.
2. DC/DC(Regulator): General term for DC to DC converting devices.
The IP board receives 5V and outputs 1.8 or 3.3V that is supplied to the scaler (GM5726).
3. Power MosFET: The IP board receives 5V and outputs a lower voltage in DPMS mode and supplies the whole 5V for the panel operating board in normal conditions. In that case, the switching of Power MosFET is controlled by Micom.
4. Scaler: Receives the digital TMDS and analog R,G,B signals and convert them to proper resolutions using up- or down- scaling that are transferred to the panel in the LDVS formats.
5. Crystal(Oscillator): Use one 14.318MHz oscillator externally to supply power to both MCU and Scaler at the same time.
6. SCALER & EEPROM: I2C is a two-way serial bus of two lines that supports communications across the integrated circuits as well as between FLASH and EEPROM.
In particular, FLASH and Scaler (GM5726) use the SDR direct bus for mutual communications, which is an effective, speedy system because it allows 4 additional address/data lines compared to the old serial systems.
7. Function Key: A certain keystroke generates a certain electrical potential, which is transferred into ADC input port of the Scaler and then converted to a digital value by the A/D converter of the chip. The digital value (data) is a clue to which key is entered. In practical, the voltage levels are set as below.

13 Circuit Descriptions

13-1-3 IP BOARD BLOCK(POWER) Parts

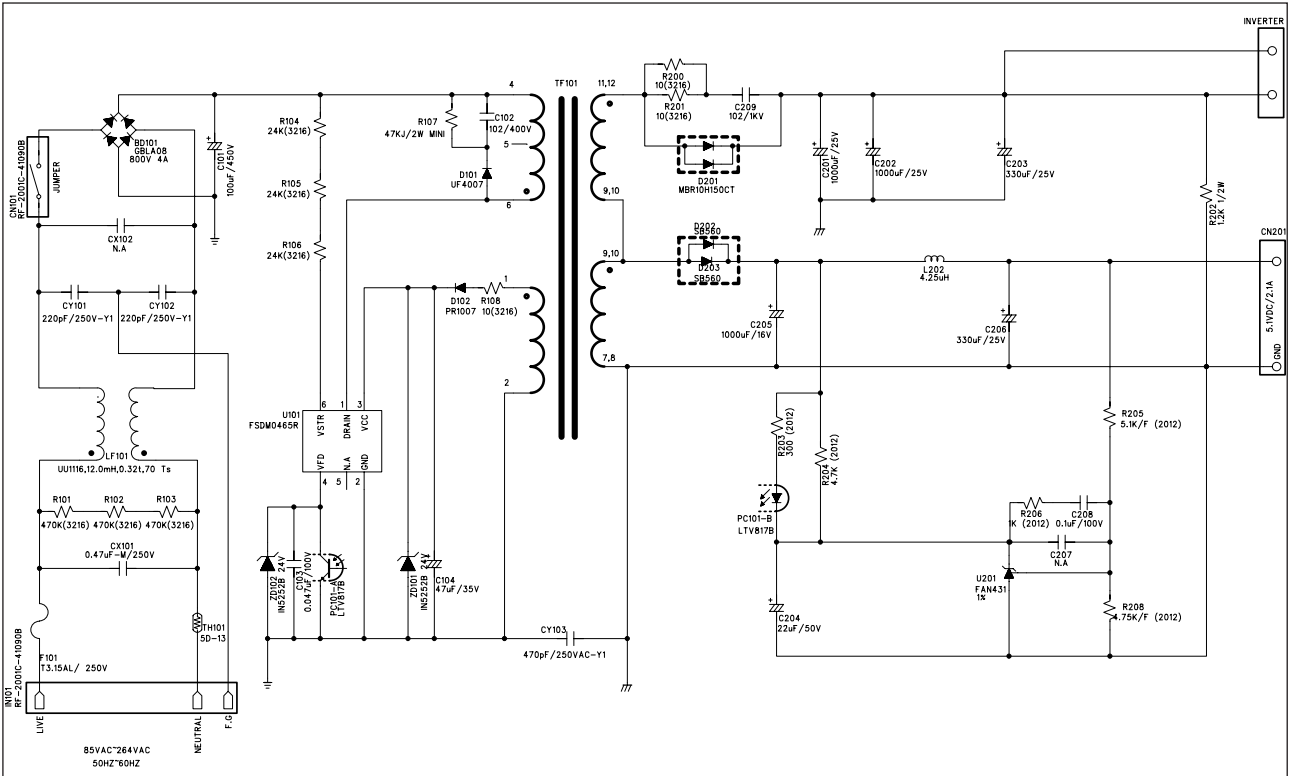

13-1-4 IP BOARD BLOCK(INVERTER) Parts

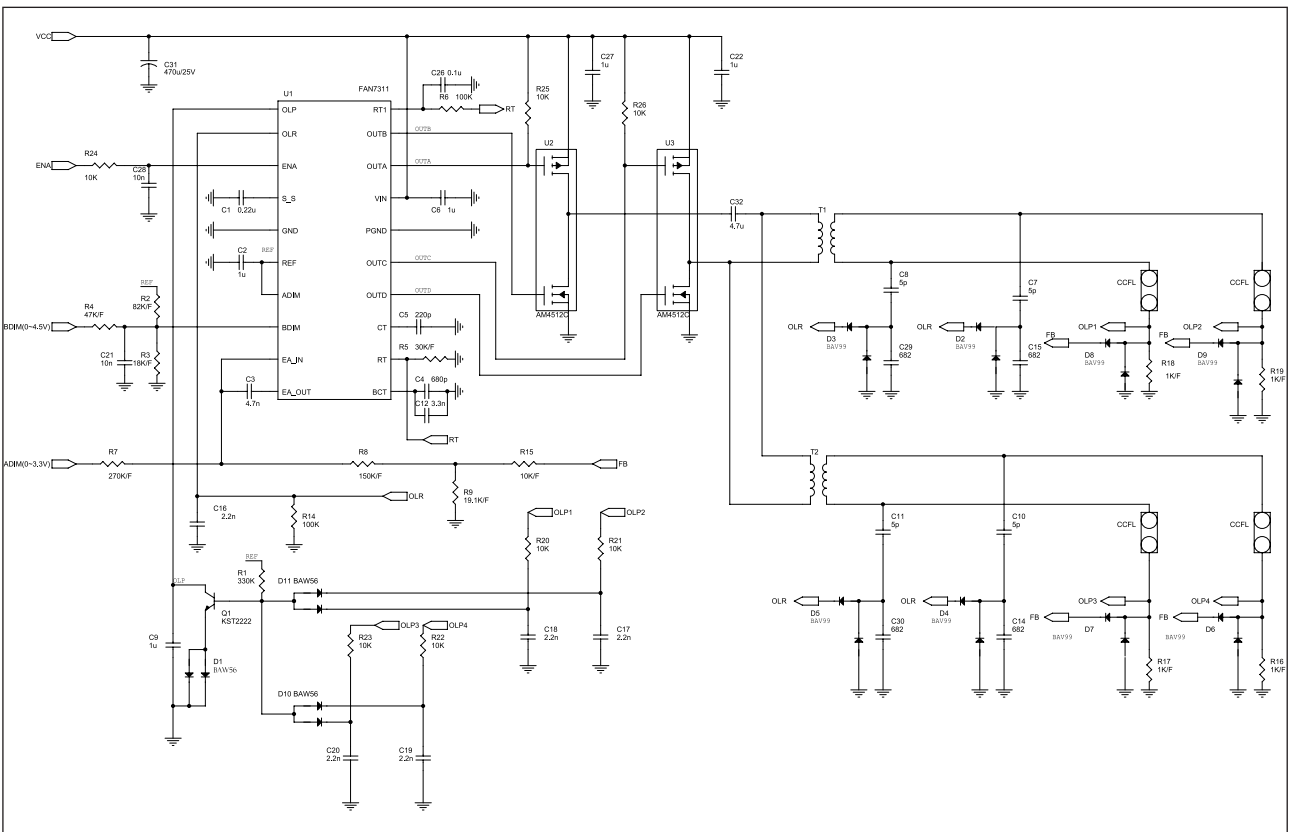

13-1-5 IP BOARD (inverter) PROTECTION Parts

Pebble INVERTER CONTROLLER FAN7310 have 2-way of the PROTECTION MODE.

1. OVP[Over Voltage Protection] : If the Voltage of the series capacitors C10 & C15 is over the 2.0V, the Inverter latched-off.[See the Picture1]

2. OLP[Over Load Protection] : If the inverter output harness is opened(No-output current), the base of the Q1 turns on and charge the C9 over 2V and then, the Inverter latched-off[See the Picture2]

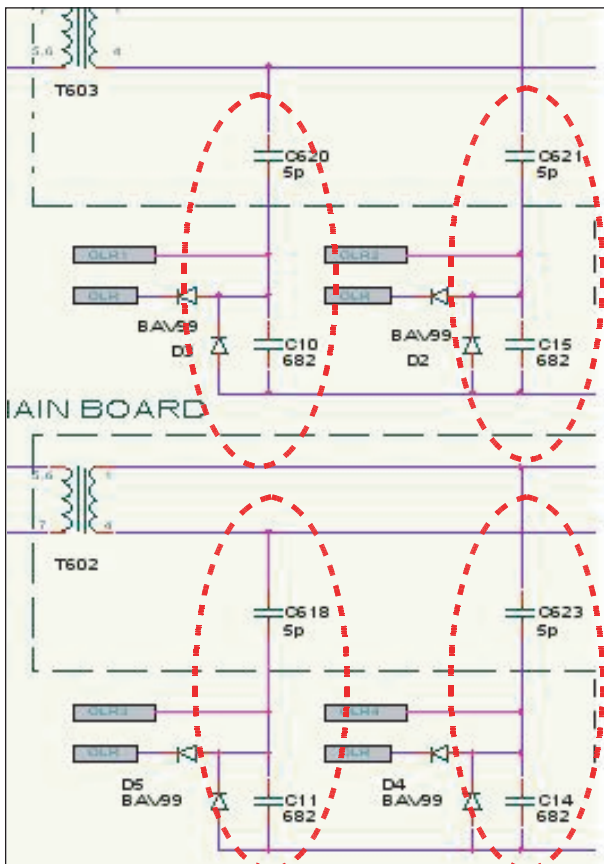

Figure 1.

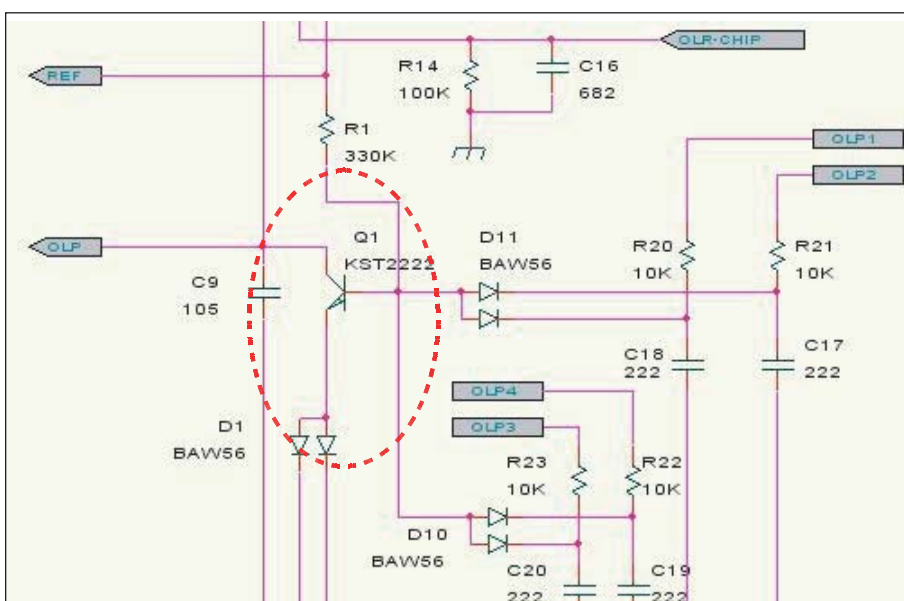
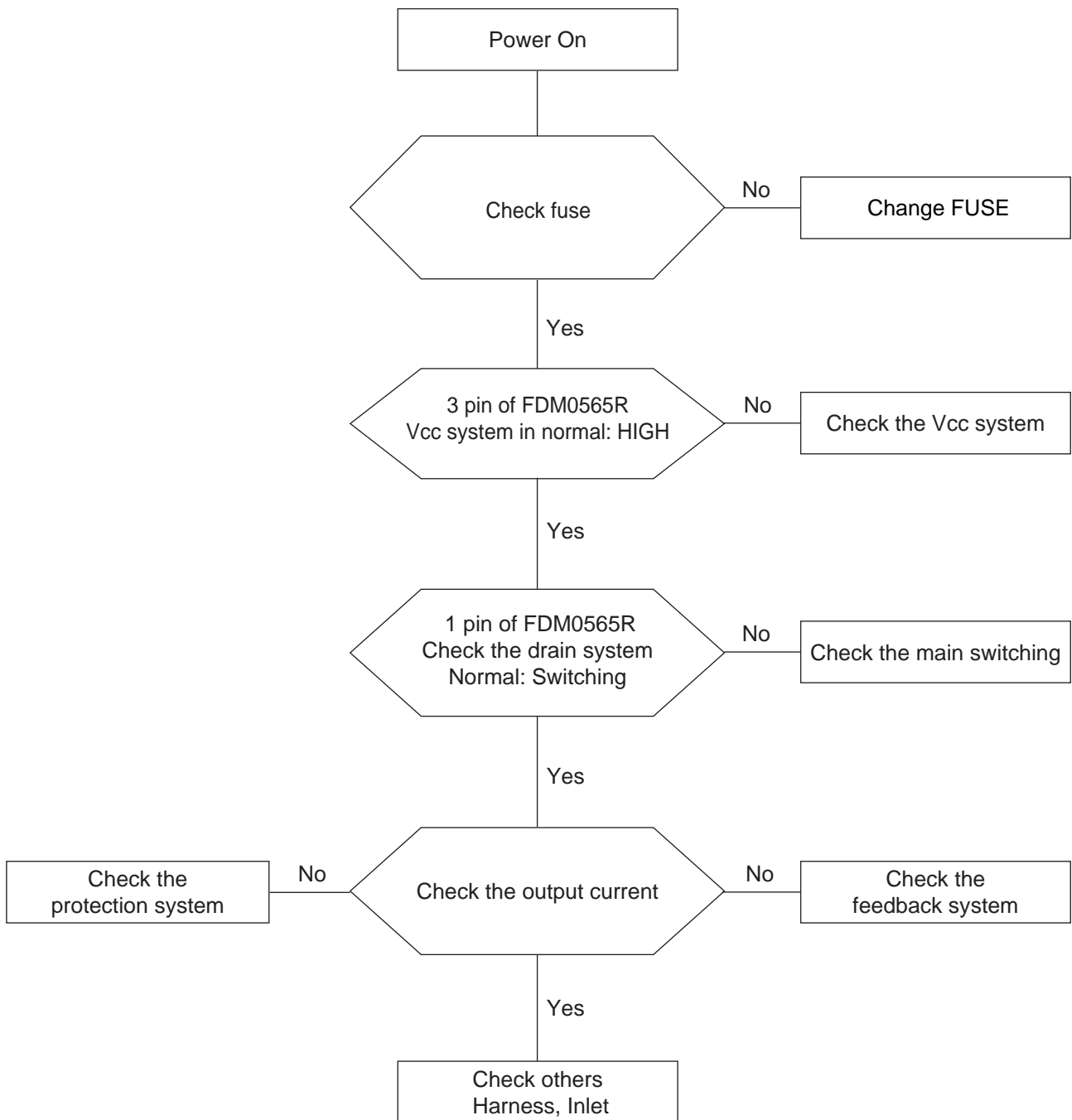

Figure 2.

13-2 Trouble Shooting

13-2-1 IP BOARD(Power)



13-2-1 IP BOARD(Inverter)

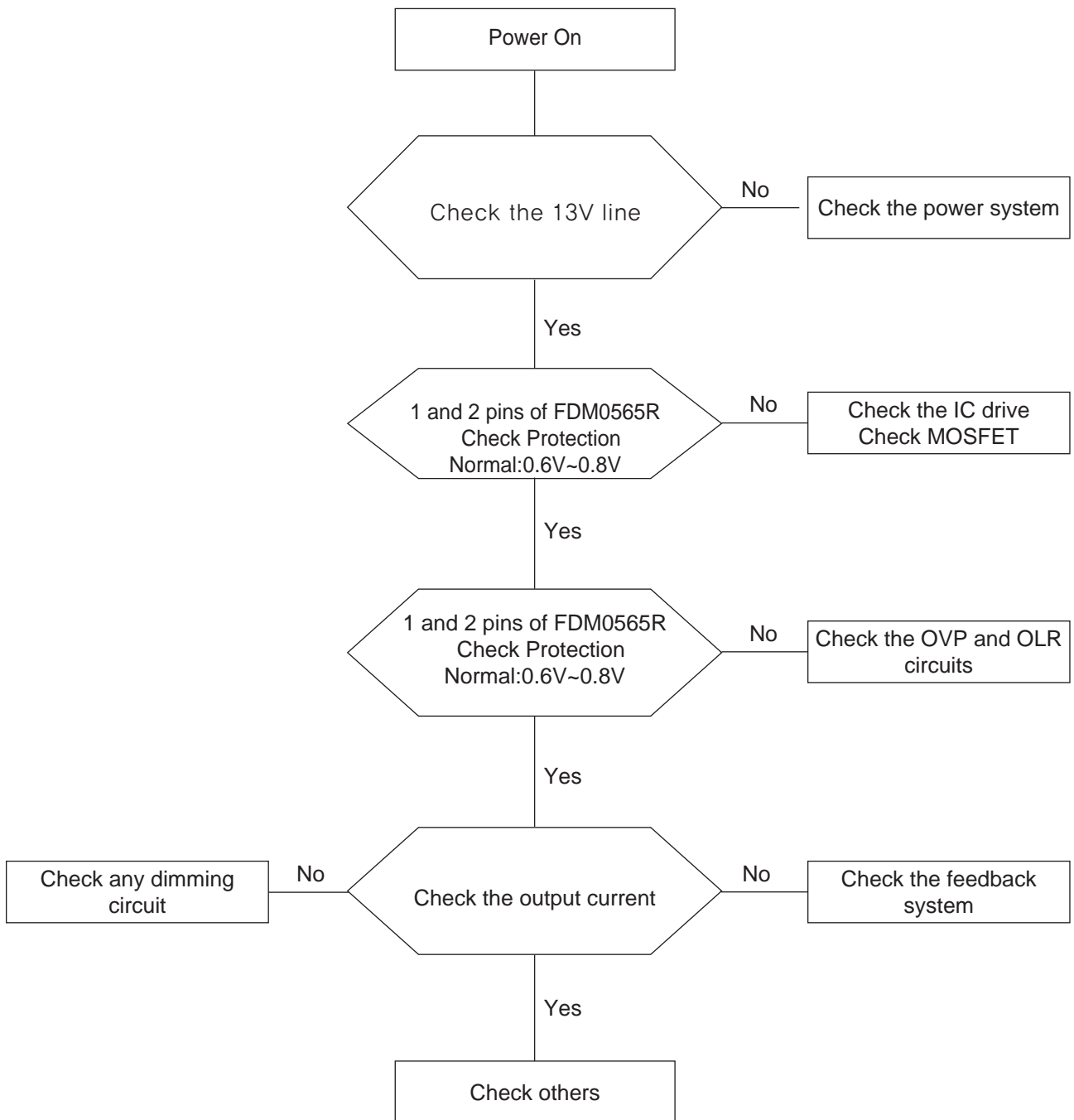

13-3 IP BOARD(Power) Schematic Diagrams

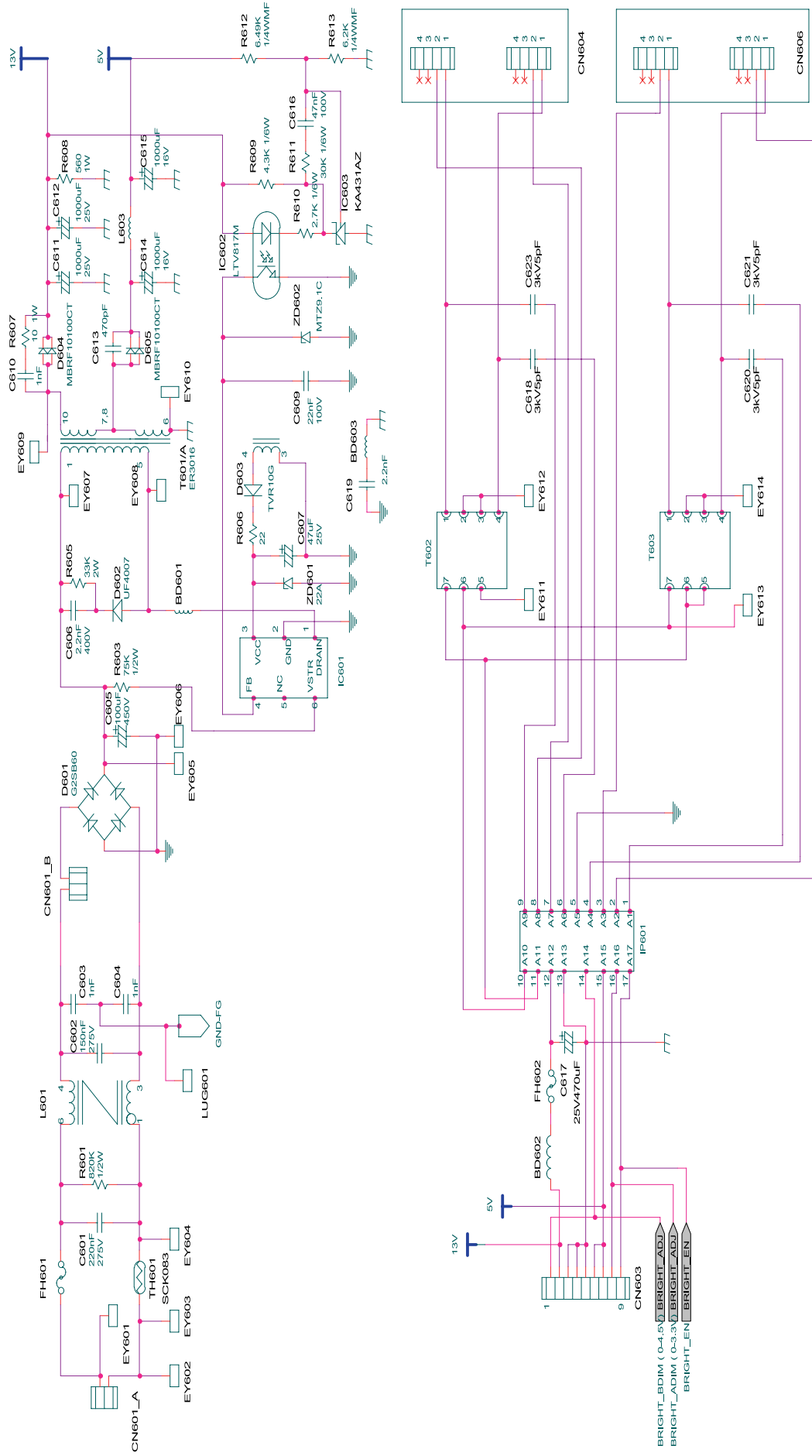

13-4 IP BOARD(Inverter) Schematic Diagrams

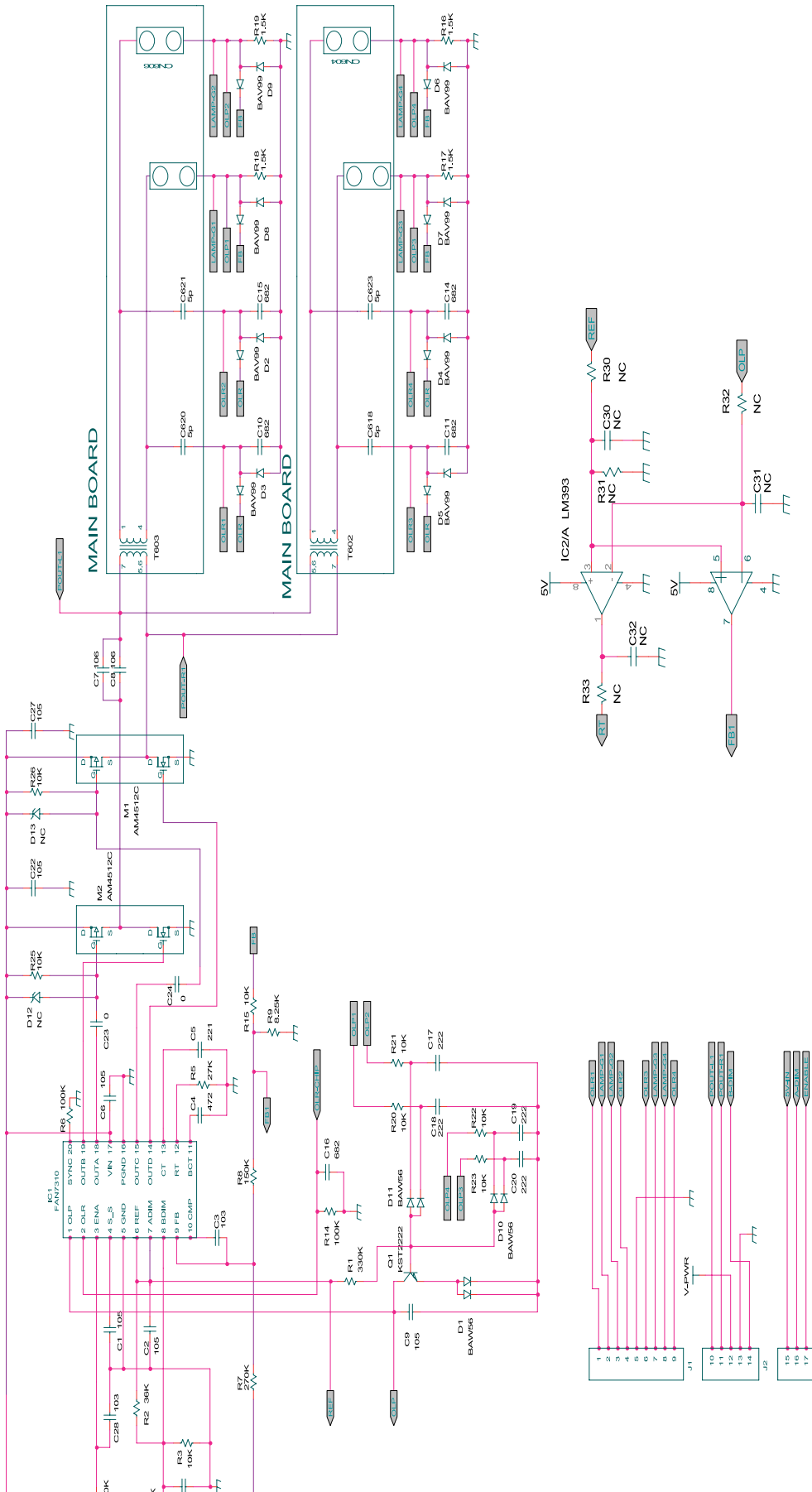

Memo

14 Reference Information

14-1 Technical Terms

-TFT-LCD

(Thin film Transistor Liquid Crystal Display)

ADC(Analog to Digital Converter)

This is a circuit that converts from analog signal to digital signals.

-PLL(Phase Locked Loop)

During progressing ADC, Device makes clock synchronizing HSYNC with Video clock

-Inverter

Device that supplies Power to LCD panel lamp. This device generates about 1,500~2,000V.

AC Adapter

Device that converts AC(90V~240V) to DC(+12V or 14V)

SMPS(Switching Mode Power Supply)

Switching Mode Power supply. This design technology is used to step up/down the input power by switching on/off

-FRC(Frame Rate Controller)

Technology that changes the number of frames displayed on screen per second.

TFT-LCD panel requires 60 frames per second.

This technology is needed to convert input image to 60 frames per second regardless input frame quantity.

-Image Scaler

Technology that converts an input resolution to another resolution.(ex. 640* 480 to 1024*768)

-Auto Configuration(Auto adjustment)

This is an algorithm to adjust monitor to optimum condition by pushing one key.

-OSD(On Screen Display)

Customers can easily control the screen settings using the OSD.

-FINE

The "Fine" adjustment is used to adjust visibility by controlling phase difference.

-COARSE

This adjustment adjusts the display by tuning Video clock and PLL clock.

-DVI (Digital Visual Interface)

This provides a high speed digital connection for visual data types that is display technology independent. This interface is primarily focused at providing a connection between a computer and its display device.

-L.V.D.S.(Low Voltage Differential Signaling)

A kind of transmission method for Digital.It can be used from Main PBA to Panel.

-T.M.D.S

(Transition minimized Differential Signaling)

a kind of transmission method for Digital.

It can be used from Video card to Main PBA.

-DDC(Display data channel)

It is a communication method between Host Computer and related equipment.

It enables Plug and Play between PC and Monitor.

-EDID

Extended Display Identification Data PC can recognize monitor information such as Product data, Product name,Display mode,Serial number and Signal source, etc Data is recognised via DDC Line linking PC and Monitor.

-Dot Pitch

The image on a monitor is composed of red, green and blue dots. The closer the dots, the higher the resolution. The distance between two dots of the same color is called the 'Dot Pitch'. Unit: mm

-Vertical Frequency

The screen must be redrawn several times per second in order to create and display an image for the

user. The frequency of this repetition per second is called Vertical Frequency or Refresh Rate. Unit: Hz
Example: If the same light repeats itself 60 times per second, this is regarded as 60 Hz.

-Horizontal Frequency

The time to scan one line connecting the right edge to the left edge of the screen horizontally is called Horizontal Cycle. The inverse number of the Horizontal Cycle is called Horizontal Frequency.
Unit: kHz

-Interlace and Non-Interlace Methods

Showing the horizontal lines of the screen from the top to the bottom in order is called the Non-Interlace method while showing odd lines and then even lines in turn is called the Interlace method. The Non-Interlace method is used for the majority of monitors to ensure a clear image. The Interlace method is the same as that used in TVs.

-Plug & Play

This is a function that provides the best quality screen for the user by allowing the computer and the monitor to exchange information automatically. This monitor follows the international standard VESA DDC for the Plug & Play function.

-Resolution

The number of horizontal and vertical dots used to compose the screen image is called 'resolution'. This number shows the accuracy of the display. High resolution is good for performing multiple tasks as more image information can be shown on the screen.

Example: If the resolution is 1280 x 1024 , this means the screen is composed of 1280 horizontal dots (horizontal resolution) and 1024 vertical lines (vertical resolution).

14-2 Pin Assignments

Pin No.	Sync Type	15-Pin D-Sub Signal Cable Connector		
		Separate	Composite	Sync-on-green
1		Red	Red	Red
2		Green	Green	Green + H/V Sync.
3		Blue	Blue	Blue
4		GND	GND	GND
5		DDC Return (GND)	DDC Return (GND)	DDC Return (GND)
6		GND-R	GND-R	GND-R
7		GND-G	GND-G	GND-G
8		GND-B	GND-B	GND-B
9		DDC Power Input (+5V)	DDC Power Input (+5V)	DDC Power Input (+5V)
10		Self Raster	Self Raster	Self Raster
11		GND	GND	GND
12		Bi-Dr Data (SDA)	Bi-Dr Data (SDA)	Bi-Dr Data (SDA)
13		H-Sync.	H/V-Sync.	Not Used
14		V-Sync.	Not Used	Not Used
15		DDC Clock (SCL)	DDC Clock (SCL)	DDC Clock (SCL)

Pin No.	Sync Type	24P DVI-D		
1		Rx2-	13	No Connection
2		Rx2+	14	+5V_M
3		GND	15	Self Raster
4		No Connection	16	+5V_M
5		No Connection	17	Rx0-
6		DDC Clock (SCL)	18	Rx0+
7		DDC Data (SDA)	19	NC
8		NC	20	No Connection
9		Rx1-	21	No Connection
10		Rx1+	22	NC
11		NC	23	RxC+
12		No Connection	24	RxC-

14-3 Timing Chart

This section of the service manual describes the timing that the computer industry recognizes as standard for computer-generated video signals.

Table 14-1 Timing Chart

Mode Timing	IBM		VESA						
	VGA2/ 70 Hz 720 x 400	VGA3/ 60 Hz 640 x 480	640/75 Hz 640x480	800/60 Hz 800x600	800/75 Hz 800x600	1024/60 Hz 1024x768	1024/75 Hz 1024x768	1280/60 Hz 1280x1024	1280/75 Hz 1280x1024
fH (kHz)	31.469	31.469	37.500	37.879	46.875	48.363	60.023	63.981	79.975
A μ sec	31.777	31.778	26.667	26.400	21.333	20.677	16.660	11.852	12.504
B μ sec	3.813	3.813	2.032	3.200	1.616	2.092	1.219	1.037	1.067
C μ sec	1.589	1.589	3.810	2.200	3.232	2.462	2.235	2.296	1.837
D μ sec	26.058	26.058	20.317	20.000	16.162	15.754	13.003	9.259	9.481
E μ sec	0.318	0.318	0.508	0.000	0.323	0.369	0.203	0.000	0.119
fV (Hz)	70.087	59.940	75.000	60.317	75.000	60.004	75.029	60.020	75.025
O msec	14.268	16.683	13.333	16.579	13.333	16.666	13.328	16.005	13.329
P msec	0.064	0.064	0.080	0.106	0.064	0.124	0.050	0.047	0.038
Q msec	0.858	0.794	0.427	0.607	0.448	0.600	0.466	0.594	0.475
R msec	13.155	15.761	12.800	15.840	12.800	15.880	12.795	15.630	12.804
S msec	0.191	0.064	0.027	0.0261	0.021	0.062	0.017	0.016	0.013
Clock Freq. (MHz)	28.322	26.175	31.500	40.000	49.500	75.000	78.750	108.000	135.000
Polarity H.Sync	Negative	Negative	Negative	Positive	Positive	Negative	Positive	Positive	Positive
V.Sync	Positive	Negative	Negative	Positive	Positive	Negative	Positive	Positive	Positive
Remark	Separate	Separate	Separate	Separate	Separate	Separate	Separate	Separate	Separate

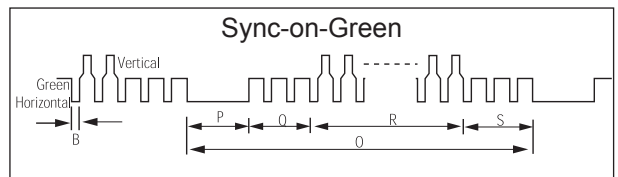
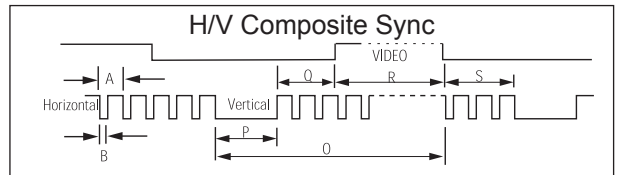
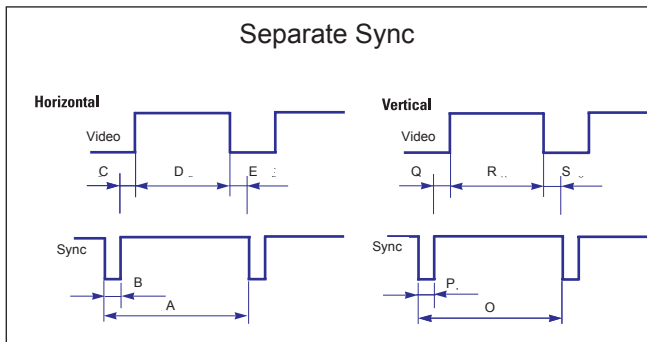

<p>A : Line time total B : Horizontal sync width P : Vertical sync width</p>	<p>O : Frame time total</p>
<p>C : Back porch D : Active time R : Active time</p>	<p>Q : Back porch</p>

14-4 Preset Timing Modes

-If the signal transferred from the computer is the same as the following Preset Timing Modes, the screen will be adjusted automatically. However, if the signal differs, the screen may go blank while the power LED is on. Refer to the video card manual and adjust the screen as follows.

Table 1. Preset Timing

Display Mode	Horizontal Frequency (kHz)	Vertical Frequency (Hz)	Pixel Clock (MHz)	Sync Polarity (H/V)
MAC, 640 x 480	35.000	66.667	30.240	-/-
MAC, 832 x 624	49.726	74.551	57.284	-/-
MAC, 1152 x 870	68.681	75.062	100.000	-/-
IBM, 640 x 350	31.469	70.086	25.175	+/-
IBM, 640 x 480	31.469	59.940	25.175	-/-
IBM, 720 x 400	31.469	70.087	28.322	-/+
VESA, 640 x 480	37.500	75.000	31.500	-/-
VESA, 640 x 480	37.861	72.809	31.500	-/-
VESA, 800 x 600	35.156	56.250	36.000	+, -/+, -
VESA, 800 x 600	37.879	60.317	40.000	+/+
VESA, 800 x 600	46.875	75.000	49.500	+/+
VESA, 800 x 600	48.077	72.188	50.000	+/+
VESA, 1024 x 768	48.363	60.004	65.000	-/-
VESA, 1024 x 768	56.476	70.069	75.000	-/-
VESA, 1024 x 768	60.023	75.029	78.750	+/+
VESA, 1152 x 864	67.500	75.000	108.00	+/+
VESA 1280 x 960	60.000	60.000	108.00	+/+
VESA, 1280 x 1024	63.981	60.020	108.00	+/+
VESA, 1280 x 1024	79.976	75.025	135.00	+/+

Horizontal Frequency

The time to scan one line connecting the right edge to the left edge of the screen horizontally is called Horizontal Cycle and the inverse number of the Horizontal Cycle is called Horizontal Frequency. Unit: kHz

Vertical Frequency

Like a fluorescent lamp, the screen has to repeat the same image many times per second to display an image to the user. The frequency of this repetition is called Vertical Frequency or Refresh Rate. Unit: Hz

14-5 Panel Description

Maker	VENDOR P/N	PANEL_CODE	PANEL_ABB	STICKER_CODE	Remarks
SEC	LT140X1-002	BN07-00004A	SA	BN68-00239H	-
SEC	LT150XS-L01	BN07-00009A	SB		-
SEC	LT150XS-L01-B	BN07-00022A	SC		-
SEC	LTM150XS-L02	BN07-00005A	SD		-
SEC	LT181E2-132	BN07-00001A	SE		-
SEC	LT150XS-T01	BN07-00010A	SF		-
SEC	LTM181E3-132	BN07-00019A	SG		-
SEC	LT170E2-131	BN07-10001D	SH		-
SEC	LT181E2-131	BN07-10001E	SJ		-
SEC	LTM170E4-L01	BN07-00018A	SK		-
SEC	LTM240W1-L01	BN07-00015A	SL		-
SEC	LTM213U3-L01	BN07-00016A	SM		-
SEC	LTM150XH-L01	BN07-00026A	SN		-
SEC	LTM150XH-L03	BN07-00027A	SP		-
SEC	LTM150XS-L01	BN07-00032A	SQ		DELL(ZPD)
SEC	LTM181E4-L01	BN07-00034A	SR		PVA
SEC	LTM170EH-L01	BN07-00036A	SS		TN
SEC	LTM170E5-L01	BN07-00037A	SU		PVA
SEC	LTM150XH-L11	BN07-00041A	SV		-
SEC	LTM213U4-L01	BN07-00039A	SW		PVA
SEC	LTM150XH-L01(ZPD)	BN07-00045A	SX		ZPD
SEC	LTM150XH-L04	BN07-00046A	SY		"New panel with high brightness"
SEC	LTM170W1-L01	BN07-00047A	SZ		Panel for TV
SEC	LTM150XH-L06	BN07-00053A	EA		Panel for TV/ High luminance for 450cd _ SONY&EOS Team Panel for TV
SEC	LTM153W1-L01	BN07-00054A	EB		Use NIKE MODEL
SEC	LTM170EH-L05	BN07-00055A	EC		Panel EOS proj. for high brightness of 17" EH-L05
SEC	LTM170E5-L03	BN07-00056A	ED		Dell 1702FP pro. E4. EH mechanicalCompatible
SEC	LTM190E1-L01	BN07-00057A	EE		DELL 1900 FP
SEC	LTM181E5-L01	BN07-00061A	EF		18" narrow bezel GH18PS
SEC	LTM150XP-L01	BN07-00065A	EG		AMLCD PVA PANEL
SEC	LTM240W1-L02	BN07-00062A	EH		Panel for 15" Wide TV
SEC	LTM170EU-L01	BN07-00071A	EJ		Slim design, TN
SEC	LTM170E5-L04	BN07-00072A	EK		E5-L04 6 bits FRC... for IBM
SEC	LTA220W1-L01	BN07-00074A	EL		Panel for 22" TV
SEC	LTM170E6-L02	BN07-00075A	EM		AMLCD Narrow & slim design 17" PVAmode
SEC	LTM170W1-L01	BN07-00082A	EN		LTM170W1-L01 ZPD panel
SEC	LTM170EH-L01	BN07-00080A	EP		LTM170EH-L01 ZPD panel
SEC	LTM170E5-L01	BN07-00081A	EQ		LTM170E5-L01 ZPD panel
SEC	LTM170EH-L05	BN07-00083A	ER		LTM170EH-L05 ZPD panel
SEC	LTM170E5-L03	BN07-00084A	ES		LTM170E5-L03 ZPD panel
SEC	LTM170EU-L01	BN07-00085A	ET		LTM170EU-L01 ZPD panel
SEC	LTM170E5-L04	BN07-00086A	EU		LTM170E5-L04 ZPD panel
SEC	LTM170E6-L02	BN07-00087A	EV		LTM170E6-L02 ZPD panel
SEC	LTM150XH-L06	BN07-00091A	EW		"Color coordinates change for LCD TV"
SEC	LTM153W1-L01	BN07-00092A	EX		AMLCD WIDE 15",9/10
SEC	LTM170W1-L01	BN07-00100A	EY		"Color Coordinates change code management"
SEC	LTM170EH-L05	BN07-00097A	EZ		"LTM170E5-L05 Color Coordinates Change Panel Code"
SEC	LTA400W1-L01	BN07-00109A	S1		"PANEL of AMLCD 40"" TV"
SEC	LTM153W1-L01	BN07-00110A	S2		"Color coordinates change 0.280/0.290, 10000k & ZPD Panel"
SEC	LTM150XH-L06	BN07-00111A	S3		"Color coordinates change 0.280/0.290, 10000k & ZPD Panel"
SEC	LTM170W1-L01	BN07-00112A	S4		"Color coordinates change 0.280/0.290, 10000k & ZPD Panel"
SEC	LTM170EH-L05	BN07-00113A	S5		"Color coordinates change 0.280/0.290, 10000k & ZPD Panel"
SEC	LTM220W1-L01	BN07-00114A	S6		"ZPD Panel for AMLCD 22"" TV"

Maker	VENDOR P/N	PANEL_CODE	PANEL_ABB	STICKER_CODE	Remarks
SEC	LTM150XH-L06	BN07-00117A	S7		"ZPD Panel code"
SEC	LTM153W1-L01	BN07-00118A	S8		"ZPD Panel code"
SEC	LTM170WP-L01	BN07-00119A	S9		"PVA Panel for NIKE"
SEC	LTM213U4-L01	BN07-00039A	E1		21.3" NARROW
SEC	LTA260W1-L01	BN07-00121A	E2		VENUS
SEC	LTA220W1-L01	BN07-00074B	E3		"Panel B-level panel code for 22" TV Panel "
SEC	LTA320W1-L01	BN07-00108A	E4		"Panel for AMLCD 32" TV"
SEC	LTM213U4-L01	BN07-00124A	E5		NARROW BEZEL 21 " PANEL
SEC	LTM170E6-L04	BN07-00129A	E6		"HIGHLAND 17" LOW PANEL (Panel only for TCO03)"
SEC	LTM190E1-L01	BN07-00088A	E7		LTM190E1-L01 ZPD panel
SEC	M150X4-L06	BN07-00137A	E8		15" Narrow & Slim panel
SEC	LTA170V1	BN07-00139A	E9		"17" Panel for Muse 4:3 VGA TV"
SEC	LTM190E1-L02	BN07-00128A	E10		"New Panel from AMLCDI, Specification : 6bit Driver IC"
SEC	LTM170EX-L01	BN07-00143A	E11		"Development new Panel from AMLCD"
SEC	LTM170E8-L01	BN07-00144A	E12		"Development new Panel from AMLCD"
SEC	LTM170E6-L04	BN07-00129B	E13		"ZPD panel for AMLCD (Panel only for TCO03)"
SEC	LTA320W1-L02	BN07-00108B	E14		"Creat B-level Panel code for AMLCD 32" TV"
SEC	LTM190E1-L03	BN07-00151A	E15		"Development new 19" Panel form AMLCD (Panel only for TCO03)"
SEC	LTM240W1-L03	BN07-00134A	E16		"AMLCD 24" panel development"
SEC	LTM190E1-L02	BN07-00128B	E17		"New Panel from AMLCD, Specification : 6bit Driver IC(ZPD)"
SEC	LTM190E4-L01	BN07-00145A	E18		"AMLCD 24" new panel development"
SEC	LTM170E8-L01	BN07-00158A	E19		"ZPD code derivation"
SEC	LTM170EX-L01	BN07-00159A	E20		"ZPD code derivation"
SEC	LTM190E1-L03	BN07-00151B	E21		"Creat new panel code for AMLCD 19" (Panel only for TCO03)"
SEC	LTA460H1-L01	BN07-00157A	E22		"creat panel code for AMLCD 46" TV "
SEC	LTM170EU-L11	BN07-00160A	E23		"creat new panel code for AMLCD 17" (Panel only for TCO03)"
SEC	LTM240W1-L03	BN07-00134B	E24		"24" panel ZPD code derivation"
SEC	LTM190E4-L01	BN07-00145B	E25		"AMLCD 19" ZPD Panel code derivation"
SEC	LTM240W1-L03	BN07-00134B	E26		24" panel ZPD code derivation
SEC	LTM150XO-L01	BN07-00164A	E27		AMLCD 15" XO-L01 new panel development
SEC	LTM150XO-L01	BN07-00164B	E28		AMLCD 15" XO-L01 ZPD code derivation
SEC	LTM170EU-L11	BN07-00160B	E29		AMLCD 17" NEW panel code derivation
SEC	LTA320W2-L01	BN07-00172A	SPZ		AMLCD 32" NEW panel
SEC	LTM213U4-L01	BN07-00124B	SPZ		21.3" Narrow PANEL ZPD Panel derivation
SEC	LTM170EU-L11	BN07-00189A	STH		AMLCD EU-L11 Pb free panel code derivation
SEC	LTM170EU-L11	BN07-00189B	STZ		AMLCD EU-L11 Pb free panel ZPD code derivation
SEC	LTM240W1-L04	BN07-00188A	SPH		24" A-DCC new panel development
SEC	LTM190EX-L01	BN07-00191A	STH		AMLCD 19" TN new Panel
SEC	LTM190EX-L02	BN07-00191B	STZ		AMLCD 19" TN new Panel ZPD derivation
SEC	LTA230W1-L02	BN07-00184A	SPZ		AMLCD 23" 16:9 new Panel
SEC	LTA260W2-L01	BN07-00185A	SPZ		AMLCD 26" 16:9 new Panel
SEC	LTM240M1-L01	BN07-00195A	SPH		24" panel with high brightness development
SEC	LTA400W2-L01	BN07-00186A	SPZ		AMLCD 40" 16:9 new Panel
SEC	LTM150XO-L01	BN07-00197A	STH		AMLCD 15" XO-L01 Pb free panel code
SEC	LTM150XO-L01	BN07-00197B	STZ		AMLCD 15" XO-L01 Pb free panel ZPD code
SEC	LTM170EU-L21	BN07-00202A	STZ		AMLCD EU-L21 ZPD new code derivation
SEC	LTA460W2-L03	BN07-00187A	SPZ		BEETOVEN 46"ZPD new Panel
CPT	CLAA150XG09	BN07-00141A	PA		CPT 15" Monitor new panel development
CPT	CLAA170EA02	BN07-00148A	PB		17" CPT NEW development panel
CPT	CLAA170EA02	BN07-00148B	PC		17" CPT ZPD panel code derivation
CPT	CLAA150XG09	BN07-00141B	PTZ		"CPT 15" panel ZPD code derivation (GOYA-PJT)"
CPT	CLAA150XP01	BN07-00173A	PTH		CPT 15" PSWG code derivation
CPT	CLAA150XP01	BN07-00173B	PTZ		CPT 15" PSWG panel ZPD code

14 Reference Information

Maker	VENDOR P/N	PANEL_CODE	PANEL_ABB	STICKER_CODE	Remarks
CPT	CLAA170EA07	BN07-00174A	PTH		"CPT 17"" PSWG panel code derivation?
CPT	CLAA170EA07	BN07-00174B	PTZ		CPT 17"""" PSWG type new Panel code""""
CPT	CLAA170EA07	BN07-00174B	PTZ		CPT 17" PSWG type new Panel code
TOSHIBA	LTM15C419(A)	BN07-00002A	TA		-
TOSHIBA	LTM15C423(B)	BN07-00006A	TB		-
TOSHIBA	LTM18C161	BN07-00008A	TC		-
TOSHIBA	LTM15C443	BN07-00031A	TD		-
TOSHIBA	LTM15C458	BN07-00043A	TE		-
TOSHIBA	LTM15C458S	BN07-00077A	TF		"TSB 15"" high brightness Panel"
TOSHIBA	LTM15C458	BN07-00078A	TG		Toshiba ZPD panel
TOSHIBA	LTM15C458S	BN07-00099A	TH		TSB LTM15C458S (ZPD)
HANNSTAR	HSD150MX41A(A)	BN07-00020A	NA		"TTL type"
HANNSTAR	HSD150MX12	BN07-00030A	NB		"TTL type"
HANNSTAR	HSD170ME13	BN07-00180A	NTH		Hannstar 17" TN new panel development
HANNSTAR	HSD170ME13	BN07-00180B	NTZ		Hannstar 17" TN new panel development ZPD code derivation
TORISAN	TM150XG-22L03(A)	BN07-00021A	RA		-
TORISAN	TM150XG-26L06	BN07-00042A	RB		-
TORISAN	TM181SX-76N01	BN07-00048A	RC		-
TORISAN	TM150XG-26L06	BN07-00059A	RD		15" XGA TN MODE(ZPD)
TORISAN	TM290WX-71N31	BN07-00063A	RE		"RS24NS (TORISAN 29"" NEW PANEL)"
TORISAN	TM396WX-71N31	BN07-00064A	RF		"RS24NS (TORISAN 40"" NEW PANEL)"
TORISAN	TM150XG-26L09	BN07-00073A	RG		"Panel for 15"" TV"
TORISAN	TM150XG-26L10	BN07-00089A	RH		"L10(change except D/IC) ZPD"
TORISAN	TM150XG-26L10	BN07-00090A	RJ		L10 NORMAL
TORISAN	TM190SX-70N01	BN07-00098A	RK		Torisan 19" Panel
TORISAN	TM181SX-76N01	BN07-00106A	RL		ZPD Panel code
TORISAN	TM190SX-70N01	BN07-00107A	RM		ZPD Panel code
TORISAN	TM290WX-71N31	BN07-00115A	RN		"Color Coordinates change panel for TORISAN 29"" TV"
TORISAN	TM396WX-71N31	BN07-00116A	RP,Q		"Color Coordinates change panel for TORISAN 40"" TV"
TORISAN	TM220WX-71N31	BN07-00125A	RR		"Development TORISAN 22"" TV PANEL (ZPD)"
TORISAN	TM220WX-71N31	BN07-00127A	RS		"Development TORISAN 22"" TV PANEL (HPD)"
TORISAN	TM396WX-71N32A	BN07-00150A	RT		120V inverter Exclusive panel
TORISAN	TM190SX-70N02	BN07-00154A	RMH		Torisan 6bit panel code Derivation
TORISAN	TM190SX-70N02	BN07-00154B	RMZ		Torisan 6bit panel code Derivation
SHARP	LQ181E1DG11(A)	BN07-10001C	PA		-
SHARP	LQ150X1LW71	BN07-00067A	PB		SHARP 15" PVA PANEL
HITACHI	TX38D12VC0CAA(A)	BN07-00003A	HA		-
HITACHI	TX43DVCOCAB	BN07-00060A	HB		17" SXGA PVA MODE
HITACHI	TX43D15VC0CAB	BN07-00101A	HC		ZPD Panel
HITACHI	TX51D11VC0CAB	BN07-00122A	HD		20.1" NARROW
HITACHI	TX54D11VC0CAB	BN07-00123A	HE		21.3" NARROW
HITACHI	TX80D12VC0CAB	BN07-00169A	HIZ		"Development new panel for Hitachi 32"" TV (ZPD)"
HITACHI	TX54D11VC0CAB	BN07-00123B	HIZ		Hitachi 21.3"ZPD panel
IBM	ITSX94S	BN07-00017A	IA		-
UNIPAC	UM170E0	BN07-00028A	UA		Loaded by cisdba
HYUNDAI	HT15X13	BN07-00035A	DA		-

Maker	VENDOR P/N	PANEL_CODE	PANEL_ABB	STICKER_CODE	Remarks
HYUNDAI	HT17E11-200	BN07-00049A	DB		TN MODE
HYUNDAI	HT17E11-300	BN07-00093A	DC		HT17E11-300 ZPD panel
HYUNDAI	HT17E11-400	BN07-00094A	DD		HT17E11-400 normal panel
HYUNDAI	HT17E11-400	BN07-00095A	DE		HT17E11-400 ZPD panel code
HYUNDAI	HT17E12	BN07-00096A	DF		HT17E12 (Narrow & slim Design)
HYUNDAI	HT17E12	BN07-00105A	DG		ZPD Panel code
HYUNDAI	HT15X15-D00	BN07-00146A	DH		"Development for Ares 15"" Hydis TV"
HYUNDAI	HT15X15-D01	BN07-00146B	DJ		"Derivation panel HPD for Ares 15"" Hydis TV "
HYUNDAI	HT17E13-100	BN07-00167A	DTH		"PINEHURST-2(BM) PJT 17"" HYDIS PANEL Derivation"
HYUNDAI	HT17E13-100	BN07-00167B	DTZ		"PINEHURST-2(BM) Hydis 17"" ZPD code Derivation"
ACER	L170E3	BN07-00044A	AA		TN(ADT)
ACER	M170EN05	BN07-00076A	AB		AU 17" Panel (Narrow & slim design)
ACER	M170EN05	BN07-00102A	AC		ZPD Panel code
ACER	M190EN02	BN07-00170A	AMH		"AU Monitor 19"" new panel development (P19-1S)"
ACER	M190EN02	BN07-00170B	AMZ		"AU 19"" ZPD code derivation (ZPD)"
ACER	M170EN06	BN07-00171A	ATH		"AU Monitor 17"" New panel development"
ACER	T260XW01	BN07-00163A	AMZ		"AU 26"" new panel developm
(NF26EO)"					
ACER	A201SN01	BN07-00177A	ATZ		"AU TV panel 20.1"" TN SVGA new panel development"
ACER	M170EN06	BN07-00171B	ATZ		"AU Monitor 17"" ZPD code Derivation
ACER	T315XW01	BN07-00194A	AMZ		AU 32" new
ACER	M170EG01	BN07-00192A	ATH		AU TN PSWG type new Panel code
ACER	M170EG01	BN07-00192B	ATZ		AU TN PSWG type NEW panel code derivation
CHIMEI	M170E3-L01	BN07-00050A	CA		TN PANEL
CHIMEI	M150X3-L01	BN07-00051A	CB		COMPATIBLE
CHIMEI	M170E4-L01	BN07-00052A	CC		MVA PANEL
CHIMEI	M150X2-L01	BN07-00066A	CD		CHIMEI 15" PVA PANEL
CHIMEI	M150X3-L01	BN07-00079A	CE		Chimei ZPD panel
CHIMEI	M170E3-L01	BN07-00103A	CF		ZPD Panel code
CHIMEI	M170E4-L01	BN07-00104A	CG		ZPD Panel code
CHIMEI	V296W1-L01	BN07-00120A	CH		MVA
CHIMEI	M170E6-L02	BN07-00126A	CJ		HIGHLAND 17" LOW PANEL
CHIMEI	M190E2-L01	BN07-00131A	CK		GH19AS,BS CHIMEI PANEL
CHIMEI	M150X4-L06	BN07-00137A	CL		15" Narrow & Slim panel
CHIMEI	M170E6-L01	BN07-00133A	CM		"2003-03-11 vendor change"
CHIMEI	M170E6-L01	BN07-00133B	CN		"ZPD derivation panel"
CHIMEI	V201V1-T01	BN07-00135A	CP		"CHIMEI 20.1"" panel development"
CHIMEI	M170E6-L02	BN07-00126B	CQ		"HIGHLAND 17"" LOW PANEL ZPD derivation panel"
CHIMEI	M170E6-L05	BN07-00152A	CR		"CMO 17"" new panel development code"
CHIMEI	M170E6-L05	BN07-00152B	CS		"CMO 17"" ZPD panel code derivation"
CHIMEI	M150X4-L06	BN07-00137B	CT		Chimei 15" Narrow & Slim panel ZPD derivation
CHIMEI	M170E5-L05	BN07-00165A	CTH		CMO 17" new panel development code (GOYA2-PJT)
CHIMEI	M170E5-L05	BN07-00165B	CTZ		CMO 17" ZPD panel(GOYA2-PJT)

Memo



-This Service Manual is a property of Samsung Electronics Co., Ltd.
Any unauthorized use of Manual can be punished under applicable International and/or domestic law.

Samsung Electronics Co.,Ltd.
416, Maetan-3Dong, Yeongtong-Gu, Suwon City,
Gyeonggi-Do, Korea, 443-742
Printed in Korea
P/N : BN82-00138H-00
URL : <http://itself.sec.samsung.co.kr/>