

WWW.ROBOT.HPG.COM.BR

MONITORES DE VIDEO

MANUAL DE SERVIÇO

MODELO

SAMSUNG TFT-LCD GH19A* - 191N

WWW.ROBOT.BPG.COM.BR

Esquemas em Cd-Rom: Monitores, Impressoras,
Televisores, Áudio, Scanners, Etc...

CONFIDENTIAL

SAMSUNG

TFT-LCD MONITOR

Chassis Model
GH19A* 191N

SERVICE Manual

TFT-LCD MONITOR

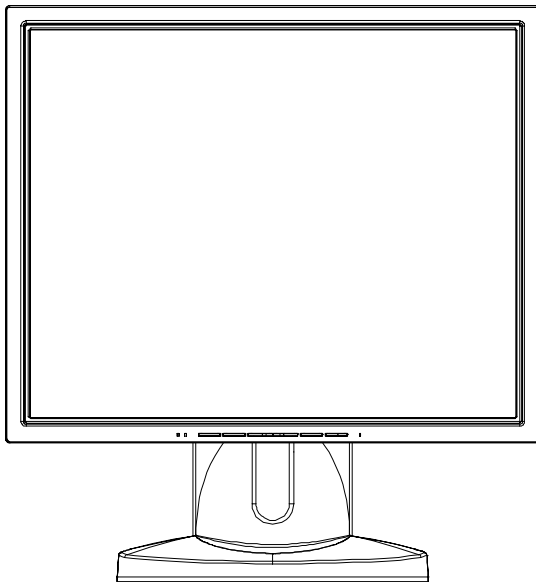

CONTENTS

1. Precautions
2. Product Specifications
3. Disassembly & Reassembly
4. Troubleshooting
5. Exploded View & Parts List
6. Electrical Parts List
7. Block Diagram
8. Wiring Diagram
9. Schematic Diagrams
10. Panel Description



Samsung Electronics Co.,Ltd.

416, Maetan-3Dong, Paldal-Gu, Suwon City, Kyungki-Do, Korea.

Printed in Korea

P/N : BN82-00073E-00

<http://www.samsungmonitor.com> (SyncMaster Worldwide)

<http://www.samsung-monitor.com> (SyncMaster USA)

<http://www.sec.co.kr/monitor> (Korea)

1 Precautions

Follow these safety, servicing and ESD precautions to prevent damage and to protect against potential hazards such as electrical shock.

1-1 Safety Precautions

1-1-1 Warnings

1. For continued safety, do not attempt to modify the circuit board.
2. Disconnect the AC power and DC Power Jack before servicing.
3. When the chassis is operating, semiconductor heatsinks are potential shock hazards.

1-1-2 Servicing the LCD Monitor

1. When servicing the LCD Monitor, remove the static charge by connecting a 10k ohm resistor in series with an insulated wire (such as a test probe) between the chassis and the anode lead. (Disconnect the AC line cord from the AC outlet.)
2. It is essential that service technicians have an accurate voltage meter available at all times. Check the calibration of this meter periodically.

1-1-3 Fire and Shock Hazard

Before returning the monitor to the user, perform the following safety checks:

1. Inspect each lead dress to make certain that the leads are not pinched or that hardware is not lodged between the chassis and other metal parts in the monitor.
2. Inspect all protective devices such as nonmetallic control knobs, insulating materials, cabinet backs, adjustment and compartment covers or shields, isolation resistor-capacitor networks, mechanical insulators, etc.
3. Leakage Current Hot Check (Figure 1-1):
WARNING: Do not use an isolation transformer during this test.
 Use a leakage current tester or a metering system that complies with American National Standards Institute (*ANSI C101.1, Leakage Current for Appliances*), and Underwriters Laboratories (*UL Publication UL1410, 59.7*).

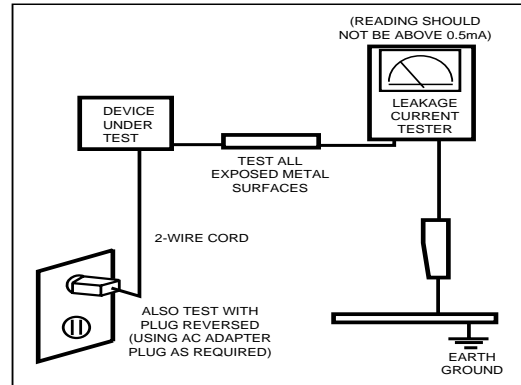



Figure 1-1. Leakage Current Test Circuit

4. With the unit completely reassembled, plug the AC line cord directly into a 120V AC outlet. With the unit's AC switch first in the ON position and then OFF, measure the current between a known earth ground (metal water pipe, conduit, etc.) and all exposed metal parts, including: metal cabinets, screwheads and control shafts. The current measured should not exceed 0.5 milliamp. Reverse the power-plug prongs in the AC outlet and repeat the test.

1-1-4 Product Safety Notices

Some electrical and mechanical parts have special safety-related characteristics which are often not evident from visual inspection. The protection they give may not be obtained by replacing them with components rated for higher voltage, wattage, etc. Parts that have special safety characteristics are identified by  on schematics and parts lists. A substitute replacement that does not have the same safety characteristics as the recommended replacement part might create shock, fire and/or other hazards. Product safety is under review continuously and new instructions are issued whenever appropriate.

1-2 Servicing Precautions

WARNING: An electrolytic capacitor installed with the wrong polarity might explode.

Caution: Before servicing units covered by this service manual, read and follow the Safety Precautions section of this manual.

Note: If unforeseen circumstances create conflict between the following servicing precautions and any of the safety precautions, always follow the safety precautions.

1-2-1 General Servicing Precautions

1. Always unplug the unit's AC power cord from the AC power source and disconnect the DC Power Jack before attempting to:
 - (a) remove or reinstall any component or assembly,
 - (b) disconnect PCB plugs or connectors, (c) connect a test component in parallel with an electrolytic capacitor.
2. Some components are raised above the printed circuit board for safety. An insulation tube or tape is sometimes used. The internal wiring is sometimes clamped to prevent contact with thermally hot components. Reinstall all such elements to their original position.
3. After servicing, always check that the screws, components and wiring have been correctly reinstalled. Make sure that the area around the serviced part has not been damaged.
4. Check the insulation between the blades of the AC plug and accessible conductive parts (examples: metal panels, input terminals and earphone jacks).
5. Insulation Checking Procedure: Disconnect the power cord from the AC source and turn the power switch ON. Connect an insulation resistance meter (500 V) to the blades of the AC plug.
The insulation resistance between each blade of the AC plug and accessible conductive parts (see above) should be greater than 1 megohm.
6. Always connect a test instrument's ground lead to the instrument chassis ground before connecting the positive lead; always remove the instrument's ground lead last.

1-3 Electrostatically Sensitive Devices (ESD) Precautions

Some semiconductor (solid state) devices can be easily damaged by static electricity. Such components are commonly called Electrostatically Sensitive Devices (ESD). Examples of typical ESD are integrated circuits and some field-effect transistors. The following techniques will reduce the incidence of component damage caused by static electricity.

1. Immediately before handling any semiconductor components or assemblies, drain the electrostatic charge from your body by touching a known earth ground. Alternatively, wear a discharging wrist-strap device. To avoid a shock hazard, be sure to remove the wrist strap before applying power to the monitor.
2. After removing an ESD-equipped assembly, place it on a conductive surface such as aluminum foil to prevent accumulation of an electrostatic charge.
3. Do not use freon-propelled chemicals. These can generate electrical charges sufficient to damage ESDs.
4. Use only a grounded-tip soldering iron to solder or desolder ESDs.
5. Use only an anti-static solder removal device. Some solder removal devices not classified as "anti-static" can generate electrical charges sufficient to damage ESDs.
6. Do not remove a replacement ESD from its protective package until you are ready to install it. Most replacement ESDs are packaged with leads that are electrically shorted together by conductive foam, aluminum foil or other conductive materials.
7. Immediately before removing the protective material from the leads of a replacement ESD, touch the protective material to the chassis or circuit assembly into which the device will be installed.
Caution: Be sure no power is applied to the chassis or circuit and observe all other safety precautions.
8. Minimize body motions when handling unpackaged replacement ESDs. Motions such as brushing clothes together, or lifting your foot from a carpeted floor can generate enough static electricity to damage an ESD.

2 Product Specifications

2-1 Specifications

Item	Description
LCD Panel	TFT-LCD panel, RGB vertical stripe, normally black transmissive, 0.298 mm pixel pitch
Scanning Frequency	Horizontal : 30 KHz ~ 81 KHz (Automatic) Vertical : 56 Hz ~ 85 Hz
Display Colors	16,7 Million colors
Maximum Resolution	Horizontal : 1280 Pixels @ 81 KHz Vertical : 1024 Pixels @ 76 Hz
Input Video Signal	Analog : 0.7 Vp-p \pm 5% positive at 75 Ω , internally terminated
Input Sync Signal	Type : Seperate H/V sync. SOG(Optional), Composite, Automatic Synchronization without external switch Level : TTL level (V high \geq 2.0 V, V low \leq 0.8 V)
Maximum Pixel Clock rate	135 MHz
Active Display Horizontal/Vertical	376.32 \pm 3 mm 301.056 \pm 3 mm
AC power voltage & Frequency	AC 90 ~ 264 Volts, 60/50 Hz \pm 3 Hz
Power Consumption	40 W (max)
Dimensions Unit (W x D x H) Carton (W x D x H)	416.3 x 190.3 x 408.5 mm (16.4 x 7.5 x 16.1 inches) 488 x 509 x 260 mm (19.2 x 20.0 x 10.2 inches)
Weight (Net/Gross)	5.6 kg (12.3 lbs) / 6.8 kg (15 lbs)
Environmental Considerations	Operating Temperature : 41°F ~ 95°F (5°C ~ 35°C) Humidity : 10 % ~ 80 % Storage Temperature : -4°F ~ 113°F (-20°C ~ 45°C) Humidity : 5 % ~ 95 %
Audio Characteristics	<ul style="list-style-type: none"> • Audio input : Left/Right Stereo phone jack, 0.5 Vrms • Sound output : 2.2 W /THD 10% at 8 ohm • Frequency response : 40 Hz~20 KHz (at -3 dB) • Headphone : Max 20 mW output (3.5 -pi jack) • Speaker : Internal semi Dome (8 ohm x 2)
<ul style="list-style-type: none"> • GH19A* comply with TCO99 recommendations for reduced electromagnetic fields. • Designs and specifications are subject to change without prior notice. 	

2-2 Pin Assignments

Pin No.	Sync Type	15-Pin D-Sub Signal Cable Connector		
		Separate	Composite	Sync-on-green
1		Red	Red	Red
2		Green	Green	Green + H/V Sync.
3		Blue	Blue	Blue
4		GND	GND	GND
5		GND (DDC Return)	GND (DDC Return)	GND (DDC Return)
6		GND-Red	GND-Red	GND-Red
7		GND-Green	GND-Green	GND-Green
8		GND-Blue	GND-Blue	GND-Blue
9		No Connection	No Connection	Not Used
10		GND-Sync./Self Test	GND-Sync./Self Test	GND-Sync./Self Test
11		GND	GND	GND
12		DDC Data	DDC Data	DDC Data
13		H-Sync.	H/V-Sync.	Not Used
14		V-Sync.	Not Used	Not Used
15		DDC Clock	DDC Clock	DDC Clock

2-3 Timing Chart

This section of the service manual describes the timing that the computer industry recognizes as standard for computer-generated video signals.

2-3-1 LCD Panel Mode : 1 mode

Timing No.	21
Originator	HP
Mode Name	1280/60Hz
Resolution (HxV)	1280x1024
HORIZONTAL	
Frequency	63.981kHz
Total time	11.852 μ s
Active time	9.259 μ s
Blank time	3.778 μ s
Border (L / R)	0.000 μ s
Data time	9.259 μ s
Front porch	0.444 μ s
Sync. width	1.037 μ s
Back porch	2.296 μ s
Sync. polarity	Positive
VERTICAL	
Frequency	60.020Hz
Total time	16.005ms
Active time	15.630ms
Blank time	0.375ms
Border (T / B)	0.000ms
Data time	15.630ms
Front porch	0.016ms
Sync. width	0.047ms
Back porch	0.594ms
Sync. polarity	Positive
Dot Clock	108.00MHz
Sync. Type	Separate
Scan Type	N/I

2-3-2 Supported Modes (1)

Timing No.	1	2	3	11	17
Originator	IBM	IBM	IBM	VESA	VESA
Mode Name	VGA1	VGA2	VGA3	640/72Hz	640/75Hz
Resolution (HxV)	640x350	720x400	640x480	640x480	640x480
HORIZONTAL					
Frequency	31.469kHz	31.469kHz	31.469kHz	37.861kHz	37.500kHz
Total time	31.778μs	31.777μs	31.778μs	26.413 μs	26.667μs
Active time	26.058μs	26.058μs	26.058μs	20.825 μs	20.317μs
Blank time	5.720μs	5.720μs	5.720 μs	5.588 μs	6.350μs
Border (L / R)	0.318μs	0.318μs	0.318 μs	0.254 μs	0.000μs
Data time	25.422μs	25.422μs	25.422μs	20.317 μs	20.317μs
Front porch	0.318μs	0.318μs	0.318 μs	0.508 μs	0.508μs
Sync. width	3.813μs	3.813μs	3.813 μs	1.270 μs	2.032μs
Back porch	1.589μs	1.589μs	1.589 μs	3.810 μs	3.810μs
Sync. polarity	Positive	Negative	Negative	Negative	Negative
VERTICAL					
Frequency	70.086Hz	70.087Hz	59.940Hz	72.809Hz	75.000Hz
Total time	14.268ms	14.268ms	16.683ms	13.735ms	13.333ms
Active time	11.504ms	13.155ms	15.761ms	13.100ms	12.800ms
Blank time	2.764ms	1.113ms	0.922ms	0.635ms	0.533ms
Border (T / B)	0.191ms	0.222ms	0.254ms	0.211ms	0.000ms
Data time	11.122ms	12.711ms	15.253ms	12.678ms	12.800ms
Front porch	0.985ms	0.191ms	0.064ms	0.026ms	0.027ms
Sync. width	0.064ms	0.064ms	0.064ms	0.079ms	0.080ms
Back porch	1.716ms	0.858ms	0.794ms	0.528ms	0.427ms
Sync. polarity	Negative	Positive	Negative	Negative	Negative
Dot Clock	25.175MHz	28.322MHz	25.175MHz	31.500MHz	31.500MHz
Sync. Type	Separate	Separate	Separate	Separate	Separate
Scan Type	N/I	N/I	N/I	N/I	N/I

2-3-2 Supported Modes (2)

Timing No.	42	32	33	12	13
Originator	VESA	MAC	MAC	VESA	VESA
Mode Name	640/85Hz	640/67Hz	832/75Hz	800/56Hz	800/60Hz
Resolution (HxV)	640x480	640x480	832x624	800x600	800x600
HORIZONTAL					
Frequency	43.269kHz	35.000kHz	49.726kHz	35.156kHz	37.879kHz
Total time	23.111 μ s	28.571 μ s	20.110 μ s	28.444 μ s	26.400 μ s
Active time	17.778 μ s	21.164 μ s	14.524 μ s	22.222 μ s	20.000 μ s
Blank time	5.333 μ s	7.407 μ s	5.586 μ s	6.222 μ s	6.400 μ s
Border (L / R)	0.000 μ s	0.000 μ s	0.000 μ s	0.000 μ s	0.000 μ s
Data time	17.778 μ s	21.164 μ s	14.524 μ s	22.222 μ s	20.000 μ s
Front porch	1.556 μ s	2.116 μ s	0.559 μ s	0.667 μ s	1.000 μ s
Sync. width	1.556 μ s	2.116 μ s	1.117 μ s	2.000 μ s	3.200 μ s
Back porch	2.222 μ s	3.175 μ s	3.910 μ s	3.556 μ s	2.200 μ s
Sync. polarity	Negative	Negative	Negative	Positive or Negative	Positive
VERTICAL					
Frequency	85.008Hz	66.667Hz	74.551Hz	56.250Hz	60.317Hz
Total time	11.764ms	15.000ms	13.414ms	17.778ms	16.579ms
Active time	11.093ms	13.714ms	12.549ms	17.067ms	15.840ms
Blank time	0.671ms	1.286ms	0.865ms	0.711ms	0.739ms
Border (T / B)	0.000ms	0.000ms	0.000ms	0.000ms	0.000ms
Data time	11.093ms	13.714ms	12.549ms	17.067ms	15.840ms
Front porch	0.023ms	0.086ms	0.020ms	0.028ms	0.026ms
Sync. width	0.069ms	0.086ms	0.060ms	0.057ms	0.106ms
Back porch	0.578ms	1.114ms	0.784ms	0.626ms	0.607ms
Sync. polarity	Negative	Negative	Negative	Positive or Negative	Positive
Dot Clock	36.000MHz	30.240MHz	57.284MHz	36.000MHz	40.000MHz
Sync. Type	Separate	Separate Composite Sync.-on-G	Separate Composite Sync.-on-G	Separate	Separate
Scan Type	N/I	N/I	N/I	N/I	N/I

2-3-2 Supported Modes (3)

Timing No.	14	18	3	15	16
Originator	VESA	VESA	VESA	VESA	VESA
Mode Name	800/72Hz	800/75Hz	800/85Hz	1024/60Hz	1024/70Hz
Resolution (HxV)	800x600	800x600	800x600	1024x768	1024x768
HORIZONTAL					
Frequency	48.077kHz	46.875kHz	53.674kHz	48.363kHz	56.476kHz
Total time	20.800µs	21.333µs	18.631µs	20.677µs	17.707µs
Active time	16.000µs	16.162µs	14.222µs	15.754µs	13.653µs
Blank time	4.800µs	5.171µs	4.409µs	4.923µs	4.054µs
Border (L / R)	0.000µs	0.000µs	0.000µs	0.000µs	0.000µs
Data time	16.000µs	16.162µs	14.222µs	15.754µs	13.653µs
Front porch	1.120µs	0.323µs	0.569µs	0.369µs	0.320µs
Sync. width	2.400µs	1.616µs	1.138µs	2.092µs	1.813µs
Back porch	1.280µs	3.232µs	2.702µs	2.462µs	1.920µs
Sync. polarity	Positive	Positive	Positive	Negative	Negative
VERTICAL					
Frequency	72.188Hz	75.000Hz	85.061Hz	60.004Hz	70.069Hz
Total time	13.853ms	13.333ms	11.756ms	16.666ms	14.272ms
Active time	12.480ms	12.800ms	11.179ms	15.880ms	13.599ms
Blank time	1.373ms	0.533ms	0.577ms	0.786ms	0.673ms
Border (T / B)	0.000ms	0.000ms	0.000ms	0.000ms	0.000ms
Data time	12.480ms	12.800ms	11.179ms	15.880ms	13.599ms
Front porch	0.770ms	0.021ms	0.019ms	0.062ms	0.053ms
Sync. width	0.125ms	0.064ms	0.056ms	0.124ms	0.106ms
Back porch	0.478ms	0.448ms	0.503ms	0.600ms	0.513ms
Sync. polarity	Positive	Positive	Positive	Negative	Negative
Dot Clock	50.000MHz	49.500MHz	56.250MHz	65.000MHz	75.000MHz
Sync. Type	Separate	Separate	Separate	Separate	Separate
Scan Type	N/I	N/I	N/I	N/I	N/I

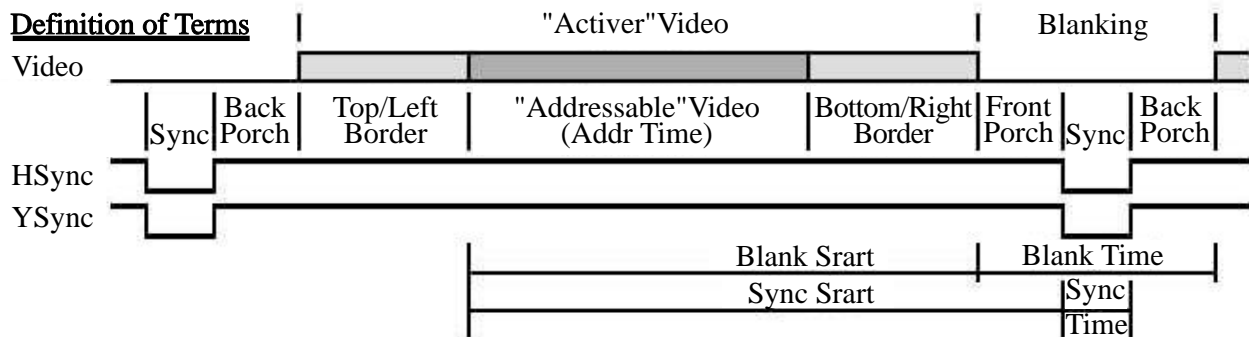

2-3-2 Supported Modes (4)

Timing No.	19	44	20	
Originator	VESA	VESA	VESA	SUN
Mode Name	1024/75Hz	1024/85Hz	1280/75Hz	1280/76Hz
Resolution (HxV)	1024x768	1024x768	1280x1024	1280x1024
HORIZONTAL				
Frequency	60.023kHz	68.677kHz	79.976kHz	81.129kHz
Total time	16.660μs	14.561μs	12.504μs	1664 pixels
Active time	13.003μs	10.836μs	9.481 μs	1280 pixels
Blank time	3.657μs	3.725μs	3.023μs	
Border (L / R)	0.000μs	0.000μs	0.000μs	
Data time	13.003μs	10.836μs	9.481 μs	
Front porch	0.203μs	0.508μs	0.119μs	32 pixels
Sync. width	1.219μs	1.016μs	1.067μs	64 pixels
Back porch	2.235μs	2.201μs	1.837μs	288 pixels
Sync. polarity	Positive	Positive	Positive	Negative
VERTICAL				
Frequency	75.029Hz	84.997Hz	75.025Hz	76.106Hz
Total time	13.328ms	11.765ms	13.329ms	1066 pixels
Active time	12.795ms	11.183ms	12.804ms	1024 pixels
Blank time	0.533ms	0.582ms	0.525ms	
Border (T / B)	0.000ms	0.000ms	0.000ms	
Data time	12.795ms	11.183ms	12.804ms	
Front porch	0.017ms	0.015ms	0.013ms	2 pixels
Sync. width	0.050ms	0.044ms	0.038ms	8 pixels
Back porch	0.466ms	0.524ms	0.475ms	32 pixels
Sync. polarity	Positive	Positive	Positive	Negative
Dot Clock	78.750MHz	94.500MHz	135.00MHz	135.00MHz
Sync. Type	Separate	Separate	Separate	Composite
Scan Type	N/I	N/I	N/I	N/I

Memo

3 Disassembly and Reassembly

This section of the service manual describes the disassembly and reassembly procedures for the GH19A* monitors.

WARNING: This monitor contains electrostatically sensitive devices. Use caution when handling these components.

3-1 Disassembly

- Cautions:**
1. Disconnect the monitor from the power source before disassembly.
 2. Follow these directions carefully; never use metal instruments to pry apart the cabinet.

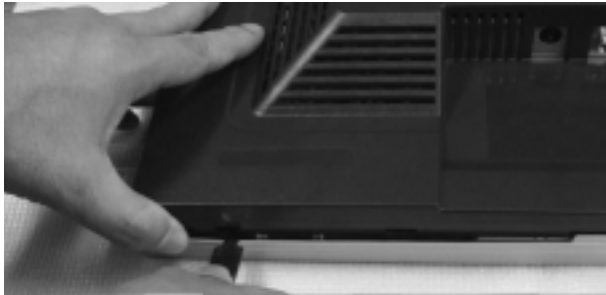

1. Put the jig into the left opening hole and lift up the panel until the snap of the cover rear opens.

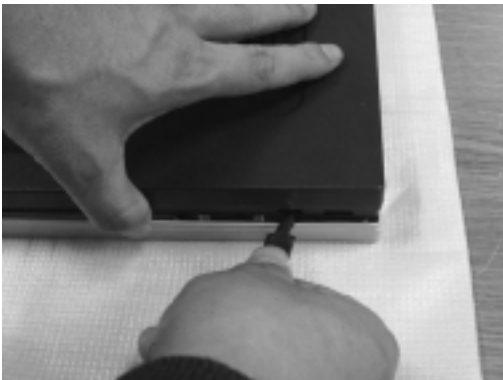

2. Put the jig into the right opening hole and lift up the panel until the snap of the cover rear opens.



3. Put the jig into the gap (between the right side of the panel and Front cover) and tilt up front cover until the snap opens.

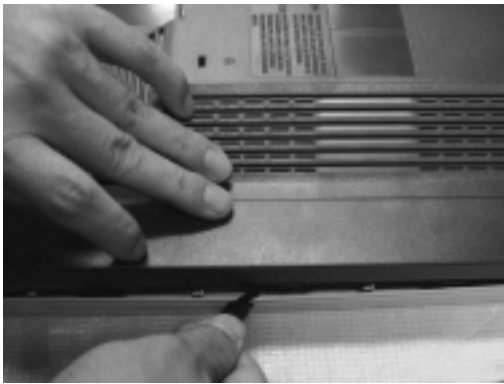

4. Put the jig into the gap (between the right side of the panel and front cover) and tilt up front cover until the snap opens.



5. Put the jig into the gap (between the right side of the panel and Front cover) and tilt up front cover until the snap opens.



6. After pushing the right bottom of the panel with jig.

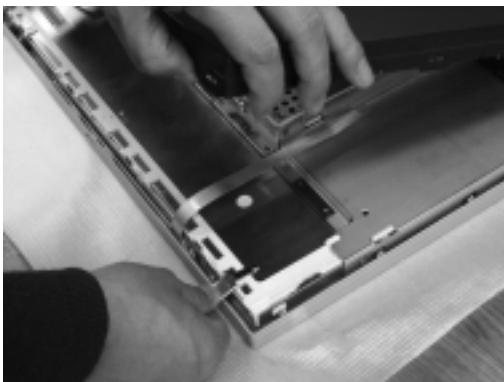

7. Pull up the rear cover until it opens fully.

3-2 Reassembly

Reassembly procedures are in the reverse order of disassembly procedures.

4-1 Troubleshooting

- Notes:**
- Before troubleshooting, setup the PC's display as below.
 - Resolution: 1280 x 1024
 - H-frequency: 63 KHz
 - V-frequency: 75 Hz
 - If no picture appears, make sure the power cord is correctly connected.
 - Check the following circuits.
 - No raster appears: Stand PCB, Main PCB
 - 12V develop but no screen: Main PCB
 - 12V does not develop: Main PCB
 - If you push and hold the Exit(-) button for more than 5 seconds, the monitor automatically turns back to the factory preset.

4-1-1 No Power

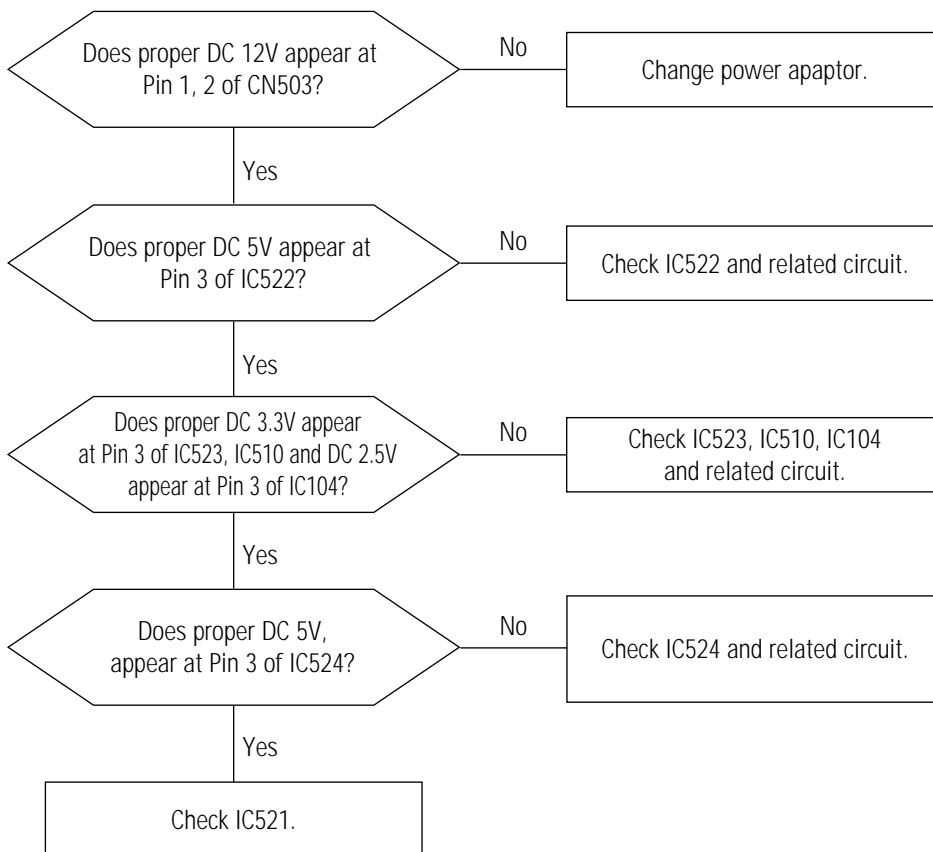

4-1-2 No Video

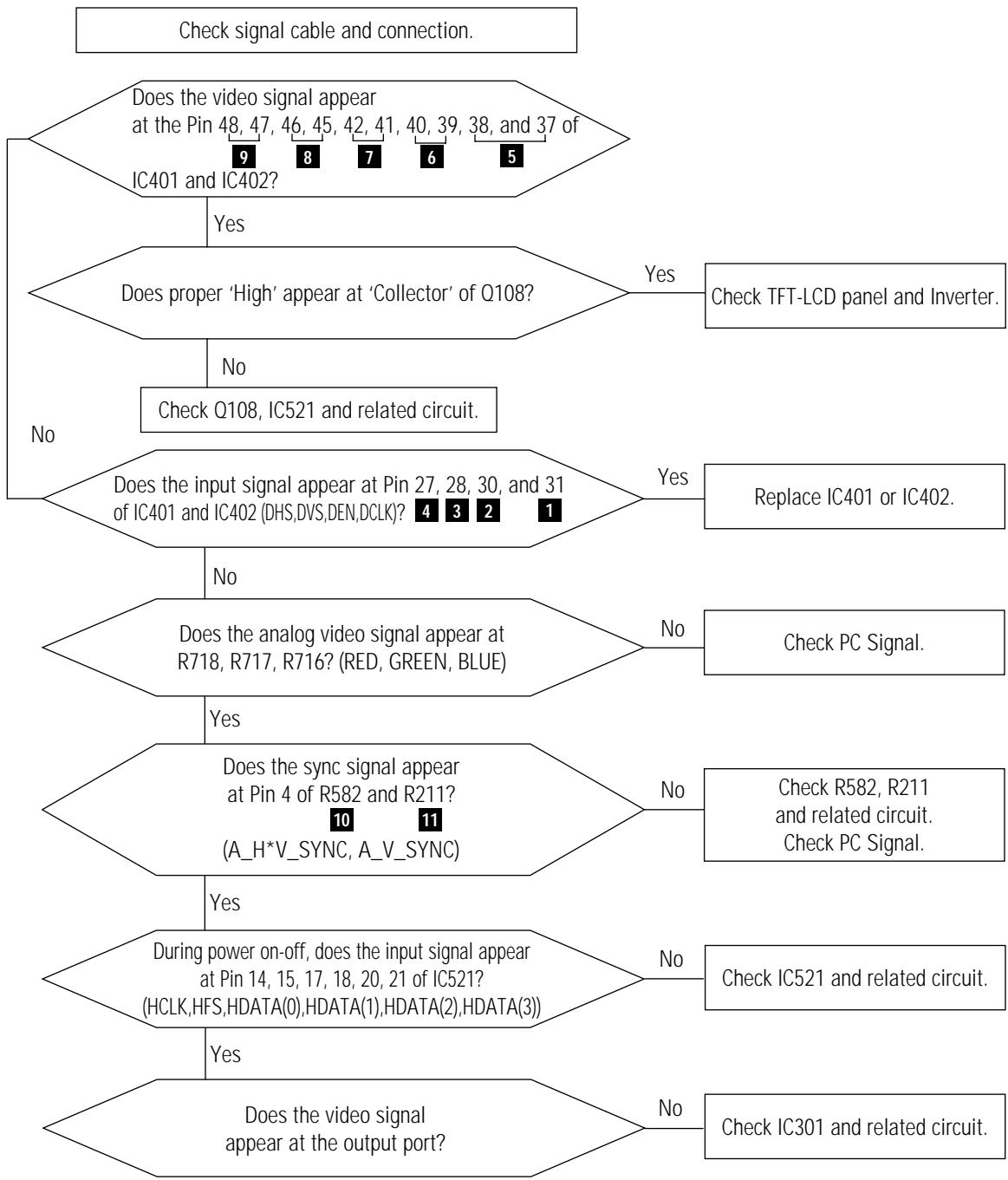

WAVEFORMS

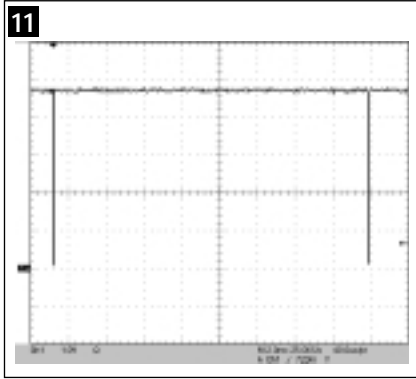
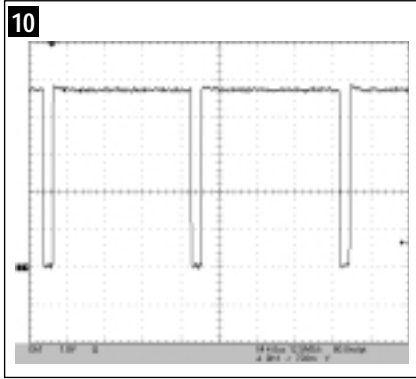
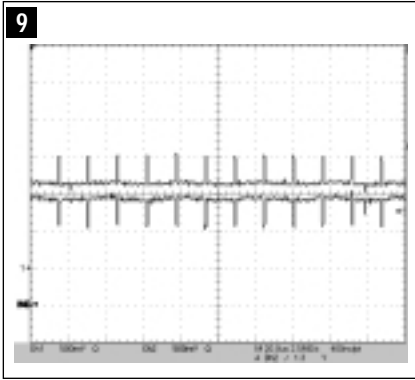
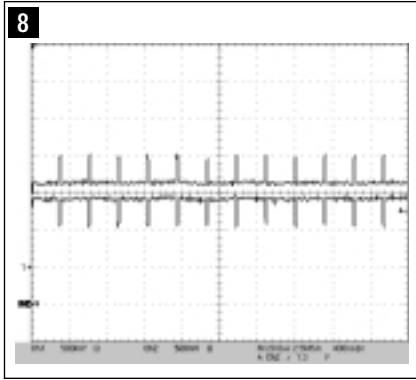
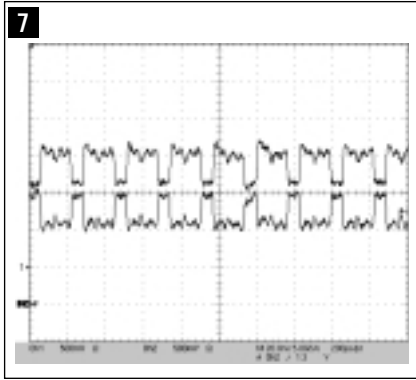
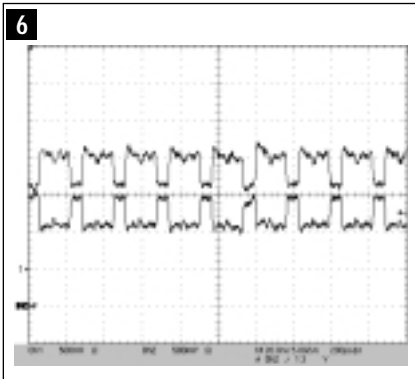
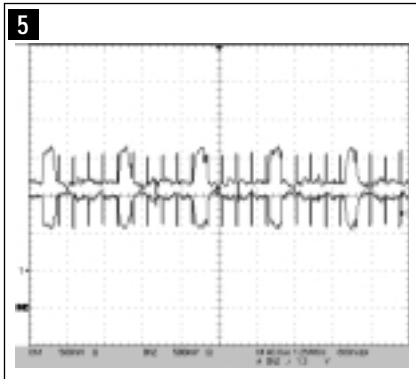
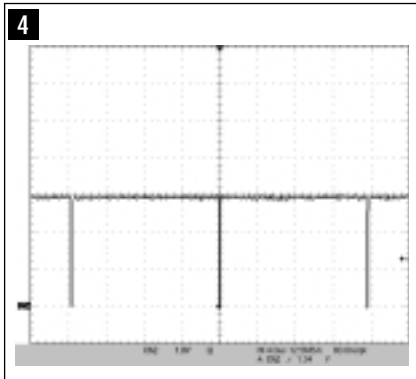
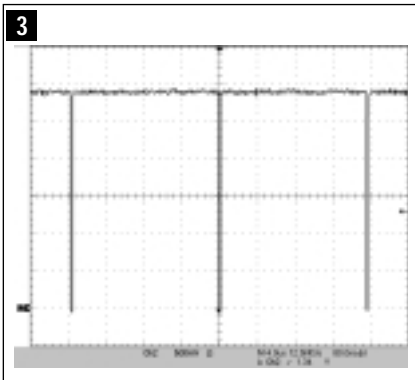
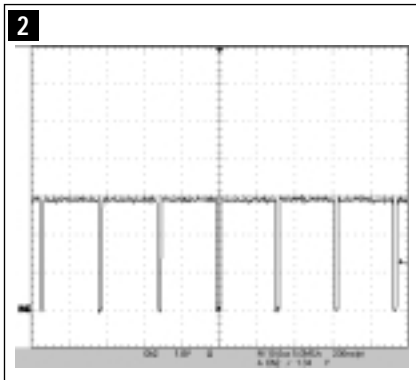
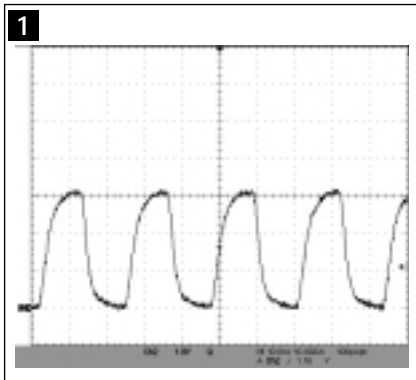

4-1-3 No Sound

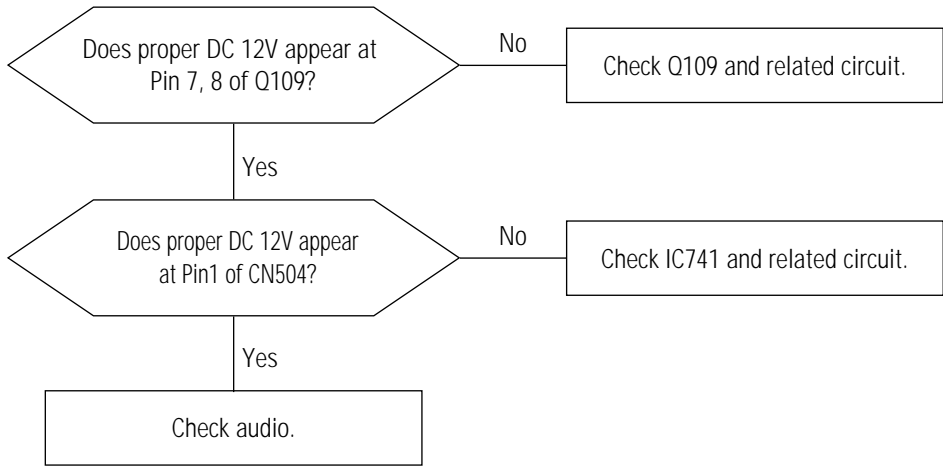

5 Exploded View and Parts List

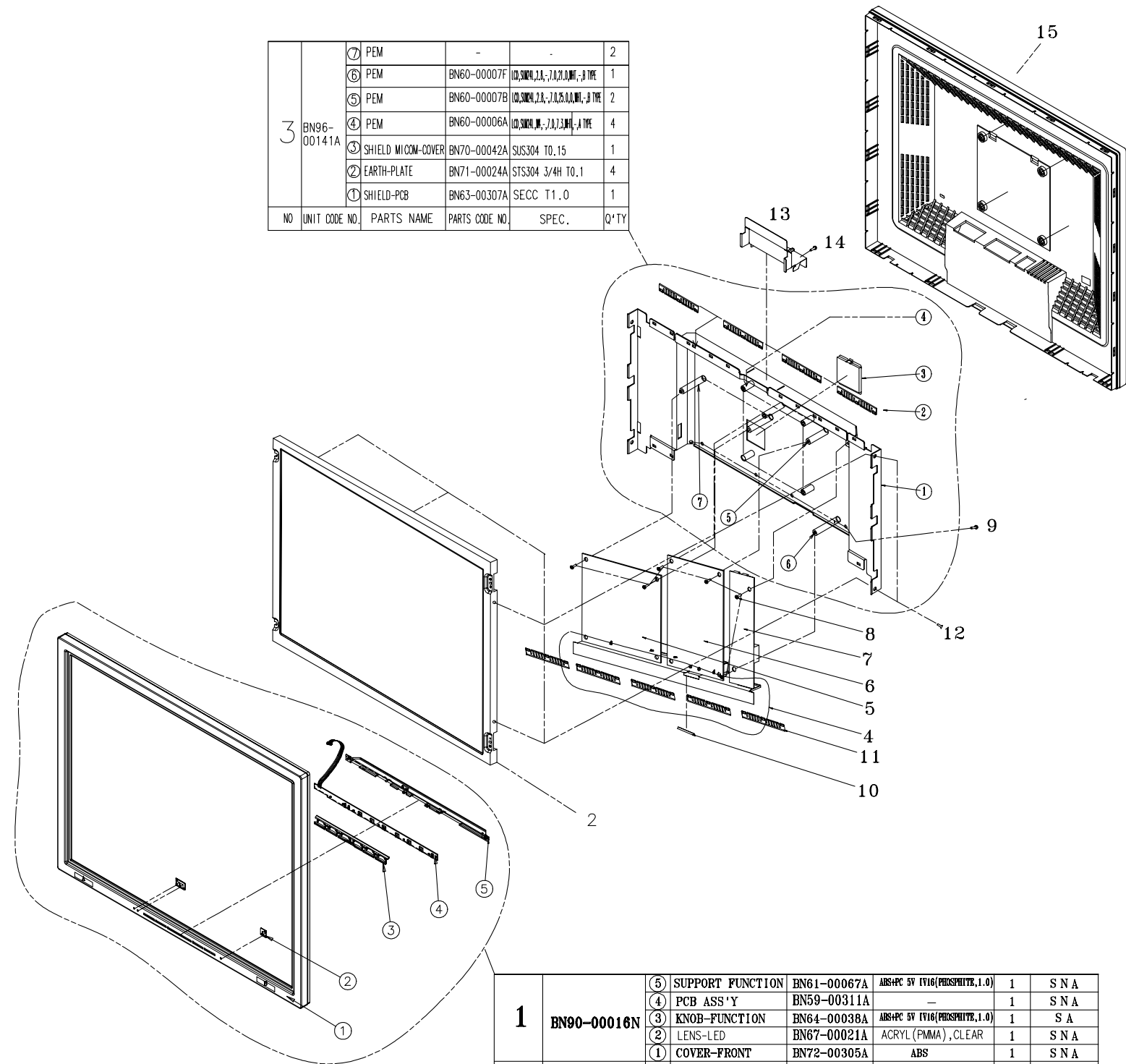

3	BN96-00141A	⑦	PEM	-	-	2
		⑥	PEM	BN60-00007F	(D,S)M4,2x,7,0,21,0,WF,-B TYPE	1
		⑤	PEM	BN60-00007B	(D,S)M4,2x,7,0,25,0,WF,-B TYPE	2
		④	PEM	BN60-00006A	(D,S)M4,2x,7,0,7,5,WF,-A TYPE	4
		③	SHIELD M/COM-COVER	BN70-00042A	SUS304 TO.15	1
		②	EARTH-PLATE	BN71-00024A	STS304 3/4H TO.1	4
		①	SHIELD-PCB	BN63-00307A	SECC T1.0	1
NO	UNIT CODE NO.	PARTS NAME	PARTS CODE NO.	SPEC.	Q'TY	

1	BN90-00016N	⑤	SUPPORT FUNCTION	BN61-00067A	ABS+PC 5V IV16(PIROSPHITE,1.0)	1	S N A
		④	PCB ASS'Y	BN59-00311A	-	1	S N A
		③	KNOB-FUNCTION	BN64-00038A	ABS+PC 5V IV16(PIROSPHITE,1.0)	1	S A
		②	LENS-LED	BN67-00021A	ACRYL (PMMA), CLEAR	1	S N A
		①	COVER-FRONT	BN72-00305A	ABS	1	S N A
NO	UNIT CODE NO.	NO	ITEM	CODE NO.	SPEC.	Q'TY	REMARK

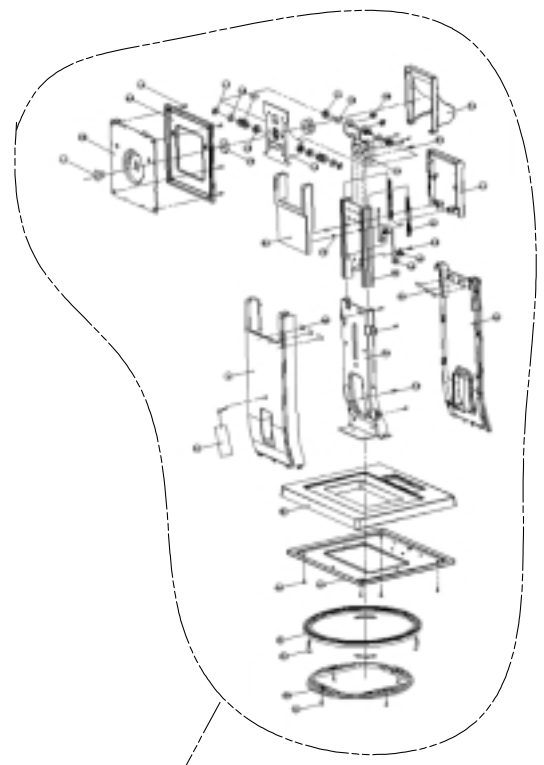

10-7	6003-00118B	-	SH.+B.M.L10.ZPC(YEL).SWRCHBA	4	
10-6	BN72-00280A	SHIELD GUIDE	ABS HB BK07	1	
10-5	BRACKET STAND	SP		4	
10-4	BN72-00279A	SHIELD BASE	ACETAL	1	
10-3	BN61-00167A	BRKT BOTTOM	SECC T1.0	1	
10-2	-	SCREW-TAPTITE	SH.+B.M.L6.ZPC(YEL).SWRCHBA	4	
10-1	BN63-00312A	COVER BASE STAND	ABS HB	1	
9-1	BN70-00222A	UNIT STOPPER-PIN	ABS	1	
8-2	-	FELT STAND	FELT T1.0, W10.0, L4.0	2	
8-1	BN63-00311A	COVER REAR STAND	ABS HB	1	
7-2	6003-00027A	SCREW-TAPTITE	SH.+B.M.L10.ZPC(YEL).SWRCHBA	4	
7-1	BN61-00165A	BRKT BODY (PIVOT)	SECC T2.0	1	
6-2	BN63-00313A	FELT STAND	FELT T1.0, W10.0, L4.0	3	
6-1	BN63-00310A	COVER FRONT STAND	ABS HB	1	
5-6	6003-00030	SCREW-TAPTITE	SH.+S.M.L6.ZPC(YEL).SWRCHBA	2	
5-5	6003-00027B	SCREW-TAPTITE	SH.+B.M.L10.ZPC(YEL).SWRCHBA	2	
5-4	BN61-00162A	GUIDE LEFT	ACETAL	2	
5-3	BN72-00283A	GUIDE SPRING	ACETAL	2	
5-2	-	PLAT SPRING COIL	SUS304-EN	2	
5-1	BN61-00164A	BRKT LEFT	ABS+PC T2.0	1	
4-1	BN63-00313A	COVER HINGE FRONT	ABS HB	1	
3-1	BN63-00313A	COVER HINGE FRONT	ABS HB	1	
2-1	BN72-00214A	COVER PIVOT	ABS HB	1	
1-15	6003-00030	SCREW-TAPTITE	SH.+S.M.L6.ZPC(YEL).SWRCHBA	4	
1-14	BN63-00163A	BRKT HINGE	SECC T2.0	1	
1-13	-	SPRING		2	
1-12	-	SHAFT HINGE	SUMZRL	2	
1-11	-	WASHER	3K-C T1.0	4	
1-10	BN70-00228A	BRKT PIVOT	SECC T2.0	1	
1-9	1501-0003-0003	NOI		2	
1-8	1501-0003-0002	GUIDE WASHER	3K-C	2	
1-7	1501-0003-0004	DISK SPRING	3K-C	4	
1-6	1501-0003-0002	SPACE WASHER	3K-C	4	
1-5	-	WASHER		5	
1-4	6003-001547	SCREW-TAPTITE	SH.+B.M.L10.ZPC(BLW).SWRCHBA	4	
1-3	BN70-00138A	COVER VESA PLATE-P	ABS HB	1	
1-2	BN70-00222A	BRACKET VESA-P	SECC-2B T2.0	1	
1-1	-	SHAFT PIVOT	SUMZRL	1	
UNIT CODE	NO.	CODE-NO	DESCRIPTION	SPECIFICATION	Q'TY

16	UNIT STAND(SIMPLE)	BN90-00333A	ASSY	1	SA
15	COVER-REAR	BN63-00306C	ABS HB BK07	1	SNA
14	SCREW-TAPTITE	6003-000117	SH.+B.M.L6.ZPC(YEL)	1	SA
13	SHIELD-LVDS	BN63-00309A	SPTC 0.3T	1	SNA
12	SCREW-MACHINE	6001-000364	SH.+B.M.L6.ZPC(YEL).SWRCHBA	4	SA
11	EARTH-PLATE	BN71-00024A	STS304 3/4H TO.1	2	SNA
10	GUIDE-POWER	BN61-00161A	ABS PC	1	SNA
9	SCREW-TAPTITE	6003-000117	SH.+B.M.L6.ZPC(YEL)	7	SA
8	SCREW-TAPTITE	6003-000264	SH.+B.M.L6.ZPC(YEL)	6	SA
7	ASSY-INVERTOR	BN44-00041A	ASSY		SA
6	ADAPTOR	BN44-00055B	ASSY		SA
5	ASSY-MAIN-PCB	BN94-00325A	ASSY		SA
4	UNIT-SHIELD-D/SUB	BN96-00142A	ASSY	1	SNA
3	UNIT-SHIELD-PCB	BN96-00141A	ASSY	1	SNA
2	LCD PANEL	BN07-00057A	EH(TN)	1	SA
1	UNIT-COVER-FRONT	BN90-00016N	ASSY	1	SA
NO	PART NAME	CODE NO.	SPEC.	Q'TY	REMARK

Memo

6 Electrical Parts List

6-1 Main PCB Parts

Loc. No.	Code No.	Description	Specification	Remarks
-	BN94-00325A	ASSY PCB MAIN	GH19AS, GH19AS-SXM8/0001	SNA
C373	2409-001043	C-ORGANIC	47UF, 20%, 6.3V, WT, TP, 6.3X6.8, 2.5	
C622	2409-001043	C-ORGANIC	47UF, 20%, 6.3V, WT, TP, 6.3X6.8, 2.5	
CIS06	6011-001445	BOLT-SOCKET	4-40 UNC, L7, NI PLT, BRASS, HEX SOCKET	SNA
CIS07	BN39-00162A	CBF HARNESS	GH17LS, UL/CSA, UL1061#28, 12P/12P, 240MM, WHT, UL1061#28, 51021-1200, 51021-1200, BK, 300	
CIS08	BN39-00207B	LEAD CONNECTOR-ASSY	GH17BS, UL1617#22, UL/CSA, 3(2)P, #22, JRA-1102(HS/W), YH396-03V, BK, 85MM, 1617#22, SJ02-	
CIS09	BN39-00241B	LEAD CONNECTOR	GH17BS, UL1571#30, UL/CSA, 30P, #30, 12507HS-30, FI-X30H, BK, 210MM, 1571#30, SJ02-01-116,	
CIS10	BN44-00041A	INVERTER	ML17, SIC1803, 48KHz, 14VDC, 1.5mArms, 7.2mArms, 48KHz, 160*45*17, ALAMP, 48KHz, -	
CIS11	BN44-00055B	ADAPTOR	DP46L, GH18 DELL, 90-264, 12.5V/5.0V, 2.5A/2A, 42W, 0 TO +40 C, INLET SOKET NORMAL	
CIS12	BN61-00161A	GUIDE-POWER	GH17PS, ABS PC, -	SNA
CIS13	BN63-00303A	SHIELD-POWER	GH17PS, SECC, T0.5	SNA
CIS14	BN63-00308B	SHIELD-D_SUB	GH19AS, SPT, T0.5	
CIS15	BN70-00269A	PLATE	GH19PS, PBC, -, T0.15, -, -, -, -, -	SNA
CIS16	BN71-00024A	EARTH-PLATE	GH17LS, SUS, T0.15	SNA
CN201	3701-001219	CONNECTOR-DSUB	15P, 3R, FEMALE, ANGLE, AUF	
CN503	3711-004853	CONNECTOR-HEADER	BOX, 7P, 1R, 2MM, ANGLE, SN, WHT	SNA
CN504	3722-000117	JACK-DC POWER	3P, 3.5MM, AG, BLK, NO	SNA
IN/PCB+SH/COV	6003-000264	SCREW-TAPTITE	PWH, +, B, M3, L6, ZPC(YEL), SWRCH18	SNA
SH/PCB+M/PCB	6003-000264	SCREW-TAPTITE	PWH, +, B, M3, L6, ZPC(YEL), SWRCH18	SNA
SH/PCB+SH/D_SUB	6003-000117	SCREW-TAPTITE	BH, +, B, M3, L6, ZPC(YEL), SWRCH18A	SNA
SH/PCB+SH/POW	6003-000117	SCREW-TAPTITE	BH, +, B, M3, L6, ZPC(YEL), SWRCH18A	SNA
SH/PCB+SMPS	6003-000264	SCREW-TAPTITE	PWH, +, B, M3, L6, ZPC(YEL), SWRCH18	SNA
CIS17	BN96-00141A	ASSY MISC P-SHIELD	GH19BS, SECC T1.0	
CIS18	BN96-00142A	ASSY MISC P-SHIELD D/SUB	GH19BS, SPT, T0.2	
-	BN97-00116A	ASSY SMD	GH19AS, GH19AS-SXM8/0001	SNA
C110	2203-005005	C-CERAMIC, CHIP	100nF, 10%, 16V, X7R, TP, 1608	
C112	2402-001042	C-AL, SMD	100uF, 20%, 16V, GP, TP, 6.6x6.6x5.4mm	
C135	2203-005005	C-CERAMIC, CHIP	100nF, 10%, 16V, X7R, TP, 1608	
C204	2203-000626	C-CERAMIC, CHIP	0.022nF, 5%, 50V, NPO, TP, 1608	
C214	2203-000236	C-CERAMIC, CHIP	0.1nF, 5%, 50V, NPO, TP, 1608	
C215	2203-000236	C-CERAMIC, CHIP	0.1nF, 5%, 50V, NPO, TP, 1608	
C301	2203-005005	C-CERAMIC, CHIP	100nF, 10%, 16V, X7R, TP, 1608	
C302	2203-005005	C-CERAMIC, CHIP	100nF, 10%, 16V, X7R, TP, 1608	
C303	2203-005005	C-CERAMIC, CHIP	100nF, 10%, 16V, X7R, TP, 1608	
C304	2203-005005	C-CERAMIC, CHIP	100nF, 10%, 16V, X7R, TP, 1608	
C305	2203-005005	C-CERAMIC, CHIP	100nF, 10%, 16V, X7R, TP, 1608	
C306	2203-005005	C-CERAMIC, CHIP	100nF, 10%, 16V, X7R, TP, 1608	
C307	2203-005005	C-CERAMIC, CHIP	100nF, 10%, 16V, X7R, TP, 1608	
C308	2203-005005	C-CERAMIC, CHIP	100nF, 10%, 16V, X7R, TP, 1608	
C309	2203-005005	C-CERAMIC, CHIP	100nF, 10%, 16V, X7R, TP, 1608	
C310	2203-005005	C-CERAMIC, CHIP	100nF, 10%, 16V, X7R, TP, 1608	
C311	2203-001607	C-CERAMIC, CHIP	0.22nF, 5%, 50V, NPO, TP, 1608	
C312	2203-001607	C-CERAMIC, CHIP	0.22nF, 5%, 50V, NPO, TP, 1608	
C313	2203-001607	C-CERAMIC, CHIP	0.22nF, 5%, 50V, NPO, TP, 1608	
C314	2203-001607	C-CERAMIC, CHIP	0.22nF, 5%, 50V, NPO, TP, 1608	
C315	2203-001607	C-CERAMIC, CHIP	0.22nF, 5%, 50V, NPO, TP, 1608	
C316	2203-001607	C-CERAMIC, CHIP	0.22nF, 5%, 50V, NPO, TP, 1608	

Loc. No.	Code No.	Description	Specification	Remarks
C317	2203-001607	C-CERAMIC,CHIP	0.22nF,5%,50V,NPO,TP,1608	
C318	2203-001607	C-CERAMIC,CHIP	0.22nF,5%,50V,NPO,TP,1608	
C319	2203-001607	C-CERAMIC,CHIP	0.22nF,5%,50V,NPO,TP,1608	
C321	2402-000135	C-AL,SMD	22uF,20%,16V,GP,TP,5.3x5.3x5.4	
C322	2203-005005	C-CERAMIC,CHIP	100nF,10%,16V,X7R,TP,1608	
C323	2203-005005	C-CERAMIC,CHIP	100nF,10%,16V,X7R,TP,1608	
C324	2203-005005	C-CERAMIC,CHIP	100nF,10%,16V,X7R,TP,1608	
C325	2203-005005	C-CERAMIC,CHIP	100nF,10%,16V,X7R,TP,1608	
C326	2203-001607	C-CERAMIC,CHIP	0.22nF,5%,50V,NPO,TP,1608	
C327	2203-001607	C-CERAMIC,CHIP	0.22nF,5%,50V,NPO,TP,1608	
C328	2203-001607	C-CERAMIC,CHIP	0.22nF,5%,50V,NPO,TP,1608	
C329	2203-001607	C-CERAMIC,CHIP	0.22nF,5%,50V,NPO,TP,1608	
C333	2203-005005	C-CERAMIC,CHIP	100nF,10%,16V,X7R,TP,1608	
C334	2203-005005	C-CERAMIC,CHIP	100nF,10%,16V,X7R,TP,1608	
C335	2203-005005	C-CERAMIC,CHIP	100nF,10%,16V,X7R,TP,1608	
C336	2203-005005	C-CERAMIC,CHIP	100nF,10%,16V,X7R,TP,1608	
C337	2203-005005	C-CERAMIC,CHIP	100nF,10%,16V,X7R,TP,1608	
C338	2203-005005	C-CERAMIC,CHIP	100nF,10%,16V,X7R,TP,1608	
C339	2203-005005	C-CERAMIC,CHIP	100nF,10%,16V,X7R,TP,1608	
C340	2203-005005	C-CERAMIC,CHIP	100nF,10%,16V,X7R,TP,1608	
C341	2203-001607	C-CERAMIC,CHIP	0.22nF,5%,50V,NPO,TP,1608	
C342	2203-001607	C-CERAMIC,CHIP	0.22nF,5%,50V,NPO,TP,1608	
C343	2203-001607	C-CERAMIC,CHIP	0.22nF,5%,50V,NPO,TP,1608	
C344	2203-001607	C-CERAMIC,CHIP	0.22nF,5%,50V,NPO,TP,1608	
C345	2203-001607	C-CERAMIC,CHIP	0.22nF,5%,50V,NPO,TP,1608	
C346	2203-001607	C-CERAMIC,CHIP	0.22nF,5%,50V,NPO,TP,1608	
C347	2203-001607	C-CERAMIC,CHIP	0.22nF,5%,50V,NPO,TP,1608	
C348	2203-001607	C-CERAMIC,CHIP	0.22nF,5%,50V,NPO,TP,1608	
C351	2402-000135	C-AL,SMD	22uF,20%,16V,GP,TP,5.3x5.3x5.4	
C352	2203-005005	C-CERAMIC,CHIP	100nF,10%,16V,X7R,TP,1608	
C353	2203-005005	C-CERAMIC,CHIP	100nF,10%,16V,X7R,TP,1608	
C354	2203-005005	C-CERAMIC,CHIP	100nF,10%,16V,X7R,TP,1608	
C355	2203-005005	C-CERAMIC,CHIP	100nF,10%,16V,X7R,TP,1608	
C356	2203-005005	C-CERAMIC,CHIP	100nF,10%,16V,X7R,TP,1608	
C357	2203-001607	C-CERAMIC,CHIP	0.22nF,5%,50V,NPO,TP,1608	
C358	2203-001607	C-CERAMIC,CHIP	0.22nF,5%,50V,NPO,TP,1608	
C359	2203-001607	C-CERAMIC,CHIP	0.22nF,5%,50V,NPO,TP,1608	
C360	2203-001607	C-CERAMIC,CHIP	0.22nF,5%,50V,NPO,TP,1608	
C361	2203-001607	C-CERAMIC,CHIP	0.22nF,5%,50V,NPO,TP,1608	
C363	2402-000135	C-AL,SMD	22uF,20%,16V,GP,TP,5.3x5.3x5.4	
C364	2203-005005	C-CERAMIC,CHIP	100nF,10%,16V,X7R,TP,1608	
C365	2203-005005	C-CERAMIC,CHIP	100nF,10%,16V,X7R,TP,1608	
C366	2203-005005	C-CERAMIC,CHIP	100nF,10%,16V,X7R,TP,1608	
C367	2203-005005	C-CERAMIC,CHIP	100nF,10%,16V,X7R,TP,1608	
C368	2203-001607	C-CERAMIC,CHIP	0.22nF,5%,50V,NPO,TP,1608	
C369	2203-001607	C-CERAMIC,CHIP	0.22nF,5%,50V,NPO,TP,1608	
C370	2203-001607	C-CERAMIC,CHIP	0.22nF,5%,50V,NPO,TP,1608	
C371	2203-001607	C-CERAMIC,CHIP	0.22nF,5%,50V,NPO,TP,1608	
C380	2203-000257	C-CERAMIC,CHIP	10nF,10%,50V,X7R,TP,1608	
C381	2203-000257	C-CERAMIC,CHIP	10nF,10%,50V,X7R,TP,1608	
C382	2203-000257	C-CERAMIC,CHIP	10nF,10%,50V,X7R,TP,1608	

Loc. No.	Code No.	Description	Specification	Remarks
C383	2203-000280	C-CERAMIC,CHIP	0.01nF,0.5pF,50V,NP0,TP,1608	
C384	2203-000280	C-CERAMIC,CHIP	0.01nF,0.5pF,50V,NP0,TP,1608	
C403	2203-005005	C-CERAMIC,CHIP	100nF,10%,16V,X7R,TP,1608	
C404	2203-005005	C-CERAMIC,CHIP	100nF,10%,16V,X7R,TP,1608	
C405	2203-005005	C-CERAMIC,CHIP	100nF,10%,16V,X7R,TP,1608	
C410	2402-001042	C-AL,SMD	100uF,20%,16V,GP,TP,6.6x6.6x5.4mm	
C416	2203-000257	C-CERAMIC,CHIP	10nF,10%,50V,X7R,TP,1608	
C417	2402-000108	C-AL,SMD	10uF,20%,16V,WT,TP,4.3x4.3x5.4	
C423	2203-000626	C-CERAMIC,CHIP	0.022nF,5%,50V,NP0,TP,1608	
C424	2203-000626	C-CERAMIC,CHIP	0.022nF,5%,50V,NP0,TP,1608	
C513	2203-005005	C-CERAMIC,CHIP	100nF,10%,16V,X7R,TP,1608	
C521	2402-000176	C-AL,SMD	10uF,20%,16V,GP,TP,4.3x4.3x5.4	
C533	2203-000257	C-CERAMIC,CHIP	10nF,10%,50V,X7R,TP,1608	
C541	2203-000257	C-CERAMIC,CHIP	10nF,10%,50V,X7R,TP,1608	
C545	2203-005005	C-CERAMIC,CHIP	100nF,10%,16V,X7R,TP,1608	
C620	2402-001044	C-AL,SMD	100uF,20%,25V,-,TP,8.3x8.3x6.3	
C630	2402-000135	C-AL,SMD	22uF,20%,16V,GP,TP,5.3x5.3x5.4	
C631	2203-005005	C-CERAMIC,CHIP	100nF,10%,16V,X7R,TP,1608	
C632	2203-005005	C-CERAMIC,CHIP	100nF,10%,16V,X7R,TP,1608	
C633	2203-005005	C-CERAMIC,CHIP	100nF,10%,16V,X7R,TP,1608	
C634	2203-005005	C-CERAMIC,CHIP	100nF,10%,16V,X7R,TP,1608	
C635	2203-005005	C-CERAMIC,CHIP	100nF,10%,16V,X7R,TP,1608	
C636	2203-005005	C-CERAMIC,CHIP	100nF,10%,16V,X7R,TP,1608	
C637	2203-005005	C-CERAMIC,CHIP	100nF,10%,16V,X7R,TP,1608	
C638	2203-005005	C-CERAMIC,CHIP	100nF,10%,16V,X7R,TP,1608	
C639	2203-005005	C-CERAMIC,CHIP	100nF,10%,16V,X7R,TP,1608	
C640	2203-005005	C-CERAMIC,CHIP	100nF,10%,16V,X7R,TP,1608	
C641	2203-005005	C-CERAMIC,CHIP	100nF,10%,16V,X7R,TP,1608	
C642	2203-005005	C-CERAMIC,CHIP	100nF,10%,16V,X7R,TP,1608	
C643	2203-001607	C-CERAMIC,CHIP	0.22nF,5%,50V,NP0,TP,1608	
C644	2203-001607	C-CERAMIC,CHIP	0.22nF,5%,50V,NP0,TP,1608	
C645	2203-001607	C-CERAMIC,CHIP	0.22nF,5%,50V,NP0,TP,1608	
C646	2203-001607	C-CERAMIC,CHIP	0.22nF,5%,50V,NP0,TP,1608	
C647	2203-001607	C-CERAMIC,CHIP	0.22nF,5%,50V,NP0,TP,1608	
C648	2203-001607	C-CERAMIC,CHIP	0.22nF,5%,50V,NP0,TP,1608	
C649	2203-000998	C-CERAMIC,CHIP	0.047nF,5%,50V,NP0,TP,1608	
C652	2203-000384	C-CERAMIC,CHIP	0.015nF,5%,50V,NP0,TP,1608	
C653	2203-000257	C-CERAMIC,CHIP	10nF,10%,50V,X7R,TP,1608	
C654	2203-000257	C-CERAMIC,CHIP	10nF,10%,50V,X7R,TP,1608	
C655	2203-000257	C-CERAMIC,CHIP	10nF,10%,50V,X7R,TP,1608	
C656	2203-000257	C-CERAMIC,CHIP	10nF,10%,50V,X7R,TP,1608	
C657	2402-000179	C-AL,SMD	47uF,20%,16V,GP,TP,6.6x6.6x5.4	
C661	2203-000626	C-CERAMIC,CHIP	0.022nF,5%,50V,NP0,TP,1608	
C662	2203-000626	C-CERAMIC,CHIP	0.022nF,5%,50V,NP0,TP,1608	
C668	2203-005005	C-CERAMIC,CHIP	100nF,10%,16V,X7R,TP,1608	
C670	2402-001044	C-AL,SMD	100uF,20%,25V,-,TP,8.3x8.3x6.3	
C671	2402-000179	C-AL,SMD	47uF,20%,16V,GP,TP,6.6x6.6x5.4	
C672	2402-000176	C-AL,SMD	10uF,20%,16V,GP,TP,4.3x4.3x5.4	
C673	2402-001042	C-AL,SMD	100uF,20%,16V,GP,TP,6.6x6.6x5.4mm	
C674	2203-005005	C-CERAMIC,CHIP	100nF,10%,16V,X7R,TP,1608	
C675	2203-005005	C-CERAMIC,CHIP	100nF,10%,16V,X7R,TP,1608	

Loc. No.	Code No.	Description	Specification	Remarks
C676	2203-005005	C-CERAMIC,CHIP	100nF,10%,16V,X7R,TP,1608	
C677	2203-005005	C-CERAMIC,CHIP	100nF,10%,16V,X7R,TP,1608	
C678	2203-005005	C-CERAMIC,CHIP	100nF,10%,16V,X7R,TP,1608	
C679	2203-005005	C-CERAMIC,CHIP	100nF,10%,16V,X7R,TP,1608	
C680	2203-005005	C-CERAMIC,CHIP	100nF,10%,16V,X7R,TP,1608	
C681	2203-000257	C-CERAMIC,CHIP	10nF,10%,50V,X7R,TP,1608	
C682	2203-000257	C-CERAMIC,CHIP	10nF,10%,50V,X7R,TP,1608	
C683	2203-000257	C-CERAMIC,CHIP	10nF,10%,50V,X7R,TP,1608	
C687	2402-001044	C-AL,SMD	100uF,20%,25V,-,TP,8.3x8.3x6.3	
C688	2402-001044	C-AL,SMD	100uF,20%,25V,-,TP,8.3x8.3x6.3	
C689	2203-005005	C-CERAMIC,CHIP	100nF,10%,16V,X7R,TP,1608	
C690	2203-005005	C-CERAMIC,CHIP	100nF,10%,16V,X7R,TP,1608	
C691	2203-000257	C-CERAMIC,CHIP	10nF,10%,50V,X7R,TP,1608	
C692	2203-000257	C-CERAMIC,CHIP	10nF,10%,50V,X7R,TP,1608	
C693	2203-000257	C-CERAMIC,CHIP	10nF,10%,50V,X7R,TP,1608	
C694	2203-000257	C-CERAMIC,CHIP	10nF,10%,50V,X7R,TP,1608	
CN101	3711-000556	CONNECTOR-HEADER	BOX,12P,1R,1.25mm,SMD-A,SN	SNA
CN402	3711-004070	CONNECTOR-HEADER	BOX,30P,1R,1.25mm,SMD-A,SN	SNA
CN504A	3708-000461	CONNECTOR-FPC/FFC/PIC	8P,1mm,SMD,AUF	SNA
CN505	3711-001141	CONNECTOR-HEADER	BOX,9P,1R,1.25mm,SMD-S,SN	SNA
D201	0401-001056	DIODE-SWITCHING	MMBD4148SE,75V,200MA,SOT-23,TP	
D202	0401-001056	DIODE-SWITCHING	MMBD4148SE,75V,200MA,SOT-23,TP	
D203	0401-001056	DIODE-SWITCHING	MMBD4148SE,75V,200MA,SOT-23,TP	
D205	0403-000579	DIODE-ZENER	BZX84C5V1,5.1V,5%,200mW,SOT-23	
D206	0403-000579	DIODE-ZENER	BZX84C5V1,5.1V,5%,200mW,SOT-23	
D209	0403-000579	DIODE-ZENER	BZX84C5V1,5.1V,5%,200mW,SOT-23	
D210	0403-000579	DIODE-ZENER	BZX84C5V1,5.1V,5%,200mW,SOT-23	
D267	0402-000553	DIODE-RECTIFIER	SS24,40V,2.0A,DO-214AA	
FT120	3301-001145	CORE-FERRITE BEAD	AB,4.5x1.6x1.6mm,-,-	SNA
FT121	3301-001145	CORE-FERRITE BEAD	AB,4.5x1.6x1.6mm,-,-	SNA
FT122	3301-001145	CORE-FERRITE BEAD	AB,4.5x1.6x1.6mm,-,-	SNA
FT301	2901-001114	FILTER-EMI SMD	25VDC,2.0ADC,-,100nF,3.2x1.6x1	
FT302	2901-001114	FILTER-EMI SMD	25VDC,2.0ADC,-,100nF,3.2x1.6x1	
FT303	2901-001114	FILTER-EMI SMD	25VDC,2.0ADC,-,100nF,3.2x1.6x1	
FT304	2901-001114	FILTER-EMI SMD	25VDC,2.0ADC,-,100nF,3.2x1.6x1	
FT305	2901-001114	FILTER-EMI SMD	25VDC,2.0ADC,-,100nF,3.2x1.6x1	
FT407	2901-001114	FILTER-EMI SMD	25VDC,2.0ADC,-,100nF,3.2x1.6x1	
FT408	2901-001114	FILTER-EMI SMD	25VDC,2.0ADC,-,100nF,3.2x1.6x1	
FT413	3301-001145	CORE-FERRITE BEAD	AB,4.5x1.6x1.6mm,-,-	SNA
FT414	3301-001145	CORE-FERRITE BEAD	AB,4.5x1.6x1.6mm,-,-	SNA
FT415	3301-001145	CORE-FERRITE BEAD	AB,4.5x1.6x1.6mm,-,-	SNA
FT416	2901-001114	FILTER-EMI SMD	25VDC,2.0ADC,-,100nF,3.2x1.6x1	
FT417	3301-001145	CORE-FERRITE BEAD	AB,4.5x1.6x1.6mm,-,-	SNA
FT418	3301-001145	CORE-FERRITE BEAD	AB,4.5x1.6x1.6mm,-,-	SNA
IC104	1203-001890	IC-VOLTAGE REGULATOR	3961,SOT223-5,5P,-,PLASTIC,2.5V,-,40to+125C,800mA,-,TR	
IC301	0904-001585	IC-GRAPHIC CONT.	GM5020 01H,-,BGA,292P,1063MIL,160MHZ,TR,CMOS,PLASTIC,2.5V,19.1W,0TO+70C,-,-,10	
IC401	1205-002174	IC-TRANSMITTER	NT7181,TSSOP,56P,236MIL,PLASTIC,3.45V,-,0TO+70C,TP,NT7181	
IC402	1205-002174	IC-TRANSMITTER	NT7181,TSSOP,56P,236MIL,PLASTIC,3.45V,-,0TO+70C,TP,NT7181	
IC502	1103-001023	IC-EEPROM	524C80D81,1028x8Bit,SOP,8P,150MIL,10ms,5V,10%,PLASTIC,0to+70C,110uA,CMOS,TP	
IC507	0803-000117	IC-TTL	74F14,INVERTER,SOP,14P,150MIL,	
IC510	1203-001293	IC-POSI.FIXED REG.	033,TO-252,3P,6.5MIL,PLASTIC,3	

Loc. No.	Code No.	Description	Specification	Remarks
IC512	1105-001165	IC-DRAM	416S1020,512Kx16BITx2,TSOP,50P	
IC513	1105-001165	IC-DRAM	416S1020,512Kx16BITx2,TSOP,50P	
IC514	1105-001165	IC-DRAM	416S1020,512Kx16BITx2,TSOP,50P	
IC520	0403-001435	DIODE-ZENER	QZX363C5V6,5.32-5.88,200MW,SOT-363,TP	
IC521	0903-001266	IC-MICROCONTROLLER	NT60F63,8BIT,PLCC,44P,653MIL,12MHZ,ST,CMOS,PLASTIC,5V,-,0TO+70C,256B,4KB,-,MC	
IC522	1203-001488	IC-POSI.FIXED REG.	7805,T0-252,3P,-,PLASTIC,4.8/5	
IC523	1203-001293	IC-POSI.FIXED REG.	033,T0-252,3P,6.5MIL,PLASTIC,3	
IC524	0505-001170	FET-SILICON	SI9933ADY-T1,P,-20V,3.4A,0.06ohm,2W,SO-8	
IC525	0403-001435	DIODE-ZENER	QZX363C5V6,5.32-5.88,200MW,SOT-363,TP	
IC740	0505-001170	FET-SILICON	SI9933ADY-T1,P,-20V,3.4A,0.06ohm,2W,SO-8	
IC741	1203-001779	IC-POSI.FIXED REG.	7812,D2PAK,3P,-,PLASTIC,11.5/12.5V,-,40TO+125CC,1A,-,TP	
IC742	0403-001435	DIODE-ZENER	QZX363C5V6,5.32-5.88,200MW,SOT-363,TP	
JP1	2007-000090	R-CHIP	10KOHM,5%,1/16W,DA,TP,1608	
JP12	2007-000090	R-CHIP	10KOHM,5%,1/16W,DA,TP,1608	
JP14	2007-000090	R-CHIP	10KOHM,5%,1/16W,DA,TP,1608	
JP15	2007-000090	R-CHIP	10KOHM,5%,1/16W,DA,TP,1608	
JP17	2007-000090	R-CHIP	10KOHM,5%,1/16W,DA,TP,1608	
JP19	2007-000090	R-CHIP	10KOHM,5%,1/16W,DA,TP,1608	
JP21	2007-000090	R-CHIP	10KOHM,5%,1/16W,DA,TP,1608	
JP24	2007-000090	R-CHIP	10KOHM,5%,1/16W,DA,TP,1608	
JP26	2007-000090	R-CHIP	10KOHM,5%,1/16W,DA,TP,1608	
JP27	2007-000090	R-CHIP	10KOHM,5%,1/16W,DA,TP,1608	
JP3	2007-000090	R-CHIP	10KOHM,5%,1/16W,DA,TP,1608	
JP5	2007-000090	R-CHIP	10KOHM,5%,1/16W,DA,TP,1608	
JP7	2007-000090	R-CHIP	10KOHM,5%,1/16W,DA,TP,1608	
JP9	2007-000090	R-CHIP	10KOHM,5%,1/16W,DA,TP,1608	
MP1.1	BN41-00200A	PCB MAIN	GH19BS,FR4,MP1.0,1.6T,138*107*1.6T,GH19BS	SNA
Q108	0501-000342	TR-SMALL SIGNAL	KSC1623-Y,NPN,200mW,SOT-23,TP,135-270	
Q109	0505-001170	FET-SILICON	SI9933ADY-T1,P,-20V,3.4A,0.06ohm,2W,SO-8	
Q110	0501-000342	TR-SMALL SIGNAL	KSC1623-Y,NPN,200mW,SOT-23,TP,135-270	
R203	2007-001164	R-CHIP	75ohm,1%,1/16W,DA,TP,1608	
R204	2007-001164	R-CHIP	75ohm,1%,1/16W,DA,TP,1608	
R205	2007-001164	R-CHIP	75ohm,1%,1/16W,DA,TP,1608	
R211	2007-000074	R-CHIP	100ohm,5%,1/16W,DA,TP,1608	
R218	2007-000092	R-CHIP	15Kohm,5%,1/16W,DA,TP,1608	
R219	2007-000092	R-CHIP	15Kohm,5%,1/16W,DA,TP,1608	
R230	2007-000074	R-CHIP	100ohm,5%,1/16W,DA,TP,1608	
R231	2007-000090	R-CHIP	10KOHM,5%,1/16W,DA,TP,1608	
R300	2007-000078	R-CHIP	1Kohm,5%,1/16W,DA,TP,1608	
R309	2007-000287	R-CHIP	100OHM,1%,1/10W,DA,TP,1608	
R310	2007-000287	R-CHIP	100OHM,1%,1/10W,DA,TP,1608	
R311	2007-000287	R-CHIP	100OHM,1%,1/10W,DA,TP,1608	
R340	2007-001167	R-CHIP	75ohm,5%,1/16W,DA,TP,1608	
R341	2007-001167	R-CHIP	75ohm,5%,1/16W,DA,TP,1608	
R342	2007-001167	R-CHIP	75ohm,5%,1/16W,DA,TP,1608	
R343	2007-001167	R-CHIP	75ohm,5%,1/16W,DA,TP,1608	
R415	2007-000070	R-CHIP	0ohm,5%,1/16W,DA,TP,1608	
R503	2007-000074	R-CHIP	100ohm,5%,1/16W,DA,TP,1608	
R506	2007-000074	R-CHIP	100ohm,5%,1/16W,DA,TP,1608	
R507	2007-000074	R-CHIP	100ohm,5%,1/16W,DA,TP,1608	
R508	2007-000074	R-CHIP	100ohm,5%,1/16W,DA,TP,1608	

Loc. No.	Code No.	Description	Specification	Remarks
R509	2007-000074	R-CHIP	100ohm,5%,1/16W,DA,TP,1608	
R511	2007-000084	R-CHIP	4.7Kohm,5%,1/16W,DA,TP,1608	
R512	2007-000084	R-CHIP	4.7Kohm,5%,1/16W,DA,TP,1608	
R514	2007-000084	R-CHIP	4.7Kohm,5%,1/16W,DA,TP,1608	
R520	2007-000074	R-CHIP	100ohm,5%,1/16W,DA,TP,1608	
R521	2007-000074	R-CHIP	100ohm,5%,1/16W,DA,TP,1608	
R582	2007-000075	R-CHIP	220ohm,5%,1/16W,DA,TP,1608	
R592	2007-000124	R-CHIP	2.2Kohm,5%,1/16W,DA,TP,1608	
R655	2007-001167	R-CHIP	75ohm,5%,1/16W,DA,TP,1608	
R664	2007-000118	R-CHIP	390ohm,5%,1/16W,DA,TP,1608	
R665	2007-000074	R-CHIP	100ohm,5%,1/16W,DA,TP,1608	
R666	2007-000118	R-CHIP	390ohm,5%,1/16W,DA,TP,1608	
R668	2007-000084	R-CHIP	4.7Kohm,5%,1/16W,DA,TP,1608	
R669	2007-000084	R-CHIP	4.7Kohm,5%,1/16W,DA,TP,1608	
R670	2007-000084	R-CHIP	4.7Kohm,5%,1/16W,DA,TP,1608	
R671	2007-000084	R-CHIP	4.7Kohm,5%,1/16W,DA,TP,1608	
R672	2007-000074	R-CHIP	100ohm,5%,1/16W,DA,TP,1608	
R673	2007-000074	R-CHIP	100ohm,5%,1/16W,DA,TP,1608	
R682	2007-000077	R-CHIP	470ohm,5%,1/16W,DA,TP,1608	
R683	2007-000077	R-CHIP	470ohm,5%,1/16W,DA,TP,1608	
R684	2007-000077	R-CHIP	470ohm,5%,1/16W,DA,TP,1608	
R692	2007-000084	R-CHIP	4.7Kohm,5%,1/16W,DA,TP,1608	
R693	2007-000078	R-CHIP	1Kohm,5%,1/16W,DA,TP,1608	
R694	2007-000077	R-CHIP	470ohm,5%,1/16W,DA,TP,1608	
R695	2007-000109	R-CHIP	1Mohm,5%,1/16W,DA,TP,1608	
R698	2007-000072	R-CHIP	47ohm,5%,1/16W,DA,TP,1608	
R701	2007-000074	R-CHIP	100ohm,5%,1/16W,DA,TP,1608	
R703	2007-000074	R-CHIP	100ohm,5%,1/16W,DA,TP,1608	
R704	2007-000074	R-CHIP	100ohm,5%,1/16W,DA,TP,1608	
R705	2007-000074	R-CHIP	100ohm,5%,1/16W,DA,TP,1608	
R706	2007-000074	R-CHIP	100ohm,5%,1/16W,DA,TP,1608	
R707	2007-000074	R-CHIP	100ohm,5%,1/16W,DA,TP,1608	
R709	2007-000074	R-CHIP	100ohm,5%,1/16W,DA,TP,1608	
R710	2007-000090	R-CHIP	10KOHM,5%,1/16W,DA,TP,1608	
R711	2007-000090	R-CHIP	10KOHM,5%,1/16W,DA,TP,1608	
R712	2007-000090	R-CHIP	10KOHM,5%,1/16W,DA,TP,1608	
R713	2007-000074	R-CHIP	100ohm,5%,1/16W,DA,TP,1608	
R715	2007-000078	R-CHIP	1Kohm,5%,1/16W,DA,TP,1608	
R716	2007-000287	R-CHIP	1000HM,1%,1/10W,DA,TP,1608	
R717	2007-000287	R-CHIP	1000HM,1%,1/10W,DA,TP,1608	
R718	2007-000287	R-CHIP	1000HM,1%,1/10W,DA,TP,1608	
R720	2007-000074	R-CHIP	100ohm,5%,1/16W,DA,TP,1608	
R721	2007-000090	R-CHIP	10KOHM,5%,1/16W,DA,TP,1608	
R722	2007-000084	R-CHIP	4.7Kohm,5%,1/16W,DA,TP,1608	
R723	2007-001044	R-CHIP	56ohm,5%,1/16W,DA,TP,1608	
R724	2007-001044	R-CHIP	56ohm,5%,1/16W,DA,TP,1608	
R725	2007-001044	R-CHIP	56ohm,5%,1/16W,DA,TP,1608	
R726	2007-001044	R-CHIP	56ohm,5%,1/16W,DA,TP,1608	
R727	2007-001044	R-CHIP	56ohm,5%,1/16W,DA,TP,1608	
R728	2007-001044	R-CHIP	56ohm,5%,1/16W,DA,TP,1608	
R729	2007-001044	R-CHIP	56ohm,5%,1/16W,DA,TP,1608	

Loc. No.	Code No.	Description	Specification	Remarks
R730	2007-001044	R-CHIP	56ohm,5%,1/16W,DA,TP,1608	
R731	2007-001044	R-CHIP	56ohm,5%,1/16W,DA,TP,1608	
R732	2007-001044	R-CHIP	56ohm,5%,1/16W,DA,TP,1608	
R733	2007-001044	R-CHIP	56ohm,5%,1/16W,DA,TP,1608	
R734	2007-001044	R-CHIP	56ohm,5%,1/16W,DA,TP,1608	
R735	2007-001044	R-CHIP	56ohm,5%,1/16W,DA,TP,1608	
R736	2007-001044	R-CHIP	56ohm,5%,1/16W,DA,TP,1608	
R737	2007-001044	R-CHIP	56ohm,5%,1/16W,DA,TP,1608	
R738	2007-001044	R-CHIP	56ohm,5%,1/16W,DA,TP,1608	
R739	2007-001044	R-CHIP	56ohm,5%,1/16W,DA,TP,1608	
R740	2007-001044	R-CHIP	56ohm,5%,1/16W,DA,TP,1608	
R741	2007-001044	R-CHIP	56ohm,5%,1/16W,DA,TP,1608	
R742	2007-001044	R-CHIP	56ohm,5%,1/16W,DA,TP,1608	
R750	2007-000090	R-CHIP	10KOHM,5%,1/16W,DA,TP,1608	
R751	2007-000090	R-CHIP	10KOHM,5%,1/16W,DA,TP,1608	
R752	2007-000084	R-CHIP	4.7Kohm,5%,1/16W,DA,TP,1608	
R753	2007-000074	R-CHIP	100ohm,5%,1/16W,DA,TP,1608	
R754	2007-000074	R-CHIP	100ohm,5%,1/16W,DA,TP,1608	
R790	2007-000074	R-CHIP	100ohm,5%,1/16W,DA,TP,1608	
R791	2007-000090	R-CHIP	10KOHM,5%,1/16W,DA,TP,1608	
R792	2007-000074	R-CHIP	100ohm,5%,1/16W,DA,TP,1608	
R793	2007-000074	R-CHIP	100ohm,5%,1/16W,DA,TP,1608	
R794	2007-000078	R-CHIP	1Kohm,5%,1/16W,DA,TP,1608	
RA301	2011-001410	R-NETWORK	1200HM,5%,1/16W,L,CHIP,8P,TP	
RA302	2011-001410	R-NETWORK	1200HM,5%,1/16W,L,CHIP,8P,TP	
RA303	2011-001410	R-NETWORK	1200HM,5%,1/16W,L,CHIP,8P,TP	
RA304	2011-001410	R-NETWORK	1200HM,5%,1/16W,L,CHIP,8P,TP	
RA305	2011-001410	R-NETWORK	1200HM,5%,1/16W,L,CHIP,8P,TP	
RA306	2011-001410	R-NETWORK	1200HM,5%,1/16W,L,CHIP,8P,TP	
RA307	2011-001410	R-NETWORK	1200HM,5%,1/16W,L,CHIP,8P,TP	
RA308	2011-001410	R-NETWORK	1200HM,5%,1/16W,L,CHIP,8P,TP	
RA309	2011-001410	R-NETWORK	1200HM,5%,1/16W,L,CHIP,8P,TP	
RA310	2011-001410	R-NETWORK	1200HM,5%,1/16W,L,CHIP,8P,TP	
RA311	2011-001410	R-NETWORK	1200HM,5%,1/16W,L,CHIP,8P,TP	
RA312	2011-001410	R-NETWORK	1200HM,5%,1/16W,L,CHIP,8P,TP	
X301	2801-003326	CRYSTAL-SMD	24MHz,30ppm,28-ABX,16pF,50ohm,	
X302	2801-003773	CRYSTAL-SMD	12MHZ,30PPM,28-AAN,20PF,50OHM,TP	
ZD1	0403-000579	DIODE-ZENER	BZX84C5V1,5.1V,5%,200mW,SOT-23	
ZD2	0403-000579	DIODE-ZENER	BZX84C5V1,5.1V,5%,200mW,SOT-23	

6-2 Others

Loc. No.	Code No.	Description	Specification	Remarks
- C/F	BN90-00346A BN90-00016N	ASSY COVER FRONT ASSY COVER FRONT	GH19AS, GH19AS-SXM8/0001 GH19AS, ABS HB IV16, SILVER	
- C/R	BN90-00347A BN63-00306C	ASSY COVER REAR COVER-REAR	GH19AS, GH19AS-SXM8/0001 GH19AS, ABS HB BL21, S33-595-A1114S	SNA
-	BN90-00408D	ASSY STAND	GH19BSCBV/XSJ, SEJ, ABS HB, BK07	
CIS	BN96-00150A	ASSY MISC P-STAND PIVOT	GH17AS	SNA
-	BN91-00311D	ASSY LCD	GH19PS, -, -, -	SNA
CIS	0203-001318	TAPE CONDUCTOR	DK-K102-100-140, TO.13, W140, L80, GRAY	SNA
CIS	BN07-00057A	LCD	LTM190E1-L01, GH17LS, 1280*1024, 404*330*20, 16.7M, 36.0, 0.098*0.294, 0-50, 5.0, PVA, -	
-	BN91-00428A	ASSY CHASSIS	GH19AS, GH19AS-SXM8/0001	
-	BN91-00429A	ASSY SHIELD	GH19AS, GH19AS-SXM8/0001	SNA
CIS	0203-001159	TAPE-FILAMENT	#8915, TO.15, W12, L55000, CLR	SNA
CIS	0203-001304	TAPE-AL FOIL	DK100-50-170, TO.7, W50, L170, SIL	SNA
SH/PCB+PANEL	6001-000364	SCREW-MACHINE	FH, +, M3, L8, ZPC(YEL), SM20C, -	SNA
SH/PCB+SH/LVDS	6003-000117	SCREW-TAPTITE	BH, +, B, M3, L6, ZPC(YEL), SWRCH18A	SNA
SIGNAL	BN39-00244A	CBF SIGNAL	BU15A0(T541A), 15P/15P, 20276-N, 1830MM, UL20276, BLACK, D.SUB/MALE, DET. TYPE	
CIS	BN63-00309A	SHIELD-LVDS	GH19PS, SPT, TO.3	SNA
CIS	BN68-00195Z	LABEL-MARK	SEC(E) PANNEL, ART-PAPER 100G, -, 30, 10, -, BLK, WHT, -, -	SNA
-	BN92-00487A	ASSY BOX	GH19AS	SNA
BOX	BH75-10529C	UNIT-HANDLE/PACKING	S/M170MP, PE-LD, PE-HD, -, WHITE, -	
CIS	BN72-60001A	LEVER TOP	LSD210TL, PE-LD, WHITE, TFT_LCD	SNA
CIS	BN72-60002C	LEVER BOTTOM	S/M170MP, PE-HD, BLUE	SNA
BOX	BN68-00134D	LABEL BAR CODE	-, ALL, TCO99, W/W, ART-PAPER 90G, -, WHT, BLACK, -, -, -	SNA
BOX	BN69-00404A	BOX	S/M191N, W/W, CB-SW4, YEL, A-1, L521*W501*H258	SNA
-	BN92-00488A	ASSY LABEL	GH19AS, GH19AS-SXM8/0001	SNA
LABEL	BN68-00219A	LABEL RATING	W/W, BARCODE, PE, TO.05, 60, 35, SYNC, -, PE NATURE, -, -	SNA
LABEL	BN68-00286A	LABEL RATING	GH19BS, W/W, PE, TO.05, 90, 30, SYNC, PE NATURE	SNA
-	BN92-00489A	ASSY ACCESSORY	GH19AS, GH19AS-SXM8/0001	SNA
-	BN92-00532A	ASSY P/MATERIAL	GH19BS	SNA
CIS	0203-001157	TAPE-OPP MASKING	OPP/W75/CLR, TO.05, W75, L100000,	SNA
CIS	BH69-00256A	PAD-PACKING-EDGE	MV540, B400, 200, 2170, -, -, YEL, -, -	SNA
CIS	BH69-00457B	PACKING-PAD	GH15, FOAM, T3.0, 930, 1000	SNA
CIS	BH69-30355C	BAG-FPD	HDPE+PE FOAM, 0.02+0.5, -, Y(24), -, IBM	SNA
CIS	BH69-40303L	PACKING-PALLET	WOOD, 1020*994*130, -, ML15NS	SNA
CIS	BH69-40319A	PACKING-PAD	DW-2, -, CSD5577, -, -, -, -, -	SNA
CIS	BH69-40379A	PACKING-WRAP	LDPE, W500*TO.02, -, -	SNA
CIS	BN68-00129A	LABEL SHIPPING	-, LABEL SHIPPING, ART-PAPER, 100G, -, WHT, BLACK, -, -, -	SNA
CIS	BN69-00319A	CUSHION-R/L	GH19PS: (IN POWER), EPS M50	SNA

7 Block Diagram

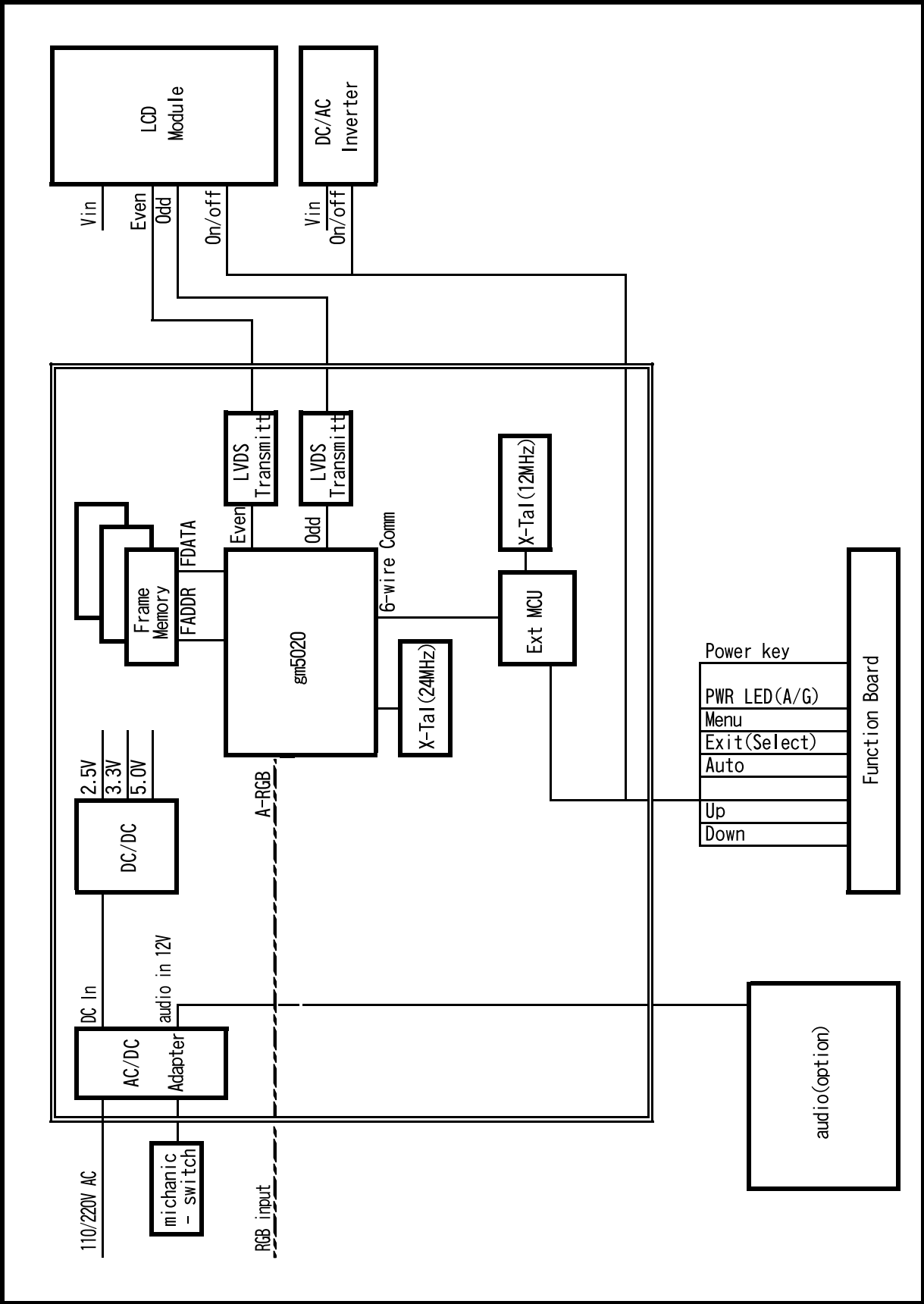

Memo

8 Wiring Diagram

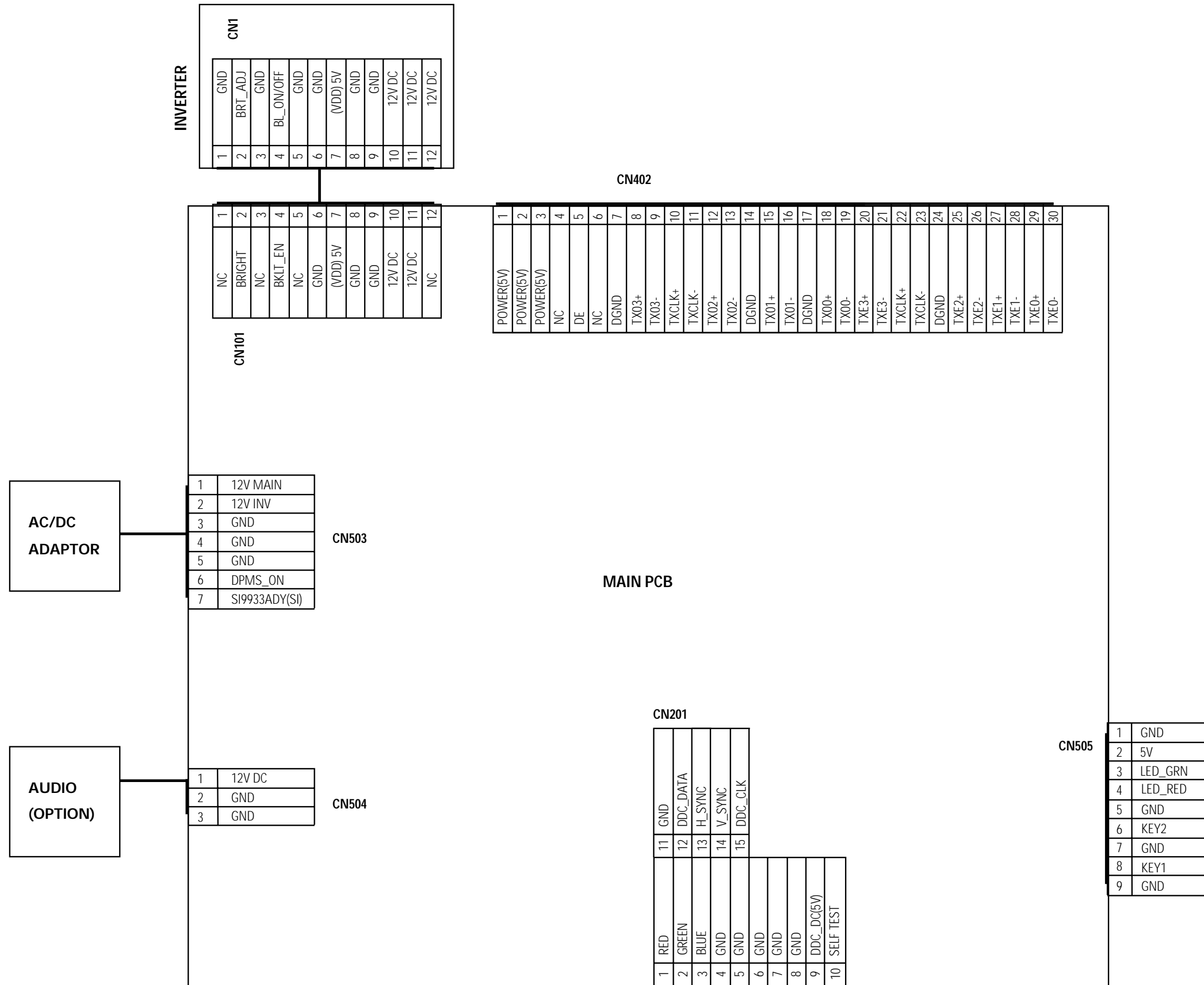

Memo

CONFIDENTIAL

9-2 GH19A* Part Schematic Diagram

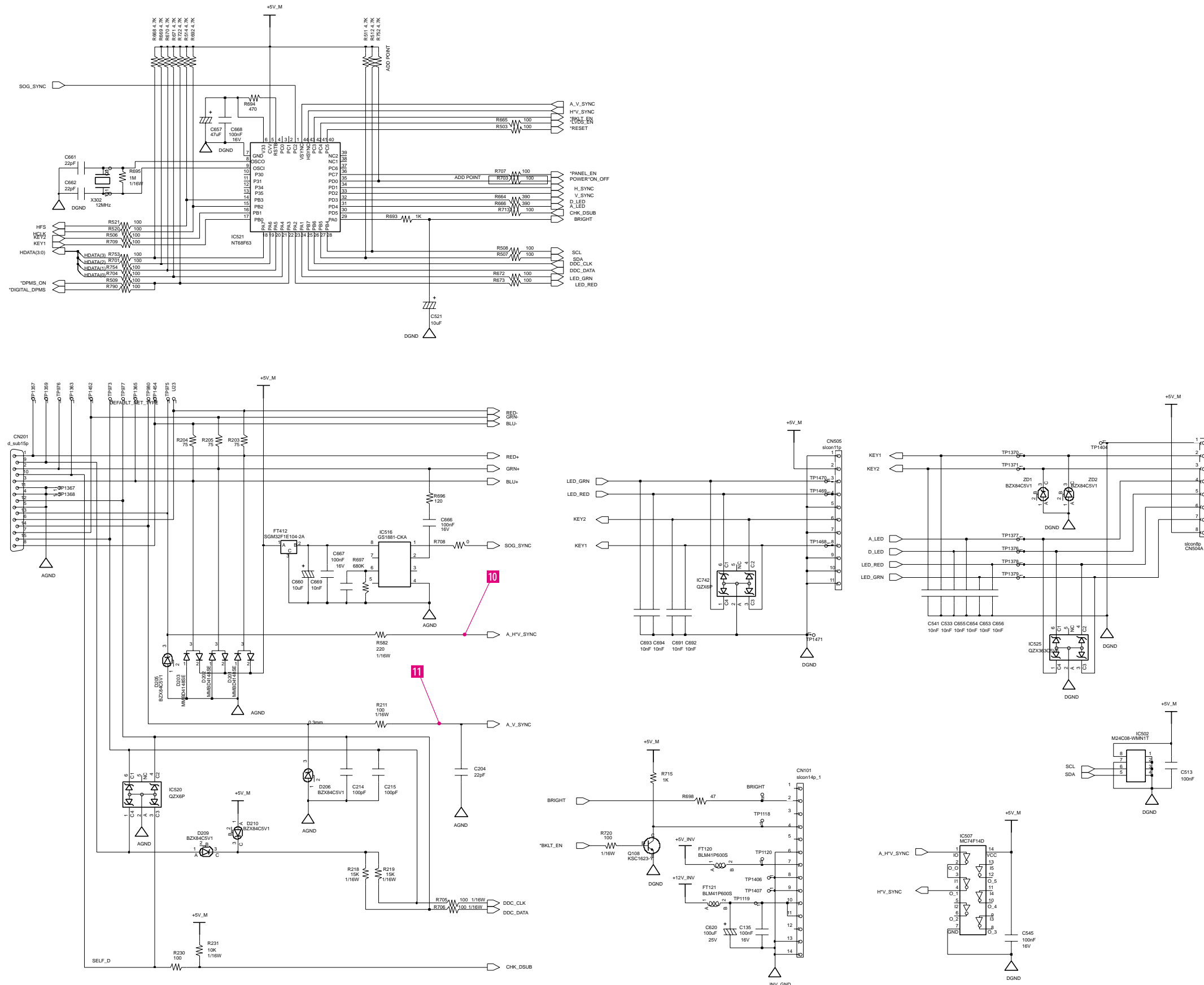

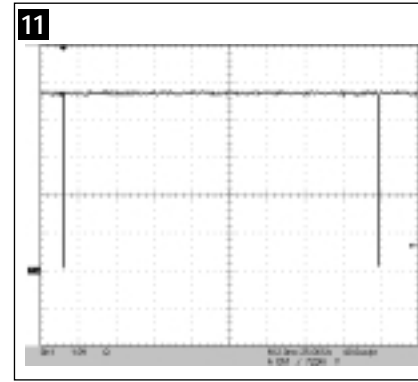
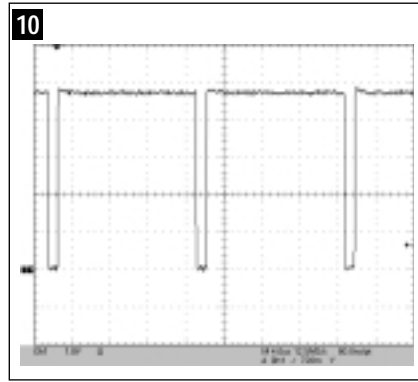

9-3 GH19A* Part Schematic Diagram

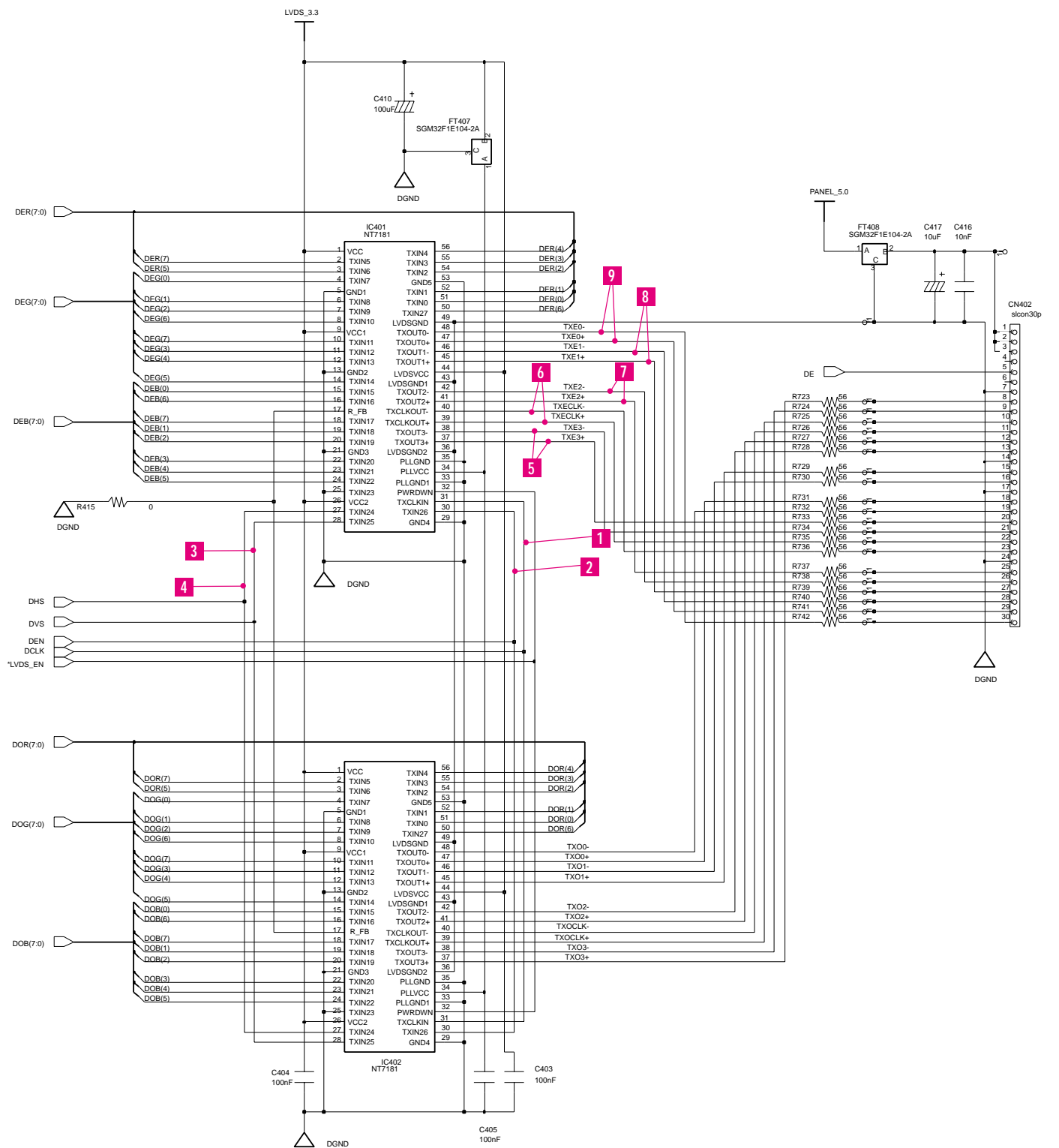
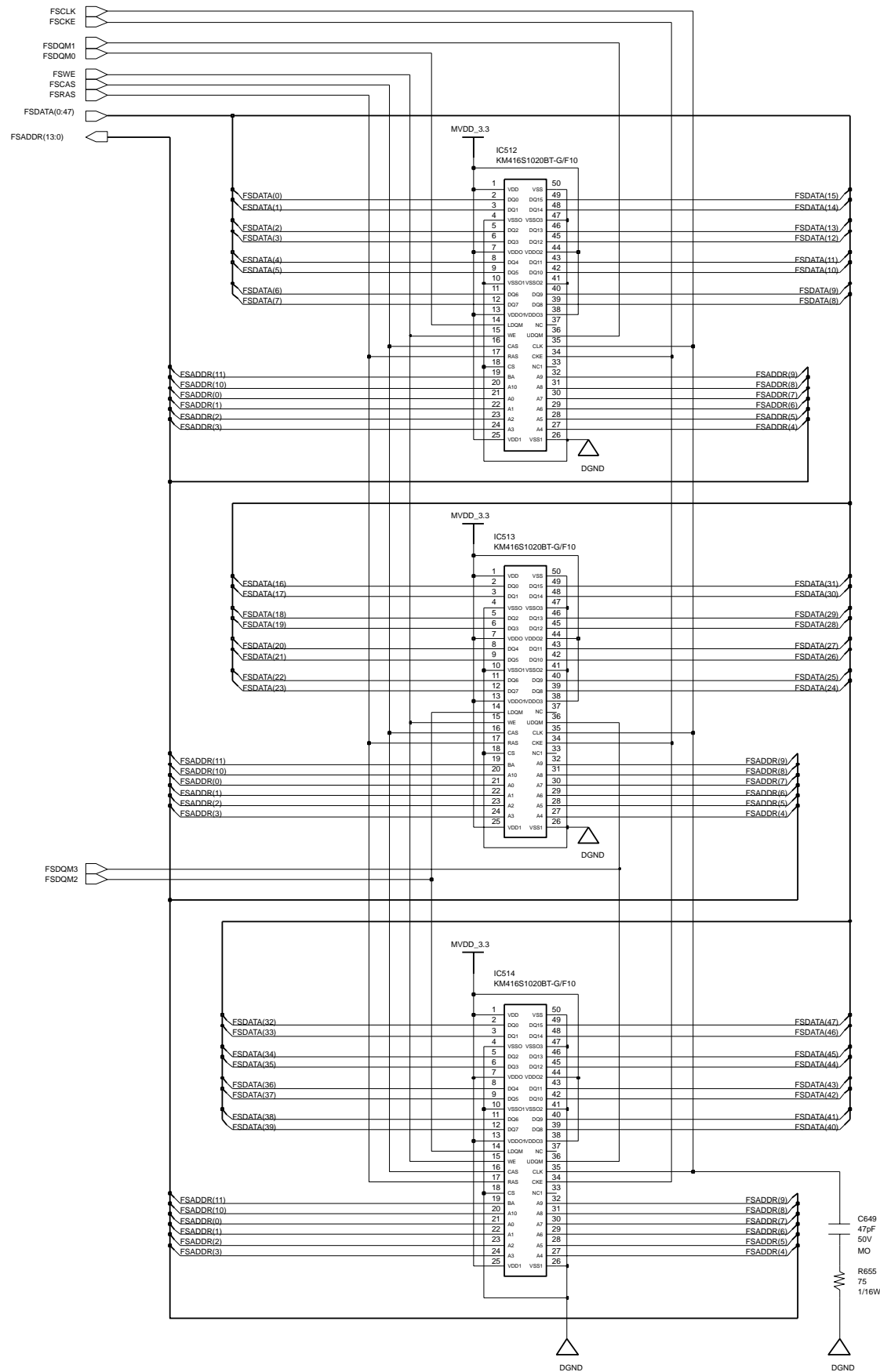

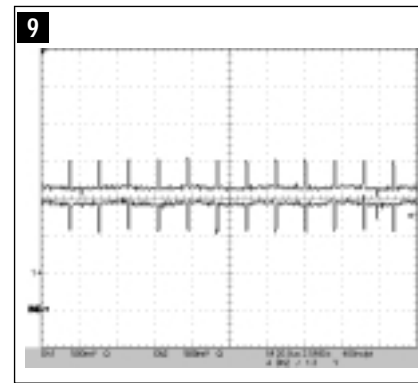
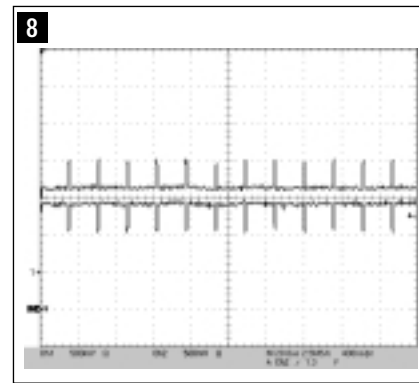
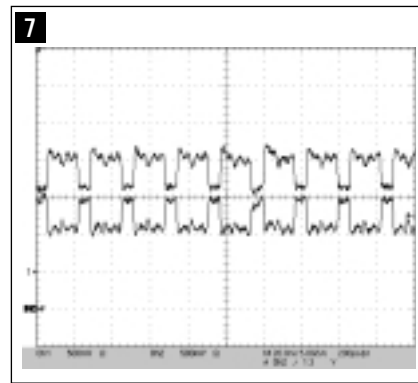
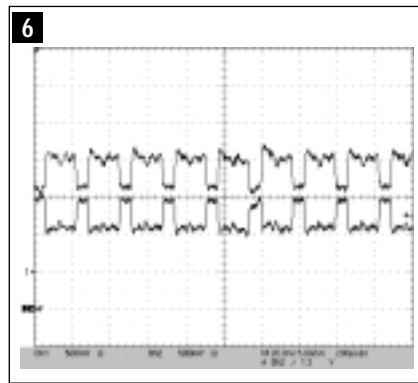
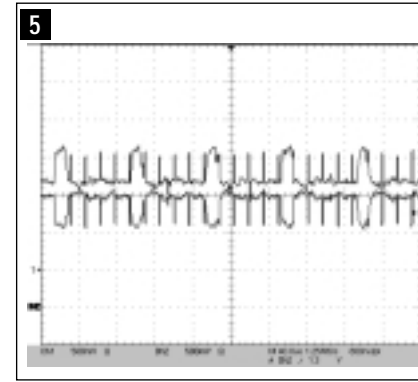
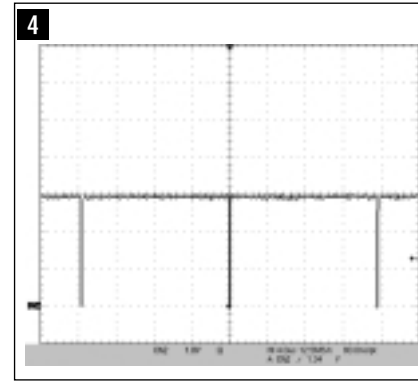
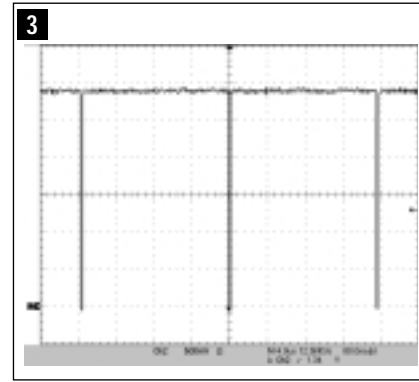
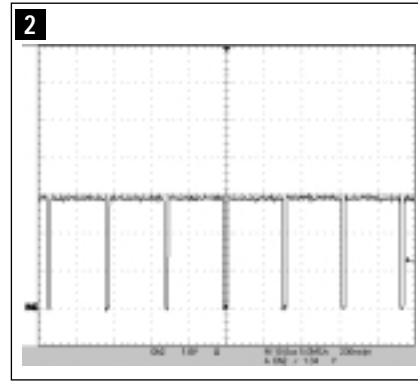
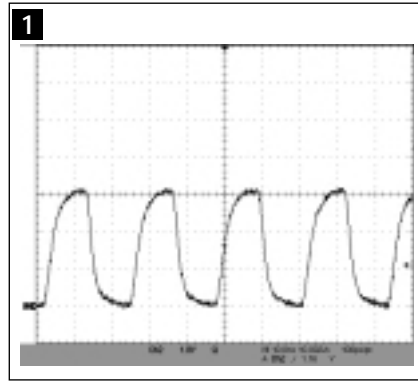

9-4 GH19A* Part Schematic Diagram

