

Service Manual

17" LCD MONITOR DELL E176FPc



THESE DOCUMENTS ARE FOR REPAIR SERVICE INFORMATION ONLY. EVERY REASONABLE EFFORT HAS BEEN MADE TO ENSURE THE ACCURACY OF THIS MANUAL; WE CANNOT GUARANTEE THE ACCURACY OF THIS INFORMATION AFTER THE DATE OF PUBLICATION AND DISCLAIMS RELIABILITY FOR CHANGES, ERRORS OR OMISSIONS.

Revision List

Revision	Release Date	Revise history	TPV model
A00	Aug.-26-2005	Initial Release	T780KCDHK8DLNP
			T780KGDHK8DZNP
			T780KGDHK8DENP
A01	Mar.-31-2006	Add” Definition Of Pixel Defects ”	
A02	April-25-2006	Add” Max Brightness measurement ” on Page49	
A03	Mar.-30-2007	Add Mechanical Instruction in item 6	
A04	Dec.-20--2007	Add the CBPC,PWPC Version information in BOM list	All

Table of contents	
Table of contents	03
1. Monitor Specifications	04
2. LCD Monitor Description	05
3. Operation instructions	06
3.1 General Instructions	06
3.2 Control buttons	06
3.3 On Screen Menu/Display (OSD)	07
3.4 Adjusting the Picture	08
4. Input/Output Specification	13
4.1 Input Signal Connector	13
4.2 Factory Preset Display Modes	13
4.3 Power Supply Requirements	14
4.4 Panel Specification	15
5. Block Diagram	18
5.1 Monitor Exploded View	18
5.2 Software Flow Chart	19
5.3 Electrical Block Diagram	21
6. Mechanical Instruction	23
7. Schematic Diagram	28
7.1 Main Board	28
7.2 Power Board	33
8. Layout	35
8.1 Main Board	35
8.2 Power Board	37
8.3 Key Board	40
9. Maintainability	41
9.1 Equipments and Tools Requirement	41
9.2 Trouble Shooting	42
10. White Balance Adjustment	48
11. EDID Content	49
12. ISP User Manual	50
12.1 Connect ISP Writer preparation action	50
12.2 To Use ISP WRITER	51
12.3 Executing ISP	55
13. Check List	56
14. BOM List	59
15. Definition Of Pixel Defects	70

1. Monitor Specifications

LCD Panel	Screen type	Active matrix - TFT LCD
	Panel Type	LM170E01-TLB3/TLB4 (LPL) CLAA170EA07 (CPT)
	Size	430mm(17.0")
	Pixel pitch	0.264mm(H) x 0.264mm(V)
	Viewable angle (CR>=10)	LM170E01-TLB3/TLB4: 70°/70° (H) 75°/65° (V) (typ.) CLAA170EA07: 70°/70° (H) 67°/63° (V) (typ.)
	Response time	LM170E01-TLB3/TLB4: 8ms(type) CLAA170EA07: 12ms(type)
Input	Video	R, G, B Analog Interface
	Separate Sync	H/V TTL
	H-Frequency	30kHz – 80kHz
	V-Frequency	55 - 75Hz
Display Colors		16.2M Colors
Dot Clock		135MHz(Max)
Max. Resolution		1280 x 1024
Plug & Play		VESA DDC
EPA ENERGY STAR®	ON Mode	<45W
	OFF Mode	<2W
Input Connector		D-Sub 15pin
Input Video Signal		Analog:0. 7Vp-p(standard) 75 OHM, Positive
Maximum Screen Size		Horizontal : 337.92mm Vertical: 270.336mm
Power Source		100 V ~ 240 V± 10 %VAC, 50 ± 3Hz, 60 ± 3Hz
Environmental Considerations		Operating Temp: 5° to 35°C Operating Humidity: 10% to 80% Storage Temp.: -20° to 60°C
Weight	Monitor (Stand and Head): 5.2kg (11.5 lb)	
	Monitor Flat panel only (VESA Mode): 4.0 kg (8.8 lb)	
	Weight with packaging: 6.4 kg (14.1 lb)	

2. LCD Monitor Description

The LCD MONITOR will contain a main board, PWPC board, keypad board, which house the flat panel control logic, brightness control logic and DDC.

The power board will provide AC to DC Inverter voltage to drive the backlight of panel and the main board chips each voltage.

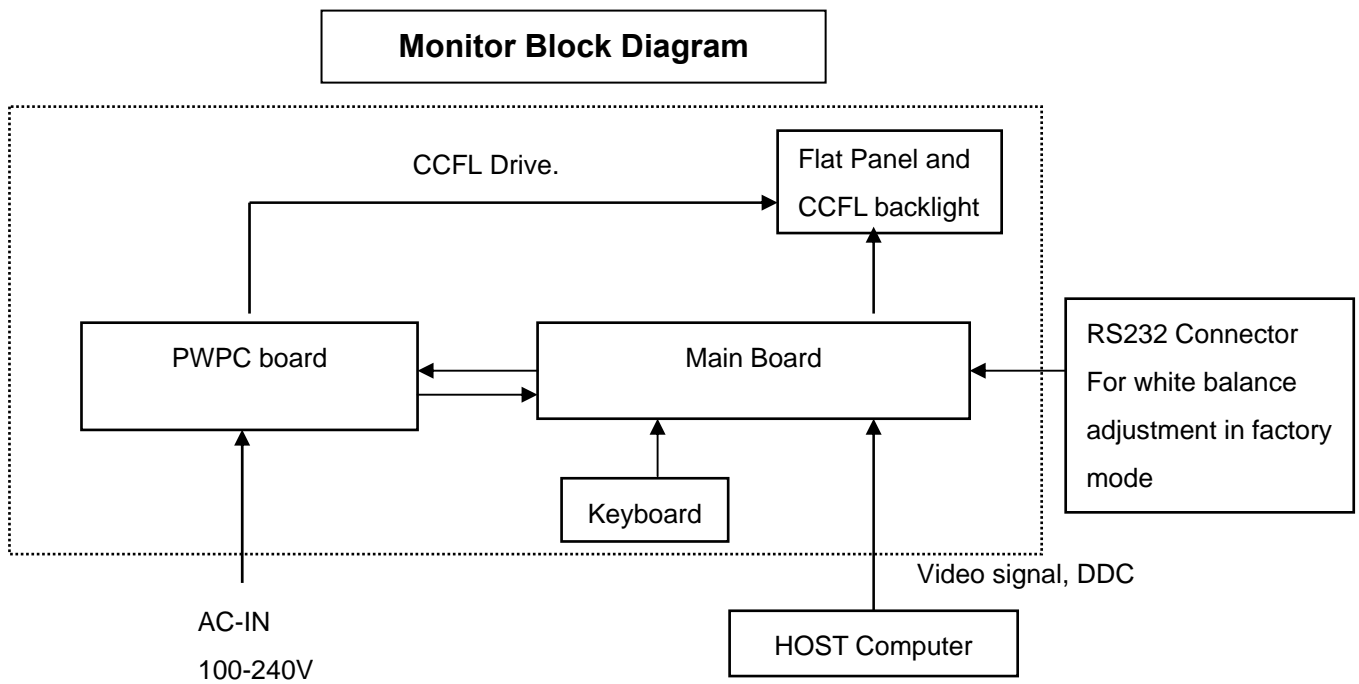

3. Operation instructions

3.1 General Instructions







Press the power button to turn the monitor on or off. The other control buttons are located at front panel of the monitor. By changing these settings, the picture can be adjusted to your personal preferences.

- The power cord should be connected.
- Connect the video cable from the monitor to the video card.
- Press the power button to turn on the monitor, the power indicator will light up.

3.2 Control Buttons









- 1 Menu selection button
- 2 Brightness Contrast / Down (-) button
- 3 Auto-Adjust / Up (+) button
- 4 Power button On/Off button with indicator

A	 MENU	<p>The 'MENU' button is used to open the on-screen display (OSD), select function icons, exit from menus and sub-menus, and to exit the OSD. See Accessing the Menu System.</p>
B	 Brightness/Contrast Hot Key	<p>Use this button for direct access to the 'Brightness' and 'Contrast' control menu.</p>
B C	 - and + buttons	<p>Use these buttons to adjust (decrease/increase ranges) items in the OSD.</p>
C	 Auto Adjust	<p>Use this button to activate automatic setup and adjustment. The following dialog will appear on screen as the monitor self-adjusts to the current input:</p> <div style="text-align: center; background-color: black; color: white; padding: 5px; margin: 10px 0;">Auto Adjust In Progress</div> <p>Auto Adjustment  button allows the monitor to self-adjust to the incoming video signal. After using 'Auto Adjustment', you can further tune your monitor by using the 'Pixel Clock' and 'Phase' controls in the OSD.</p>
D	 Power Button & Indicator	<p>The green LED indicates the monitor is on and fully functional. An amber LED indicates DPMS power save mode.</p> <p>The Power button turns the monitor on and off.</p>

3.3 On Screen Menu/Display (OSD)

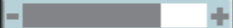
Direct-Access Functions

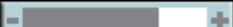
Function	Adjustment Method
<p>Auto adjustment</p>	<p>Use this button to activate automatic setup and adjustment. The following dialog will appear on screen as the monitor self-adjusts to the current input:</p> <div data-bbox="954 488 1382 551" style="background-color: black; color: white; text-align: center; padding: 5px;"> <p>Auto Adjust In Progress</p> </div> <p>Auto Adjustment  button allows the monitor to self-adjust to the incoming video signal. After using 'Auto Adjustment', you can further tune your monitor by using the 'Pixel Clock' and 'Phase' controls in the OSD.</p> <p> NOTE: Auto Adjust will not occur if you press the button while there are no active video input signals, or attached cables</p>
<p>Brightness / Contrast</p>	<p>With the menu off, push  button to display the 'Brightness' and 'Contrast' adjustment menu.</p> <div data-bbox="113 1032 826 1442" style="background-color: black; color: white; padding: 10px;"> <p style="text-align: center; font-weight: bold;">Brightness/Contrast</p> <div style="display: flex; justify-content: space-between; align-items: center;"> <div style="background-color: white; color: black; padding: 5px;">Exit</div>  </div> <div style="display: flex; justify-content: space-between; align-items: center; margin-top: 10px;"> <div style="text-align: center;"> <p>Brightness</p>  </div> <div style="text-align: center;">  <p>75</p> </div> </div> <div style="display: flex; justify-content: space-between; align-items: center; margin-top: 10px;"> <div style="text-align: center;"> <p>Contrast</p>  </div> <div style="text-align: center;">  <p>75</p> </div> </div> </div> <p>The 'Brightness' function adjusts the luminance of the flat panel. Adjust 'Brightness' first, then adjust 'Contrast' only if further adjustment is necessary.</p> <p>"+" increase 'brightness' "-" decrease 'brightness'</p> <p>The 'Contrast' function adjusts the degree of difference between darkness and lightness on the display screen.</p> <p>"+" increase the 'contrast' "-" decrease the 'contrast'</p>





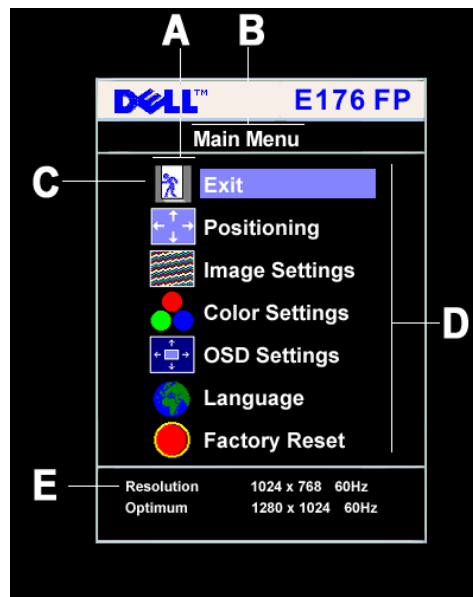





3.4 Adjusting the Picture









1. With the menu off, push the 'MENU' button to open the OSD system and display the main features menu.

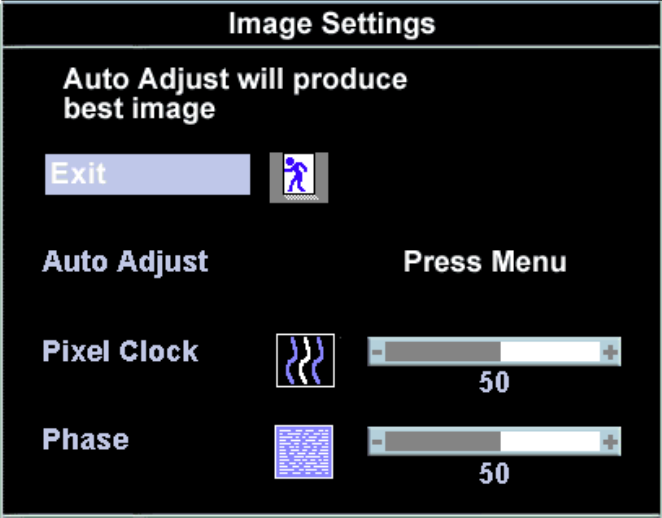





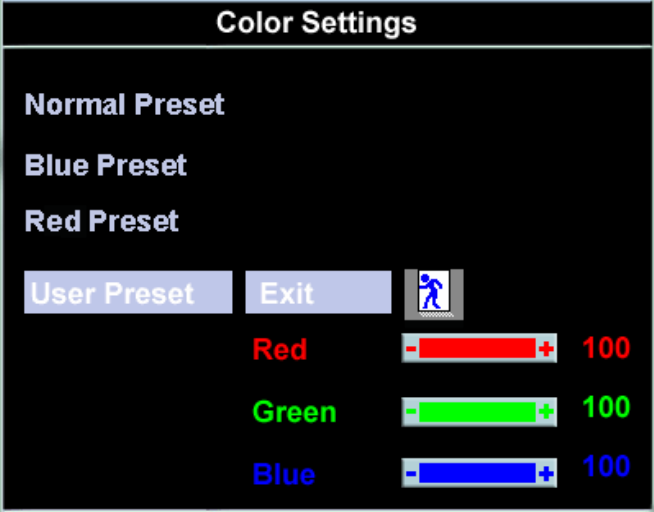



- | | | | | | |
|----------|----------------|----------|------------|----------|-----------|
| A | Function icons | B | Main Menu | C | Menu icon |
| D | Sub-Menu name | E | Resolution | | |

2. Push the - and + buttons to move between the function icons. As you move from one icon to another, the function name is highlighted to reflect the function or group of functions (sub-menus) represented by that icon. See the table below for a complete list of all the functions available for the monitor.
3. Push the 'MENU' button once to activate the highlighted function; Push -/+ to select the desired parameter, push menu to enter the slide bar. Then use the - and + buttons, according to the indicators on the menu, to make your changes.
4. Push the 'Menu' button once to return to the main menu to select another function or push the 'Menu' button two or three times to exit from the OSD.

Icon	Menu Name and Sub-menus	Description
	EXIT	This is used to exit out of the 'Main menu'.
	Positioning: Horizontal Vertical	<p>'Positioning' moves the viewing area around on the monitor screen.</p> <p>When making changes to either the 'Horizontal' or 'Vertical' settings, no changes will occur to the size of the viewing area; the image will simply be shifted in response to your selection/change.</p> <p>Minimum is '0' (-). Maximum is '100' (+).</p> <div data-bbox="464 624 1115 987" style="border: 1px solid black; background-color: black; color: white; padding: 5px;"> <p style="text-align: center; margin: 0;">Positioning</p> <div style="display: flex; justify-content: space-between; align-items: center;"> Exit  </div> <div style="display: flex; justify-content: space-between; align-items: center; margin-top: 10px;"> <div style="text-align: center;"> <p>Horizontal</p>  </div> <div style="text-align: center;">  <p>50</p> </div> </div> <div style="display: flex; justify-content: space-between; align-items: center; margin-top: 10px;"> <div style="text-align: center;"> <p>Vertical</p>  </div> <div style="text-align: center;">  <p>50</p> </div> </div> </div>
	Image settings: Auto Adjust Pixel Clock	<p>Even though your computer system can recognize your new flat panel monitor on startup, the 'Auto Adjustment' function will optimize the display settings for use with your particular setup.</p> <p> <i>NOTE: In most cases, 'Auto Adjust' will produce the best image for your configuration; this function can be directly access via Auto Adjustment</i></p> <p> <i>hotkey.</i></p> <p>The 'Phase' and 'Pixel Clock' adjustments allow you to more closely adjust your monitor to your preference. These settings are accessed through the main OSD menu, by selecting 'Image Settings'.</p> <p>Use the - and + buttons to adjust away interference. Minimum: 0 ~ Maximum: 100</p>

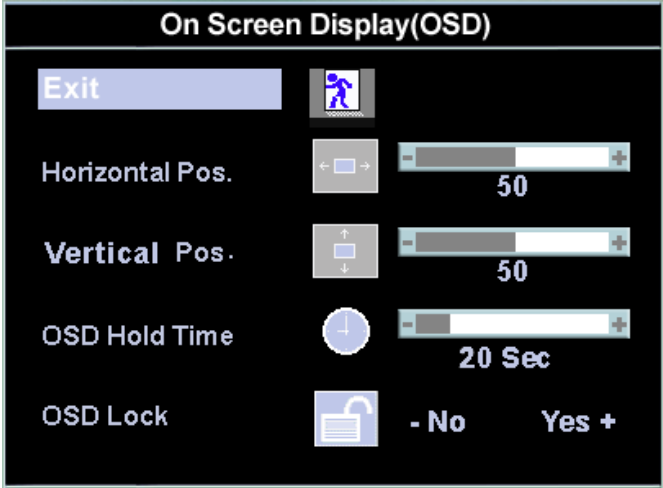
	<p>Phase</p>	<p>If satisfactory results are not obtained using the 'Phase' adjustment, use the 'Pixel Clock' adjustment and then use 'Phase' again.</p>  <p>Image Settings</p> <p>Auto Adjust will produce best image</p> <p>Exit </p> <p>Auto Adjust Press Menu</p> <p>Pixel Clock  50</p> <p>Phase  50</p> <p> NOTE: This function may change the width of the display image. Use the 'Horizontal' function of the 'Position' menu to center the display image on the screen.</p>
	<p>Color Settings:</p>	<p>'Color Settings' adjusts the color temperature and saturation.</p>  <p>Color Settings</p> <p>Normal Preset</p> <p>Blue Preset</p> <p>Red Preset</p> <p>User Preset Exit </p> <p>Red 100</p> <p>Green 100</p> <p>Blue 100</p> <p>Normal Preset</p> <p>'Normal Preset' is selected to obtain the default (factory) color settings.</p> <p>Blue Preset</p> <p>'Blue Preset' is selected to obtain a bluish tint. This color setting is typically used for text based applications (Spreadsheets, Programming, Text Editors etc.).</p> <p>Red Preset</p> <p>'Red Preset' is selected to obtain a redder tint. This color setting is typically used for color intensive applications (Photograph Image Editing, Multimedia, Movies etc.).</p>

	<p>User Preset</p>	<p>'User Preset': Use the plus and minus buttons to increase or decrease each of the three colors (R, G, B) independently, in single digit increments, from '0' to '100'.</p> <p> <i>NOTE: 'Color temperature' is a measure of the 'warmth' of the image colors (red/green/blue). The two available presets ('Blue' and 'Red') favor blue and red accordingly. Select each one to see how each range suits your eye; or utilize the 'User Preset' option to customize the color settings to your exact choice.</i></p>
<p></p> <p></p> <p></p> <p></p>	<p>OSD Settings:</p> <p>Horizontal Position</p> <p>Vertical Position</p> <p>OSD Hold Time:</p> <p>OSD Lock</p>	<p>Each time the OSD opens, it displays in the same location on the screen. 'OSD Settings' (horizontal/vertical) provides control over this location.</p> <p>- and + buttons move OSD to the left and right.</p> <p>- and + buttons move OSD down and up.</p> <p>The OSD stays active for as long as it is in use.</p> <p>'OSD Hold Time': Sets the length of time the OSD will remain active after the last time you pressed a button.</p> <p>Use the - and + buttons to adjust the slider in 5 second increments, from 5 to 60 seconds.</p> <p> <i>NOTE: Default 'OSD hold time' is 20 seconds.</i></p> <p>'OSD Lock': Controls user access to adjustments. When 'Yes' (+) is selected, no user adjustments are allowed. All buttons are locked except the menu button.</p> <p>All buttons can be locked or unlocked press the 'Menu' button for over 15 seconds. to unlock the OSD 'Menu'.</p>
		
<p> <i>NOTE: When the OSD is locked, pressing the 'Menu' button will take the user directly to the 'OSD settings' menu, with 'OSD Lock' preselected on entry. Select 'No'(-) to unlock and allow user access to all applicable settings.</i></p>		

	Language:	<p>Language sets the OSD to display in one of five languages (English, Español, Français, Deutsch, Japanese).</p>  <p> NOTE: The language chosen affects only the language of the OSD. It has no effect on any software running on the computer.</p>
	Factory Reset:	<p>'Factory Reset' returns the settings to the factory preset values for the selected group of functions. 'Exit' is used to exit out of 'Factory Reset' menu.</p> <p>For 'All settings', all user adjustable settings are reset at one time except 'Language settings'.</p>

OSD Warning Messages

A warning message may appear on the screen indicating that the monitor is out of sync.

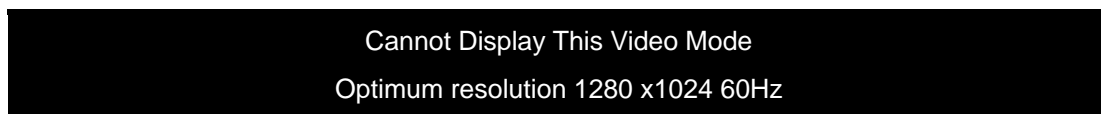

This means that the monitor cannot synchronize with the signal that it is receiving from the computer. Either the signal is too high or too low for the monitor to use. See Specifications for the Horizontal and Vertical frequency ranges addressable by this monitor. Recommended mode is 1280 X 1024 @ 60Hz.

 **NOTE:** The floating 'Dell - self-test Feature Check' dialog will appear on-screen if the monitor cannot sense a video signal.

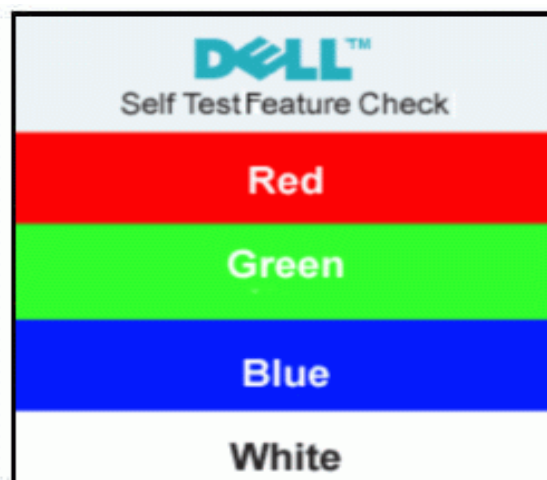

Occasionally, no warning message appears, but the screen is blank. This could also indicate that the monitor is not synchronizing with the computer. See Troubleshooting for more information.

4. Input/Output Specification

4.1 Input Signal Connector

PIN NO.	DESCRIPTION	PIN NO.	DESCRIPTION
1.	Red Video	9.	+5V
2.	Green Video	10.	Logic Ground
3.	Blue Video	11.	RXD
4.	TXD	12.	DDC-Serial Data
5.	Detector Pin	13.	H-Sync
6.	R-Ground	14.	V-Sync
7.	G-Ground	15.	DDC-Serial Clock
8.	B-Ground		

VGA Connector layout

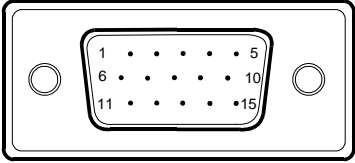

4.2 Factory Preset Display Modes

VESA MODES							
Mode	Resolution	Total	Horizontal		Vertical		Nominal Pixel Clock (MHz)
			Nominal Frequency +/- 0.5kHz	Sync Polarity	Nominal Freq. +/- 1Hz	Sync Polarity	
VGA	640x480@60Hz	800 x 525	31.469	N	59.940	N	25.175
	640x480@75Hz	840 x 500	37.500	N	75.00	N	31.500
	800x600@60Hz	1056 x 628	37.879	P	60.317	P	40.000
	800x600@75Hz	1056x625	46.875	P	75.000	P	49.500
XGA	1024x768@60Hz	1344x806	48.363	N	60.004	N	65.000
	1024x768@75Hz	1312x800	60.023	P	75.029	P	78.750
SXGA	1152x864@75Hz	1600x900	67.500	P	75.000	P	108.00
	1280x1024@60Hz	1688x1066	64.000	P	60.000	P	108.00
	1280x1024@75Hz	1688x1066	79.976	P	75.025	P	135.00
IBM MODES							
Mode	Resolution	Total	Nominal Frequency +/- 0.5kHz	Sync Polarity	Nominal Freq. +/- 1 Hz	Sync Polarity	Nominal Pixel Clock (MHz)
DOS	720x400@70Hz	900 x 449	31.469	N	70.087	P	28.322

4.3 Power Supply Requirements

A/C Line voltage range	100 V ~ 240 V \pm 10 %
A/C Line frequency range	50 \pm 3Hz, 60 \pm 3Hz
Input Voltage transients	280 volts AC for 10 sec @40
Current	0.6A max. at 100V, 0.35A max. at 240 V
Peak surge current	< 60A peak at 240 VAC and cold starting < 30A peak at 120VAC and cold starting
Leakage current	< 3.5mA
Power line surge	No advance effects (no loss of information or defect) with a maximum of 1 half-wave missing per second

4.4 Panel Specification

Display Characteristics (For LM170E01-TLB3 panel)

Active screen size	17.0 inch (43.27cm) diagonal
Outline Dimension	358.5(H) x 296.5(V) x 17.0(D) mm(Typ.)
Pixel Pitch	0.264 mm x 0.264 mm
Pixel Format	1280 horiz. by 1024 vert. Pixels. RGB stripe arrangement
Display Colors	16.2M colors
Luminance, white	300 cd/m ² (Typ. Center 1 point)
Power Consumption	19.4 Watts(Typ.)
Weight	2150g (Typ.)
Display operating mode	Transmissive mode, normally white
Surface treatments	Hard coating (3H), Anti-glare treatment of the front polarizer

Display Characteristics (For LM170E01-TLB4 panel)

Active screen size	17.0 inch (43.27cm) diagonal
Outline Dimension	358.5(H) x 296.5(V) x 17.0(D) mm(Typ.)
Pixel Pitch	0.264 mm x 0.264 mm
Pixel Format	1280 horiz. by 1024 vert. Pixels. RGB stripe arrangement
Display Colors	16.2M colors
Luminance, white	300 cd/m ² (Typ. Center 1 point)
Power Consumption	19.6 Watts(Typ.)
Weight	2150g (Typ.)
Display operating mode	Transmissive mode, normally white
Surface treatments	Hard coating (3H), Anti-glare treatment of the front polarizer

Display Characteristics (For CLAA170EA07 panel)

ITEM	SPECIFICATION
Display Area(mm)	337.920(H)x270.336(V) (17.0-inch diagonal)
Number of Pixels	1280(H)x1024(V)
Pixel Pitch(mm)	0.264(H)x0.264(V)
Color Pixel Arrangement	RGB vertical stripe
Display Mode	normally white, TN
Number of Colors	16.2M(6 Bit+FRC)
Brightness(cd/m ²)	300 cd/m ² (Typ.)(Center point, Lamp current=7.0 mA)
Viewing Angle	140/130(Typ.)
Surface Treatment	Anti-glare
Electrical Interface	LVDS , 2Ch
Total Module Power(W)	20.0 (Typ.)
Optimum Viewing Angle	6 o'clock
Module Size(mm)	358.5(W)x296.5(H)x17.5(D)
Module Weight(g)	2000(typ)
Backlight Unit	CCFL, 4 tables, edge-light(top*2/bottom*2)

4.4.2 Optical Characteristics (For LM170E01- TLB3/TLB4 panel)

Parameter	Symbol	Values			Units	Notes
		Min.	Typ.	Max.		
Contrast ratio	CR	500	700	-		1
Surface luminance, white	L_{WH}	250	300	-	cd/m ²	2
Luminance uniformity	ΔL_{ϕ}	75	-	-	%	3
Response time	T_r		8	18	ms	4
Rise time	T_{rR}	-	2	6		
Decay time	T_{rD}	-	6	12		
CIE color coordinates						
Red	XR	0.605	0.635	0.665		
	YR	0.312	0.342	0.372		
Green	XG	0.262	0.292	0.322		
	YG	0.581	0.611	0.641		
Blue	XB	0.117	0.147	0.177		
	YB	0.040	0.070	0.100		
White	XW	0.283	0.313	0.343		
	YW	0.299	0.329	0.359		
Viewing angle (by CR \geq 10)						
X axis, right ($\phi=0^\circ$)	θ_r	60	70	-	degree	5
X axis, left ($\phi=180^\circ$)	θ_l	60	70	-		
Y axis, up ($\phi=90^\circ$)	θ_u	60	75	-		
Y axis, down ($\phi=270^\circ$)	θ_d	50	65	-		
Viewing angle (by CR \geq 5)						
X axis, right ($\phi=0^\circ$)	θ_r	70	80	-	degree	
X axis, left ($\phi=180^\circ$)	θ_l	70	80	-		
Y axis, up ($\phi=90^\circ$)	θ_u	70	85	-		
Y axis, down ($\phi=270^\circ$)	θ_d	60	75	-		
Relative brightness						6
Luminance uniformity (TCO99)		-	-	1.7		Figure 10

Optical Characteristics (For CLAA170EA07 panel)

Ta=25℃, VCC=5.0V

ITEM	SYMBOL	CONDITION	MIN.	TYP.	MAX.	UNIT	
Contrast Ratio	CR	$\theta = \psi = 0^\circ$	450	500	--	--	
Luminance	Center	L	$\theta = \psi = 0^\circ$	250	300	--	cd/m ²
	Uniformity	ΔL	$\theta = \psi = 0^\circ$	75%	--	--	
Response Time	Tr	$\theta = \psi = 0^\circ$	--	5	10	ms	
	Tf	$\theta = \psi = 0^\circ$	--	7	14	ms	
Viewing Angle	Horizontal	ψ	CR ≥ 5	80/80	85/85	--	°
	Vertical	θ		80/80	85/85	--	°
	Horizontal	ψ	CR ≥ 10	60/60	70/70	--	°
	Vertical	θ		60/55	67/63	--	°
Color Coordinates	White	Wx Wy	$\theta = \psi = 0^\circ$	0.283 0.299	0.313 0.329	0.343 0.359	--
	Red	Rx Ry		0.614 0.308	0.644 0.338	0.674 0.368	
	Green	Gx Gy		0.237 0.592	0.267 0.622	0.297 0.652	
	Blue	Bx By		0.110 0.054	0.140 0.084	0.170 0.114	
Image sticking	Tis	2 hour			2	sec	
Crosstalk	CT				1%		
Flicker	f		--	--	-20	db	
Gamut	CS		69%	72%			
Gamma	γ	GL(32-223)	2.0	2.3	2.6		

5. Block Diagram

5.1 Monitor Exploded View

Index	Parts name	Parts number	Qty	Index	Parts name	Parts number	Qty
1	Bezel	34G1611	1	12	Holder bracket R	15G8185	1
2	Button-Function	33G4884	1	13	Holder bracket L	15G8186	1
3	Rear cover	34G1612	1	14	Shield-Inventor	85G703	1
4	Cover-Vesa	34G1614	1	15	Shield-wire	85G702	1
5	Stand-F	34G1615	1	16	Stand holder	20G027-2	1
6	Stand-B	34G1616	1	17	Stand-diecasting	20G030	1
7	Base	34G1617	1	18	Spring-holder	19G588	2
8	Button-release	33G4885	1	19	Spring-button	19G589	1
9	Mainframe	15G8187	1	20	Hinge	37G535-2	1
10	Base plate	15G8188	1	21	Kensington bkt	15G8146	1
11	Vesa_plate	15G8190	1	22	Rubber foot	12L6097	8

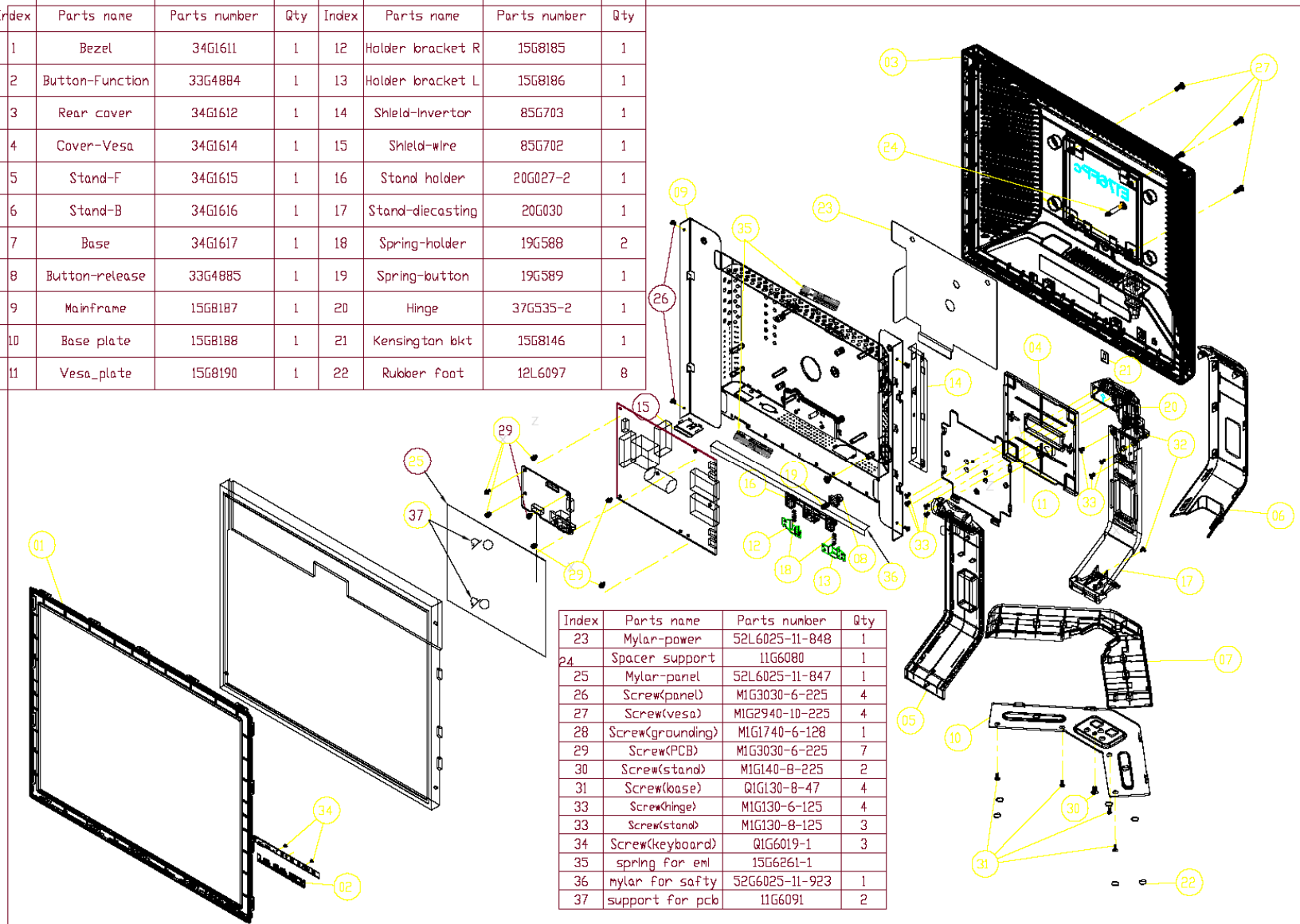

5.2 Software Flow Chart

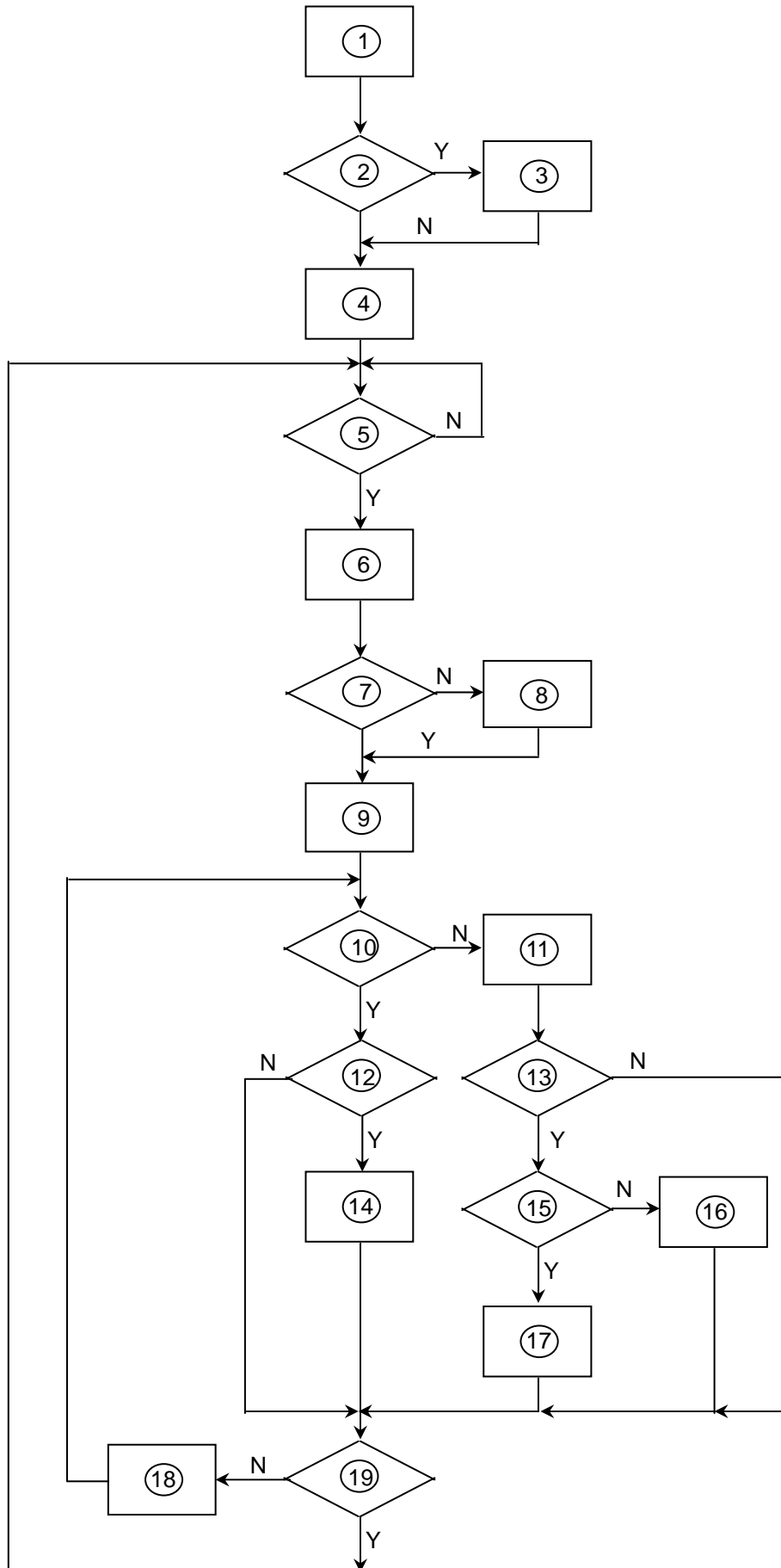

- 1) MCU Initializes.
- 2) Is the EEPROM blank?
- 3) Program the EEPROM by default values.
- 4) Get the PWM value of brightness from EEPROM.
- 5) Is the power key pressed?
- 6) Clear all global flags.
- 7) Are the AUTO and SELECT keys pressed?
- 8) Enter factory mode.
- 9) Save the power key status into EEPROM.
Turn on the LED and set it to green color. Scalar initializes.
- 10) In standby mode?
- 11) Update the lifetime of back light.
- 12) Check the analog port, are there any signals coming?
- 13) Does the scalar send out an interrupt request?
- 14) Wake up the scalar.
- 15) Are there any signals coming from analog port?
- 16) Display "No connection Check Signal Cable" message. And go into standby mode after the message disappears.
- 17) Program the scalar to be able to show the coming mode.
- 18) Process the OSD display.
- 19) Read the keyboard. Is the power key pressed?

5.3 Electrical Block Diagram

5.3.1 Main Board

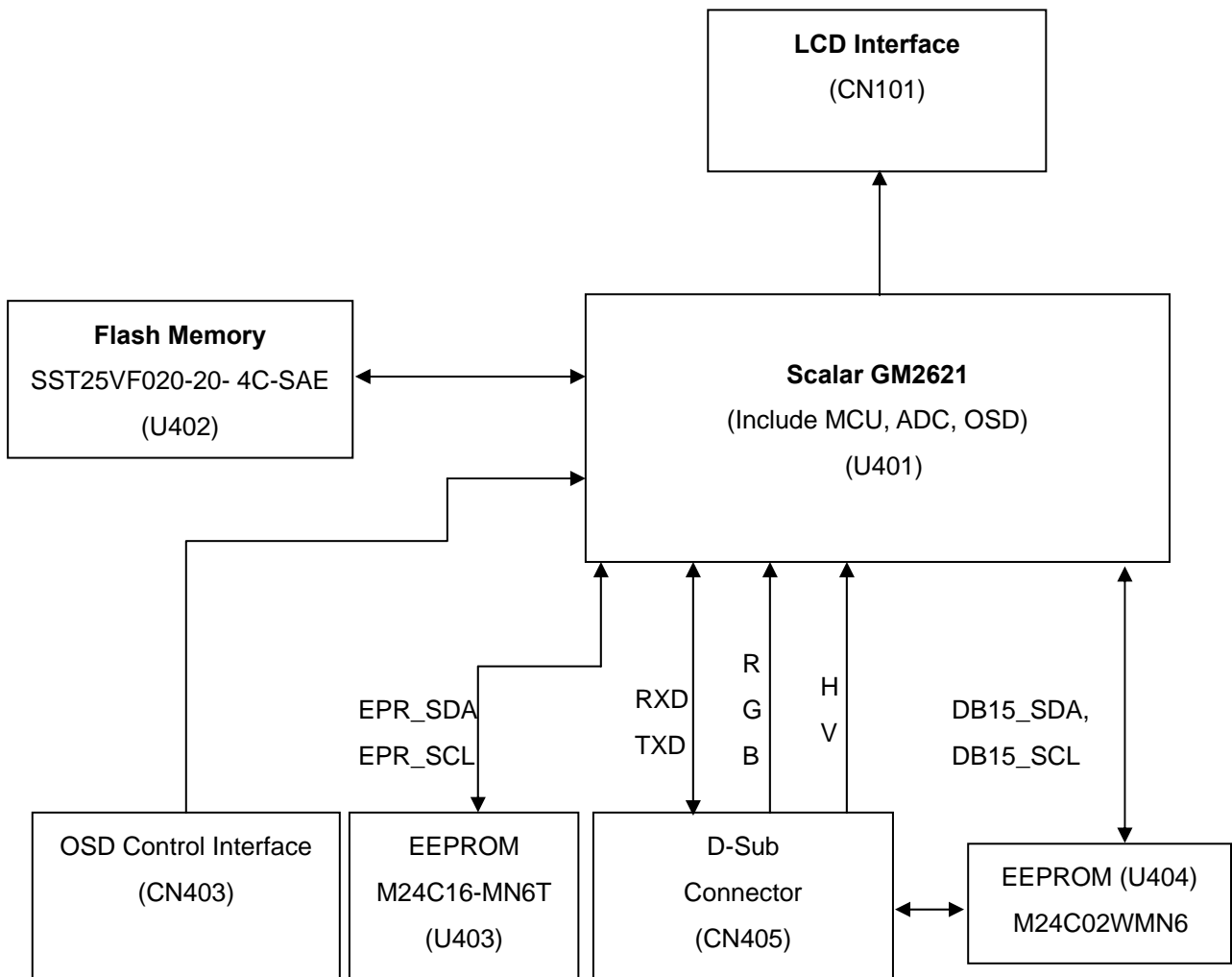

5.3.2 Inverter/Power Board

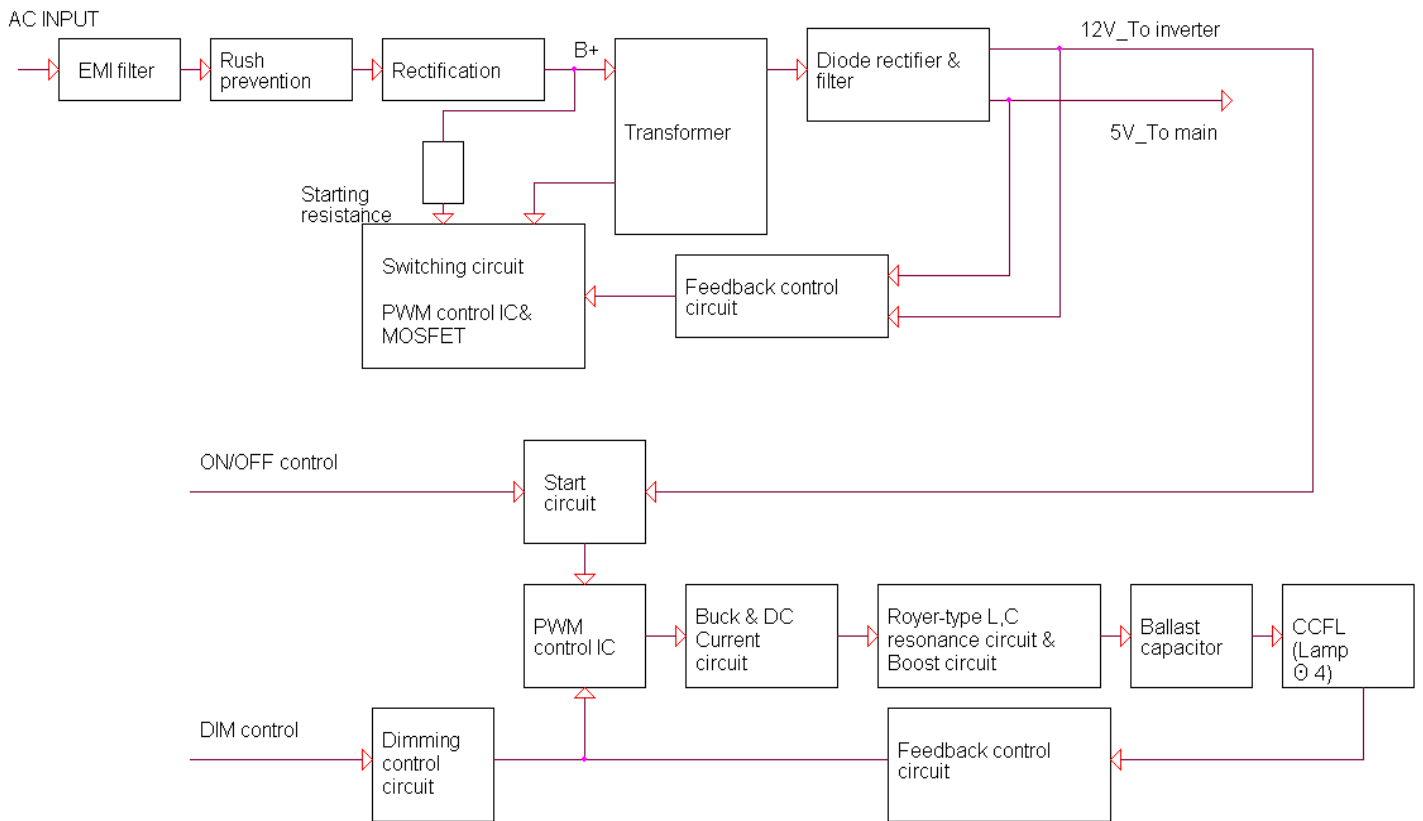

6. Mechanical Instruction

Tools: 2 Power screwdrivers ($\phi=5\text{mm}$, $L=60\text{mm}$); 1 small cross screwdriver; turnbuckle driver;

Setting: Power screwdriver torque A=11 kgF. Cm; torque B=6 kgF. Cm

Note: Firstly, put the monitor on a soft, flat and clean surface, wear gloves.

Fig	Remark
	<p>Remove stand: Press the Stand release button and lift up the Stand and away from the monitor.</p>
	<p>Remove bezel: 1. Remove the 4 screws by torque A</p>
	<p>2. Pry the monitor up then find out the hooks' position, use the tool (like the picture or other card) to insert into the gap of bezel and rear cover.</p>



3. Take off the bezel

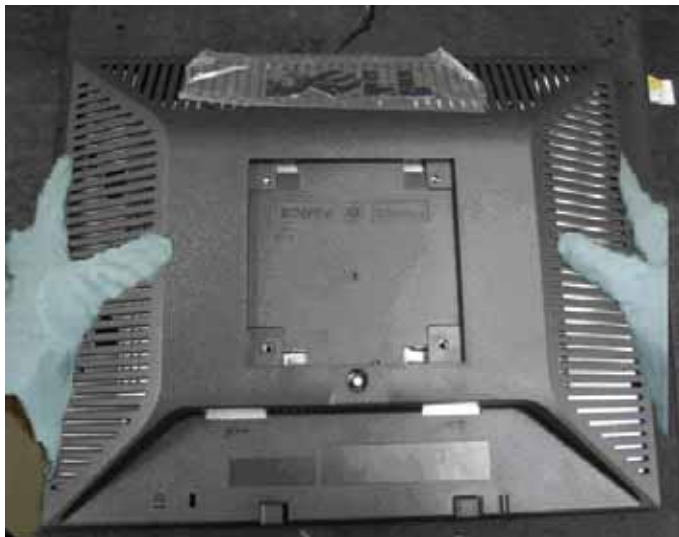

Remove rear cover :

Turn over the monitor as the Fig, hold the rear cover, and then slightly remove it.

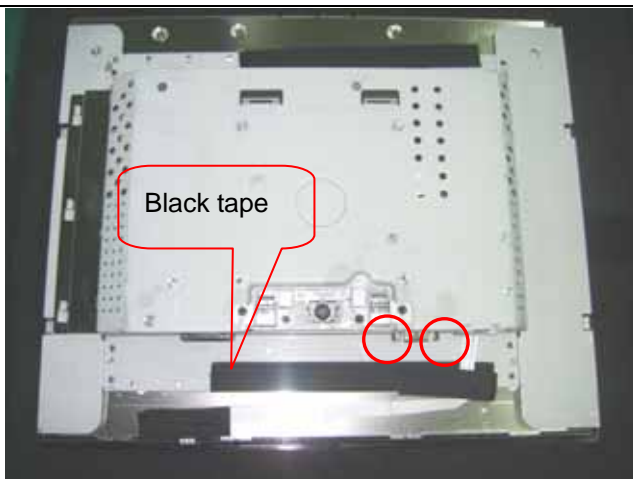



Remove the two screws by

Torque B

Install:

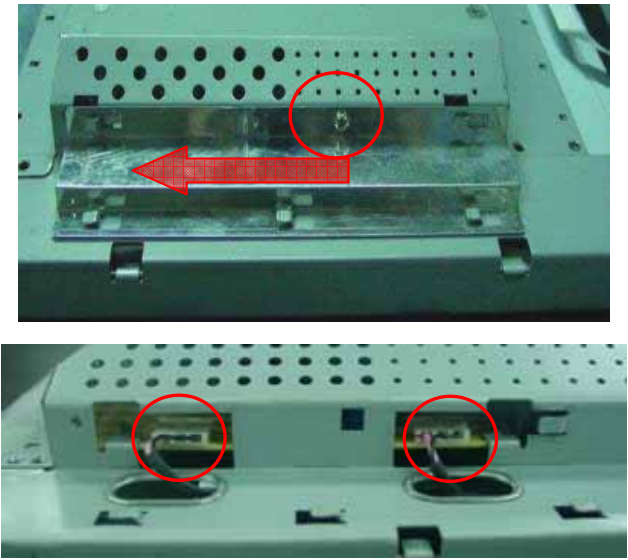
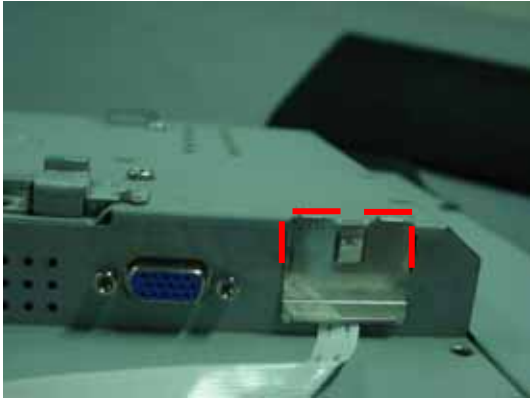
Fix the keyboard cable by black tape as the figure showed.

	<p>Remove the shield :</p> <p>1. Remove the screw by Torque B or by manual and remove the shield ,then remove the back light connector</p>
	<p>Remove the connector</p>
	<p>Remove the two screws by manual or torque = 3kgF.Cm and remove the main frame</p>
	<p>Remove the main frame and at the same time disconnect the LVDS connector and remove the EVA washers</p>

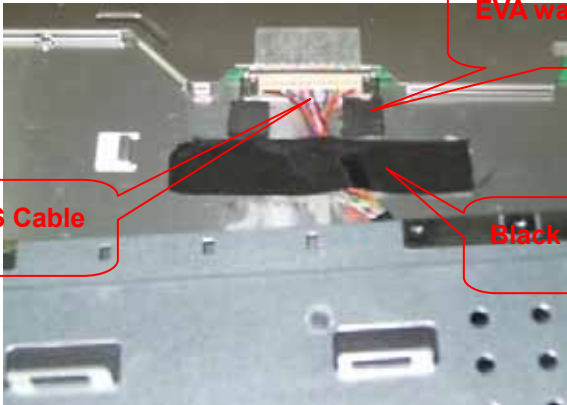
 <p>The image shows a close-up of the LVDS cable being secured to a metal surface. Red callout boxes identify the 'LVDS Cable', 'EVA washers', and 'Black tape' used for the installation.</p>	<p>Install: Fix the LVDS connector by black tape and EVA washers. Note: Make LVDS connector's metal side adown for HYDIS AND LG panel and upturned for AU panel.</p>
---	---

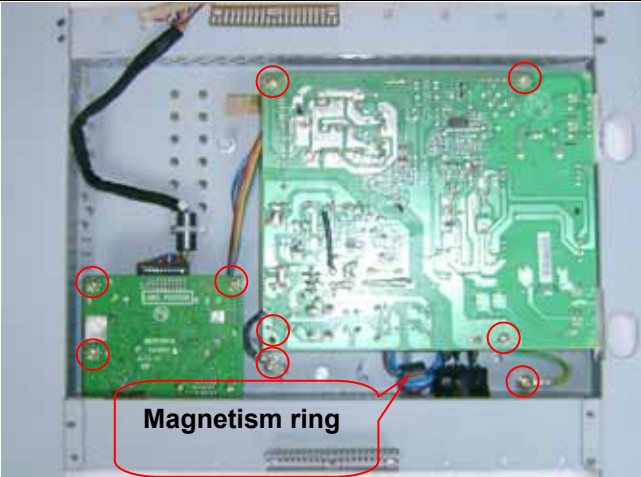
 <p>The image shows the internal components of the monitor, including the main board and power board. Red circles highlight the locations of nine screws. A callout box labeled 'Magnetism ring' points to a ring being placed under the power board.</p>	<p>Remove the nine screws by Torque B and remove the power board and main board. Note: Magnetism ring should be laid underneath the power board</p>
---	--

 <p>The image shows the final assembly with the LVDS cable secured to the metal frame using black tape, as described in the instructions.</p>	<p>Install: Fix the LVDS cable by black tape as the figure.</p>
--	--

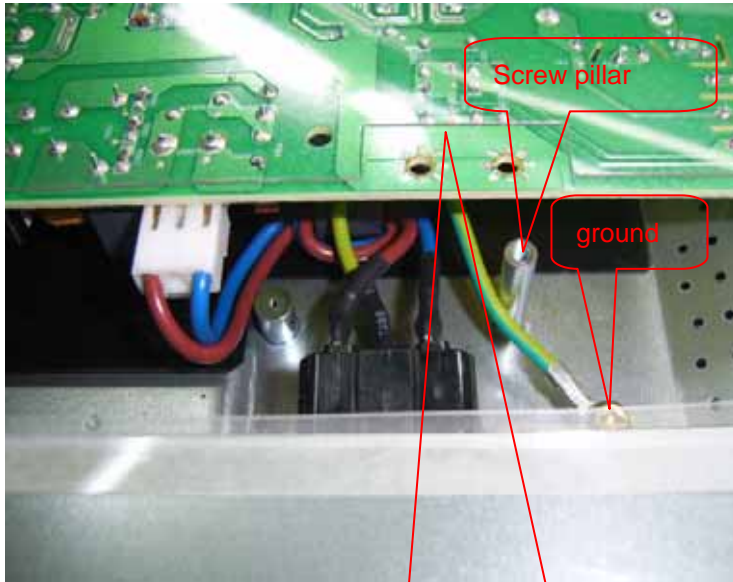

Screw AC ground line as the figure and should be laid at the left of screw pillar.

Note: The green line can't be pressed under the power board.

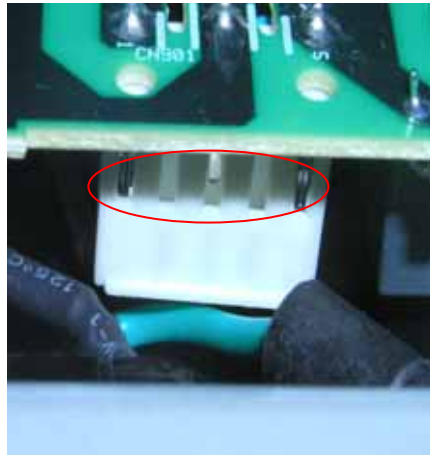

Note: The pins can't gore the blue and purple lines.



Affix black tapes for AU and SAMSUNG panel



Affix 50mm black tapes for SAMSUNG panel



The end

The angle between CCFL line and vertical direction should be 45 degree.

7. Schematic Diagram

7.1 Main Board

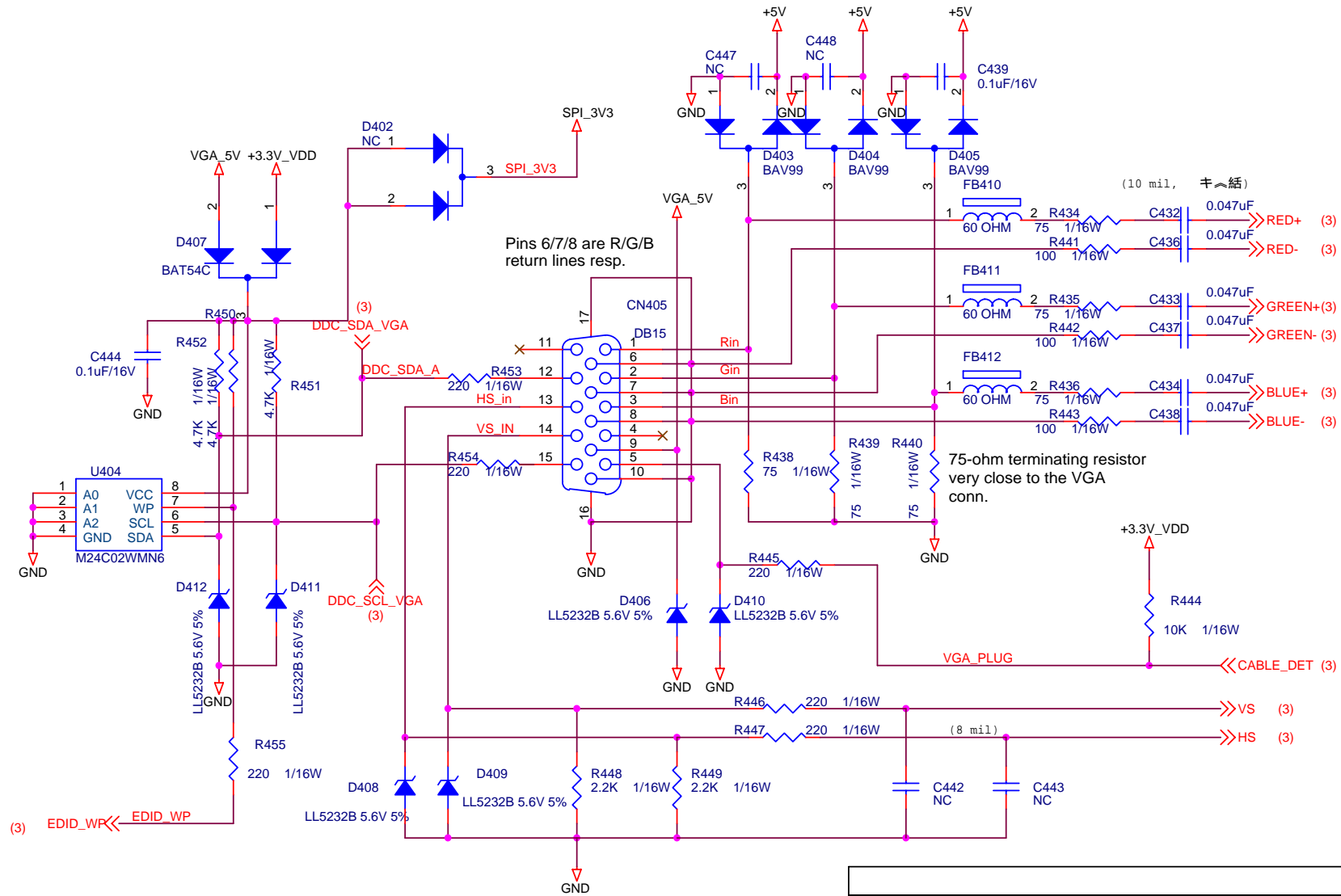

Title		
Input Connectors		
Size	Document Number	Rev
A		D
Date:	Wednesday, June 29, 2005	Sheet 2 of 6

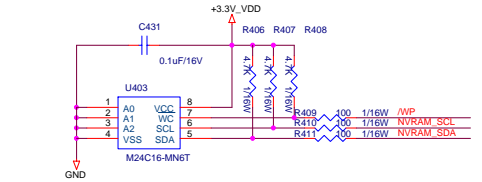
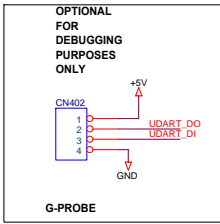
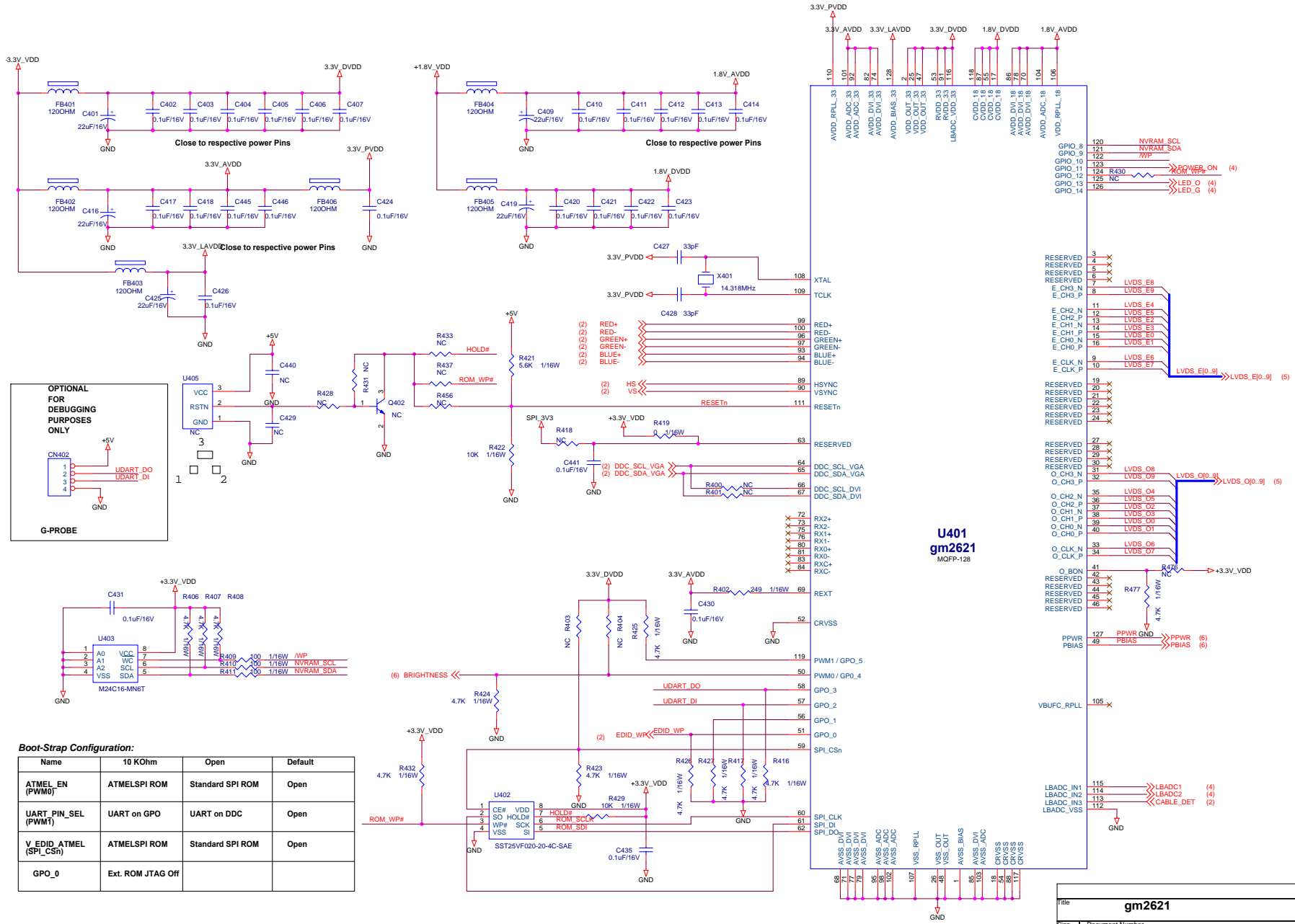

Boot-Strap Configuration:

Name	10 KOhm	Open	Default
ATMEL_EN (PWM0)	ATMELSPI ROM	Standard SPI ROM	Open
UART_PIN_SEL (PWM1)	UART on GPO	UART on DDC	Open
V_EDID_ATMEL (SPI_CS#)	ATMELSPI ROM	Standard SPI ROM	Open
GPO_0	Ext. ROM JTAG Off		

Title		gm2621	
Size	Document Number		
Custom			
Date:	Wednesday, June 29, 2005	Sheet	3 of 6
		Rev	D

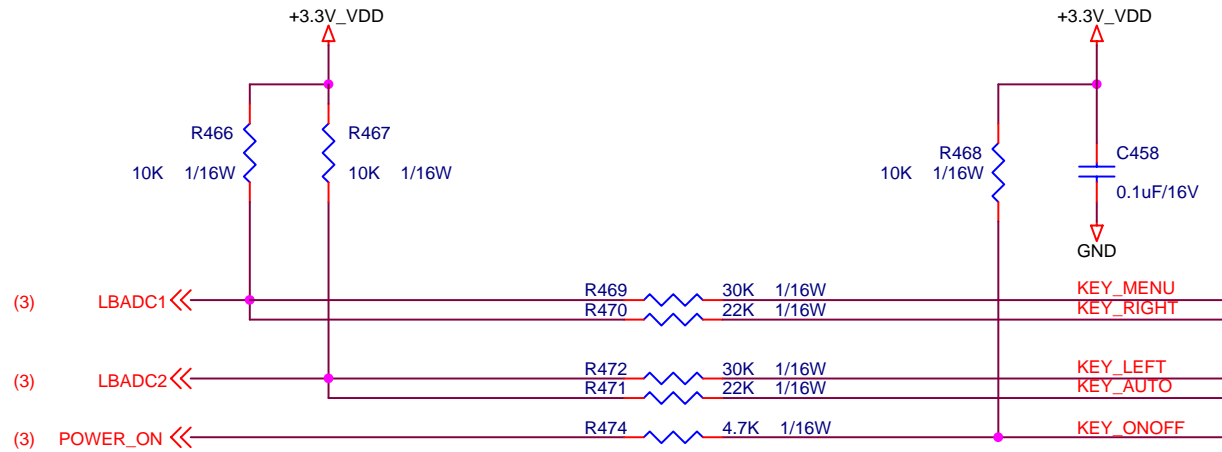
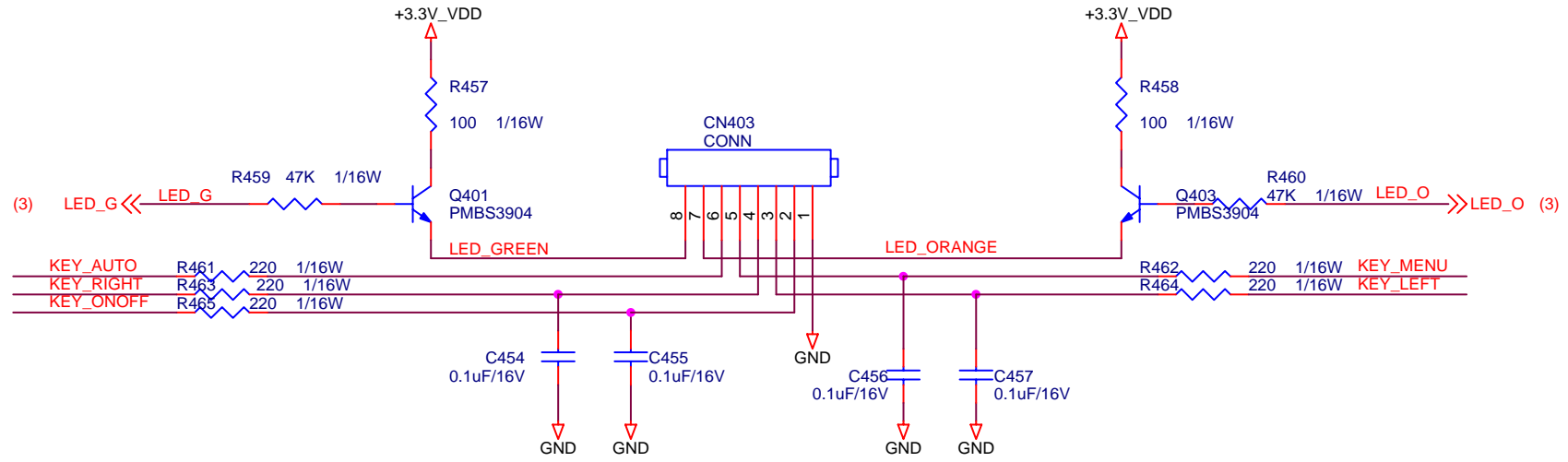

Title		
KEYPAD		
Size A	Document Number	Rev D
Date:	Wednesday, June 29, 2005	Sheet 4 of 6

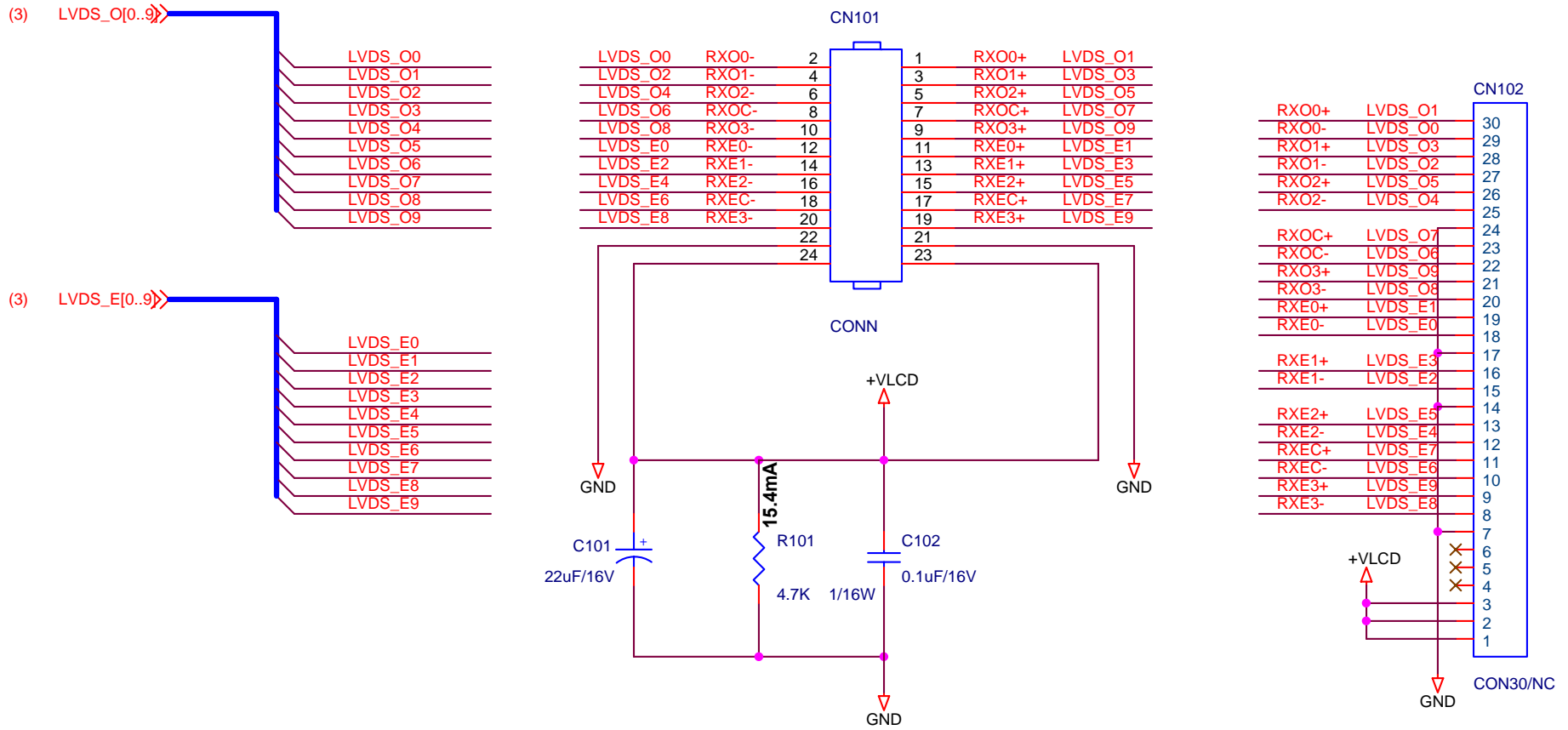

Title		
PANEL INTERFACE		
Size A	Document Number	Rev D
Date:	Wednesday, June 29, 2005	Sheet 5 of 6

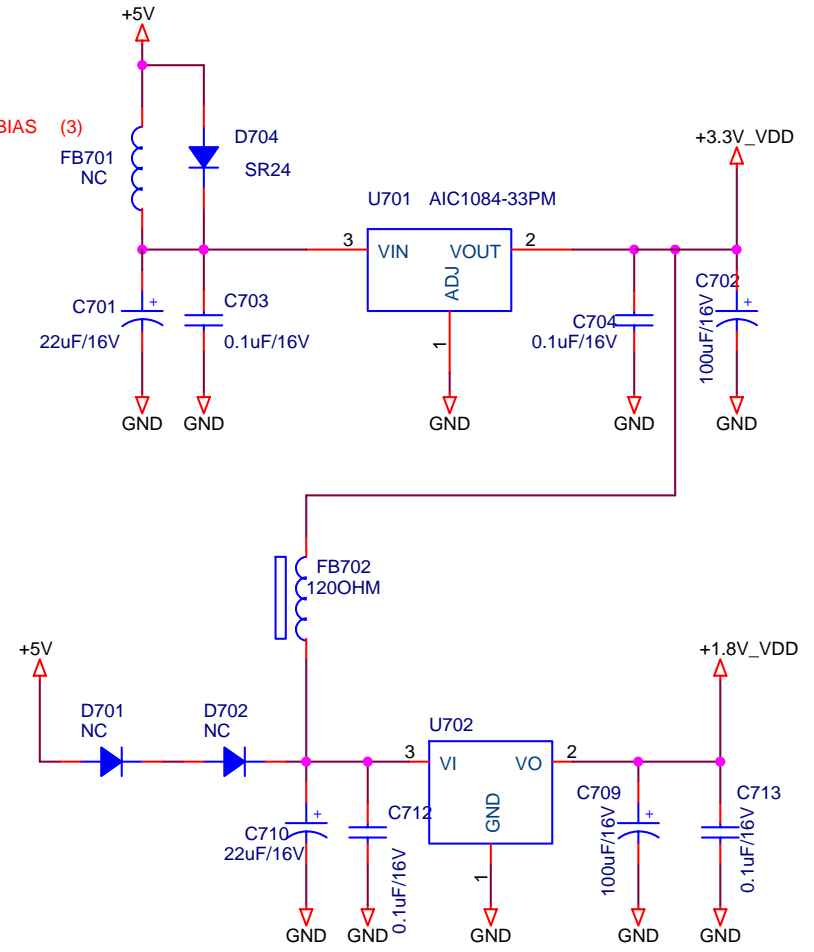
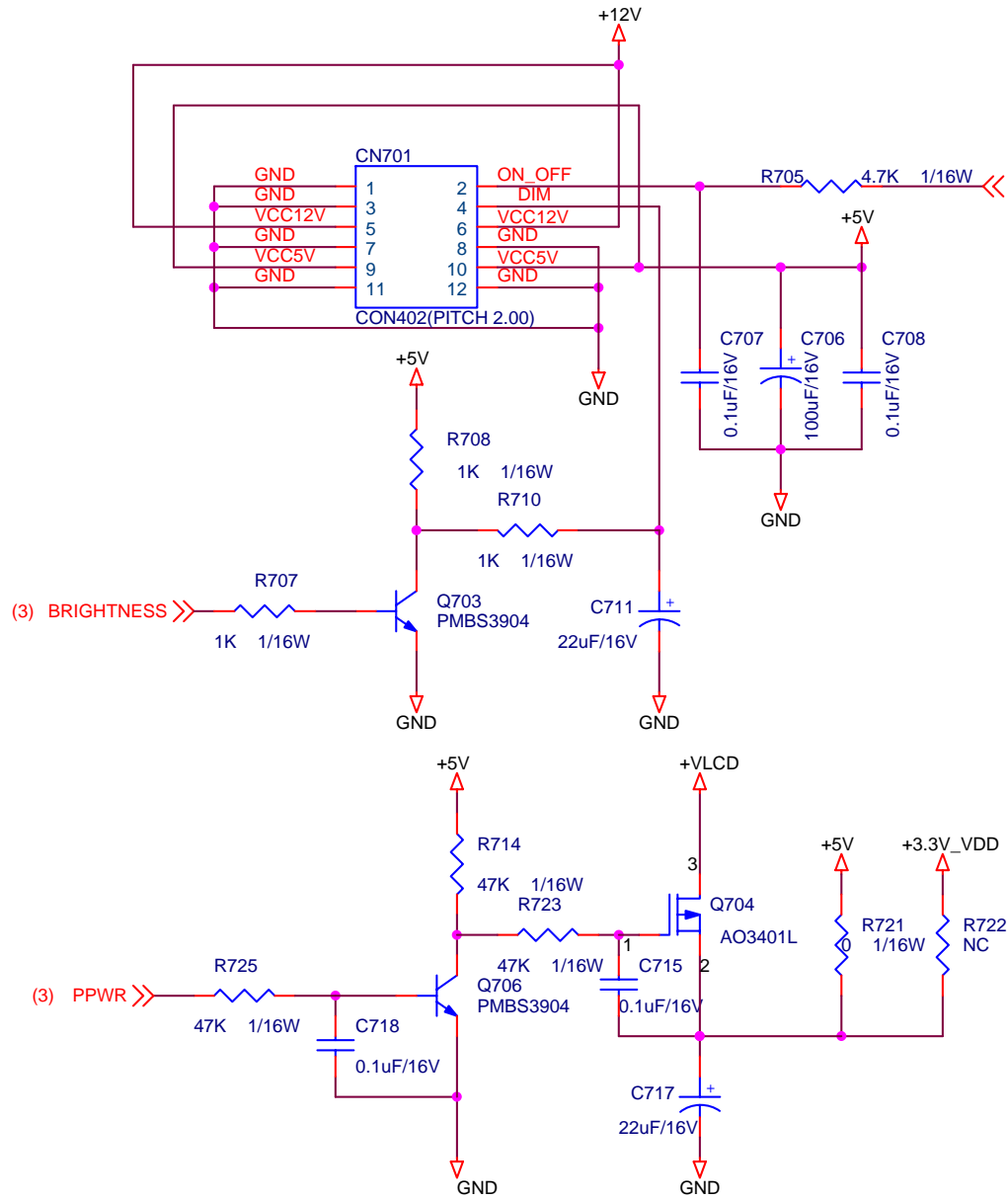

Title		
POWER		
Size A	Document Number	Rev D
Date:	Wednesday, June 29, 2005	Sheet 6 of 6

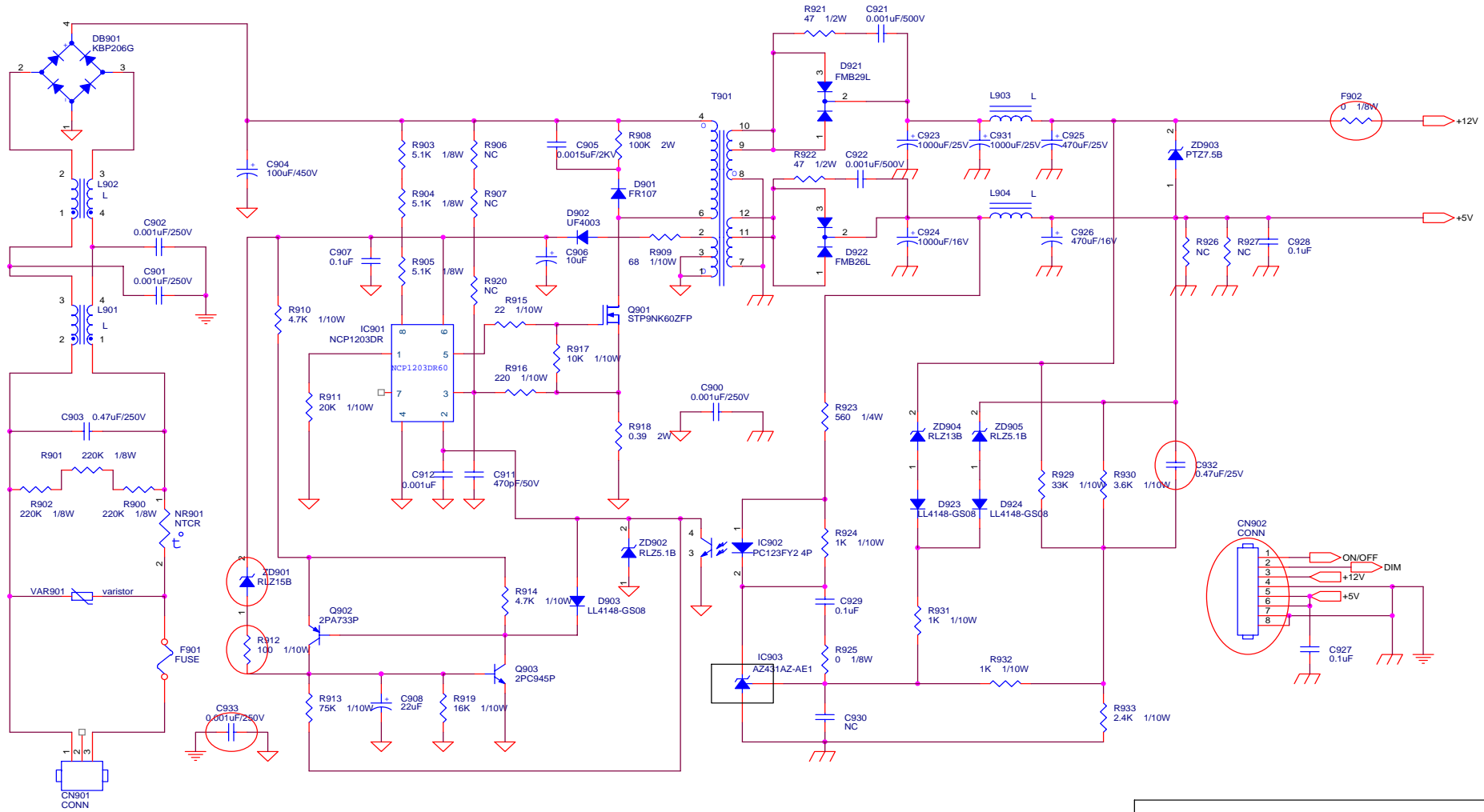

7.2 Power Board

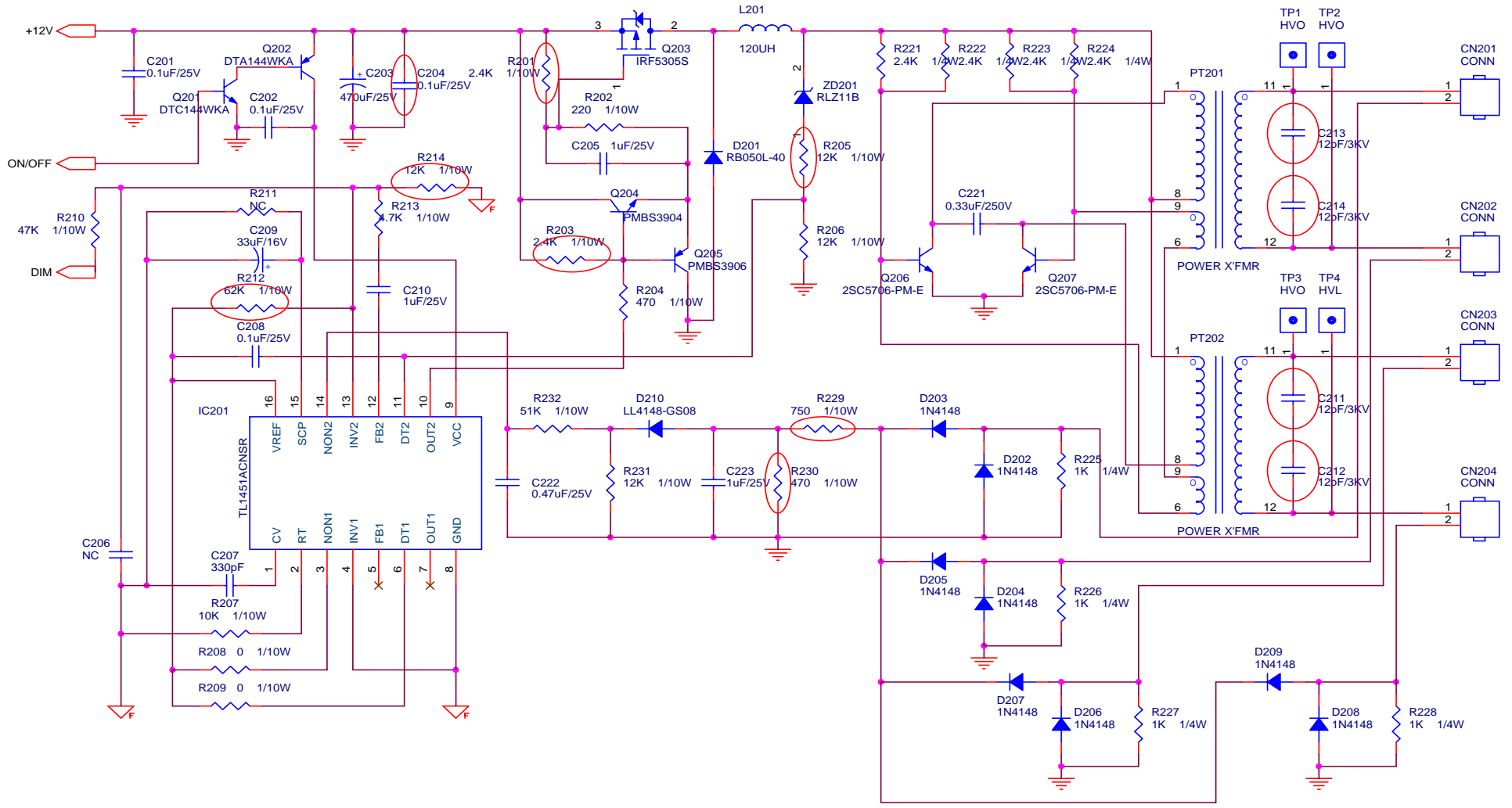

AOC (Top Victory) Electronics Co., Ltd.		
Title: 1.POWER OUTPUT 12V & 5 V		
Size B	Document Number: PWPC1742SE11 (715L1492-E)	Rev A
Date: Wednesday, March 09, 2005	Sheet 1	of 2



AOC (Top Victory) Electronics Co., Ltd.		
Title 2. FOR 17" 4 LAMPS INVERTER		
Size	Document Number PWPC1742SEI1(715L1492-E)	Rev A
Date: Wednesday, March 09, 2005	Sheet 2 of 2	

 is power GND
 is signal GND

8. PCB Layout

8.1 Main Board

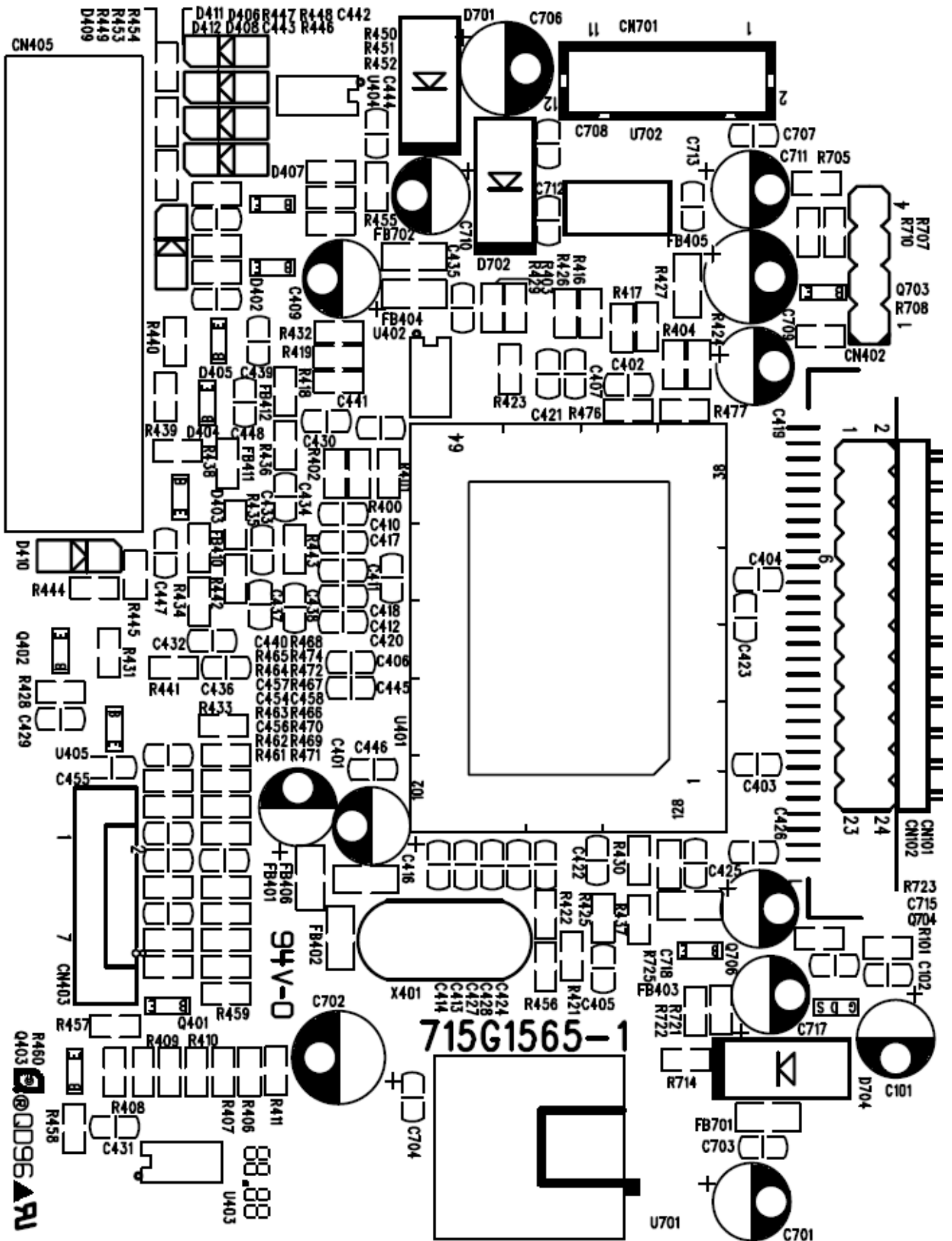

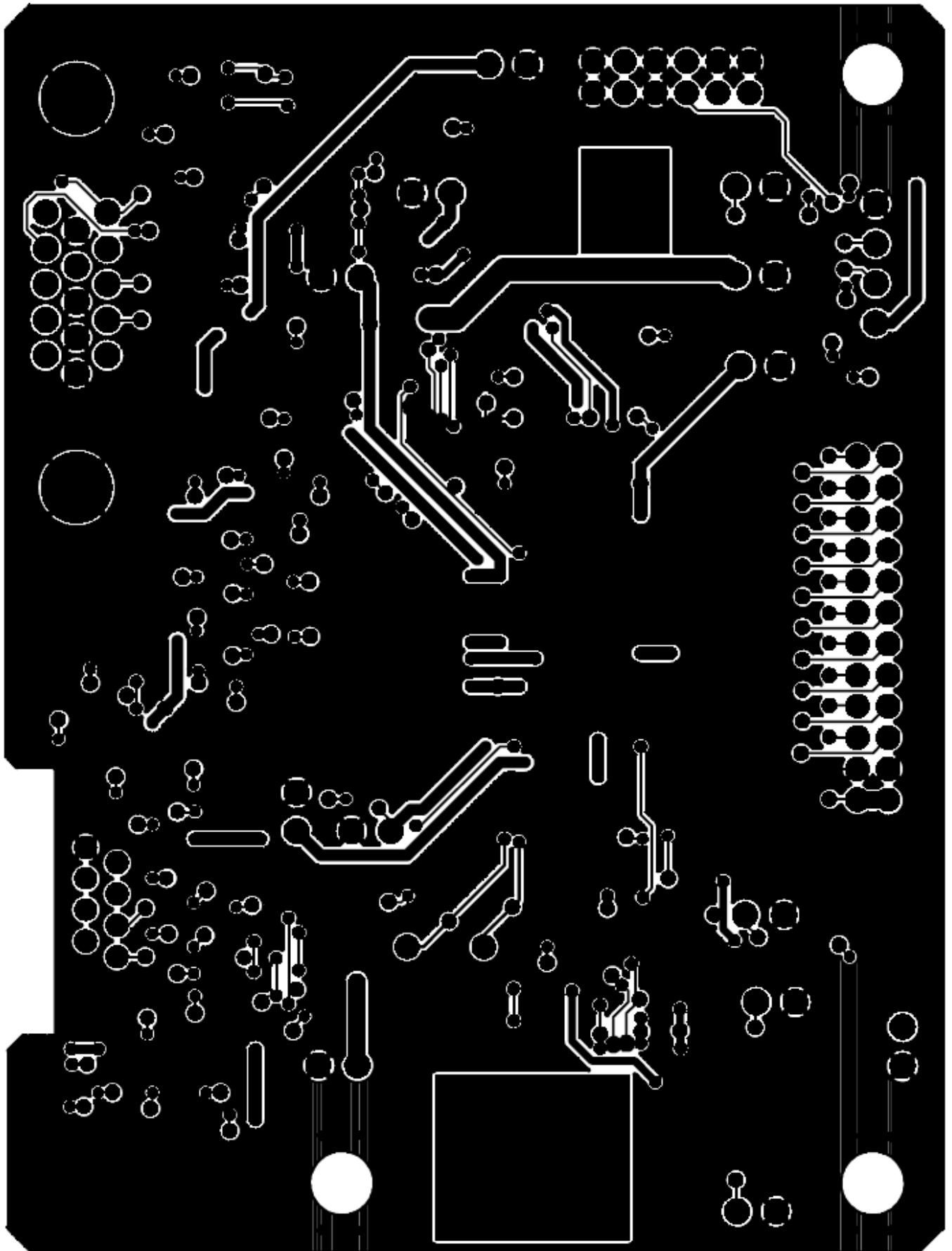

8.2 Inverter/Power Board

715G1492-1-FR

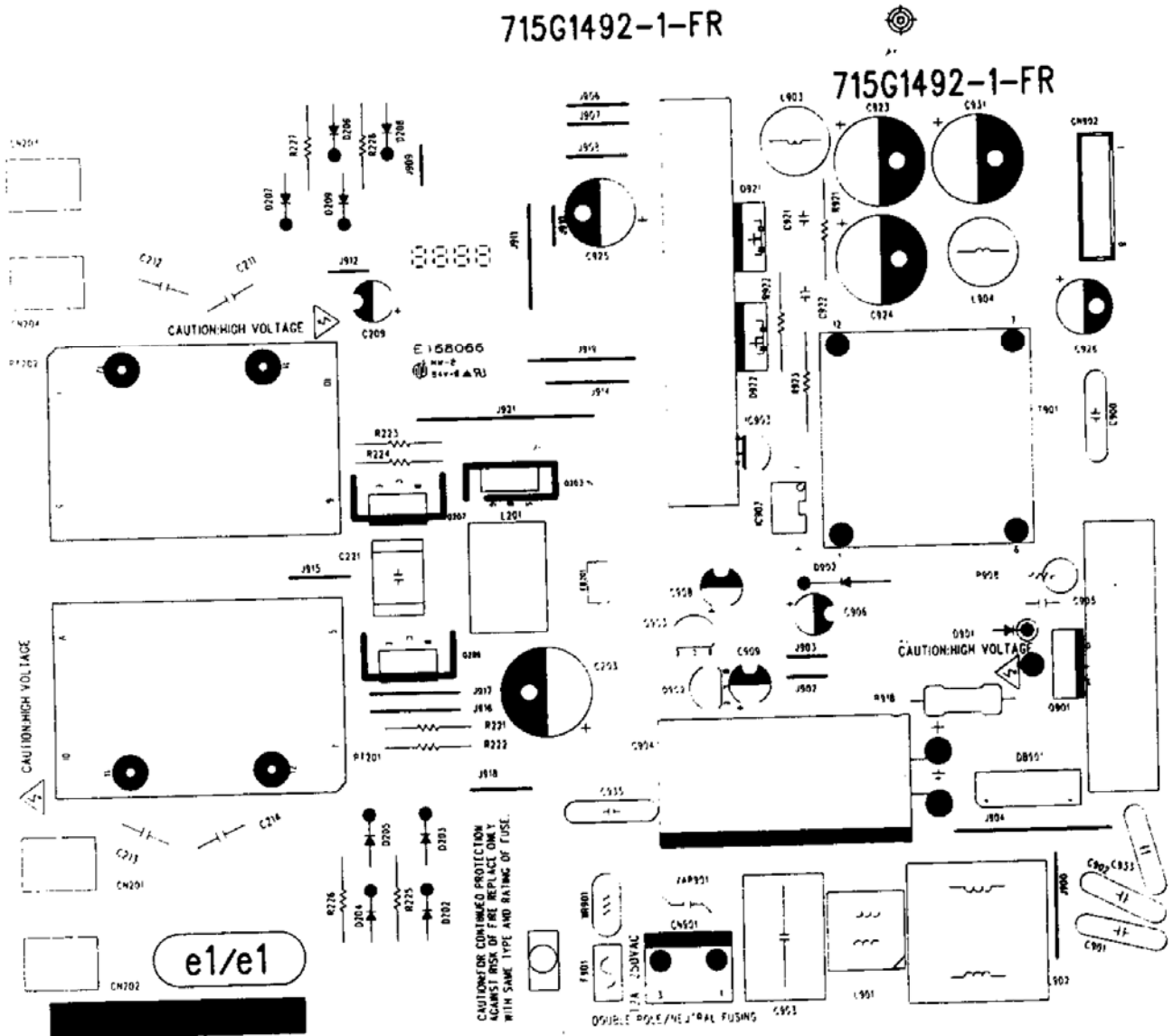

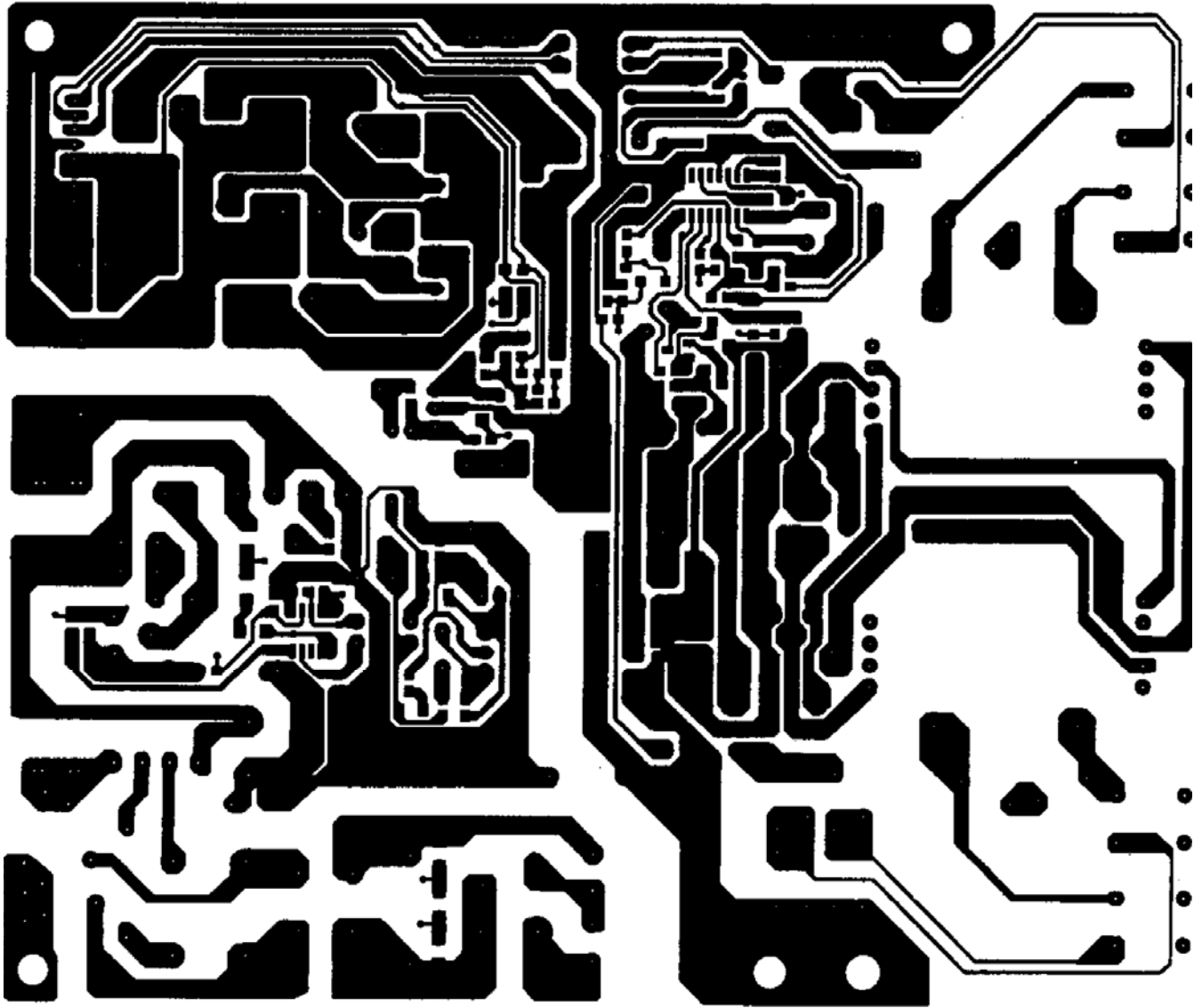

8.3 Key Board



9. Maintainability

9.1 Equipments and Tools Requirement

1. Voltage meter
2. Oscilloscope
3. Pattern Generator
4. LCD Color Analyzer
5. Service Manual
6. User Manual

9.2 Trouble shooting

9.2.1 Main Board

No display

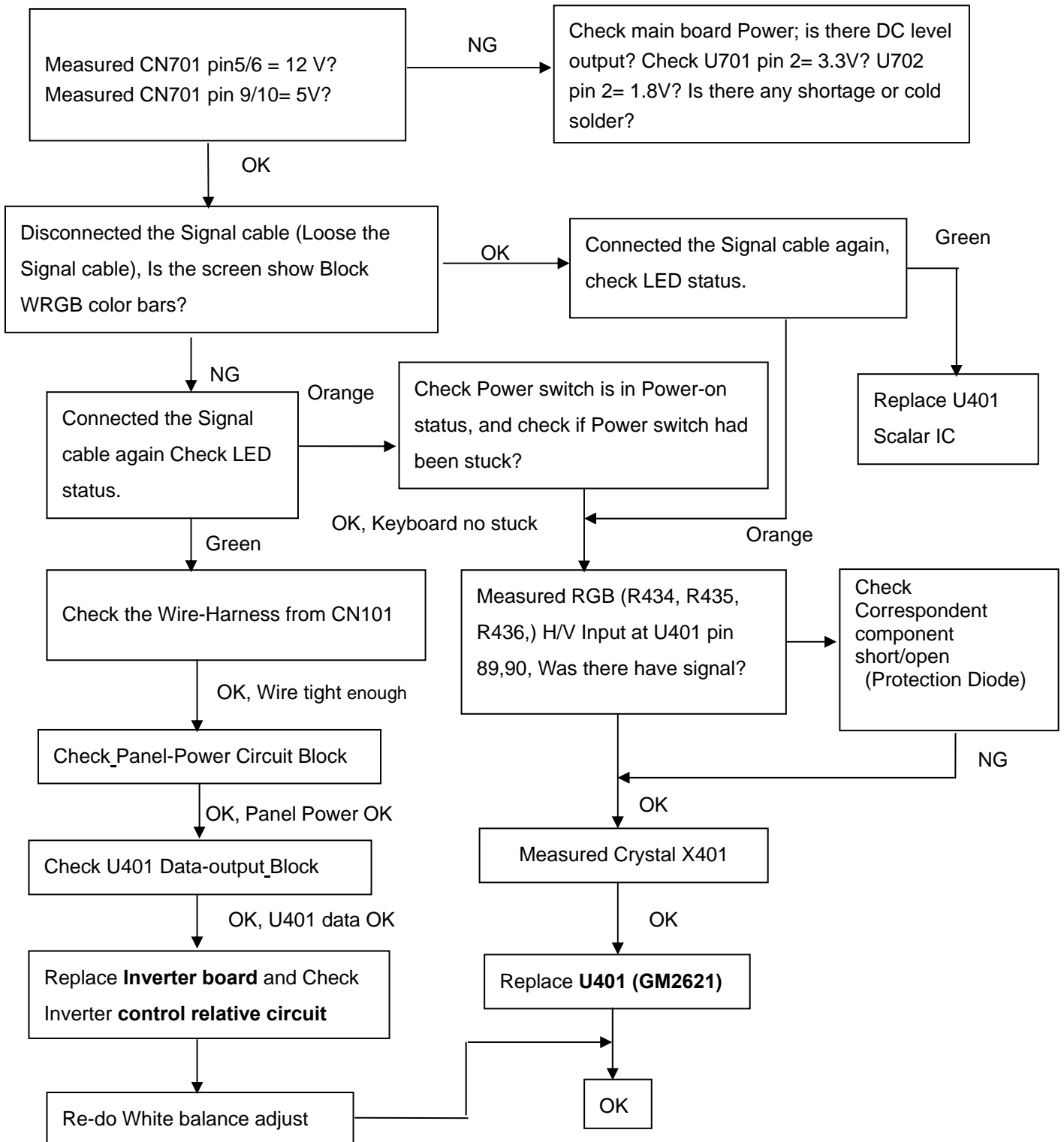

Note: 1. If replace “**Main-Board**”, Please re-do “DDC-content” programmed & “White-Balance”.

2. If replace “**Power Board**” only, Please re-do “White-Balance”.

Panel Power Circuit

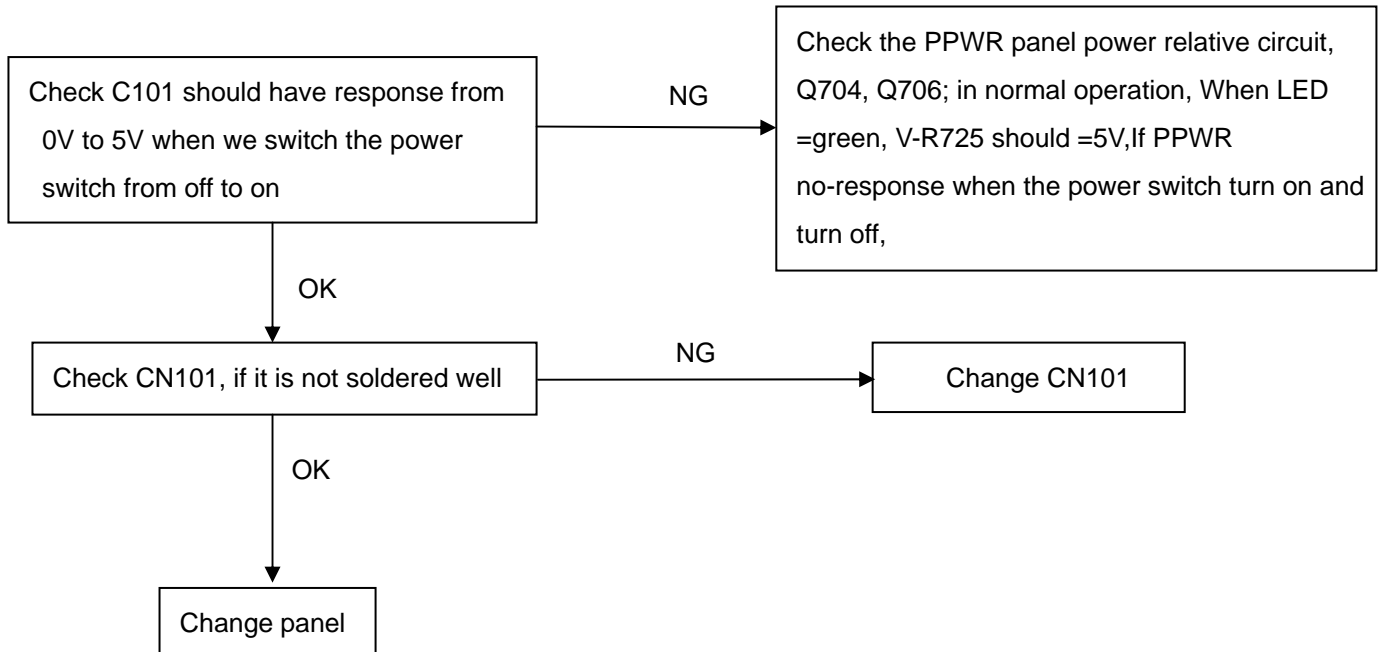

Inverter Control Relative Circuit

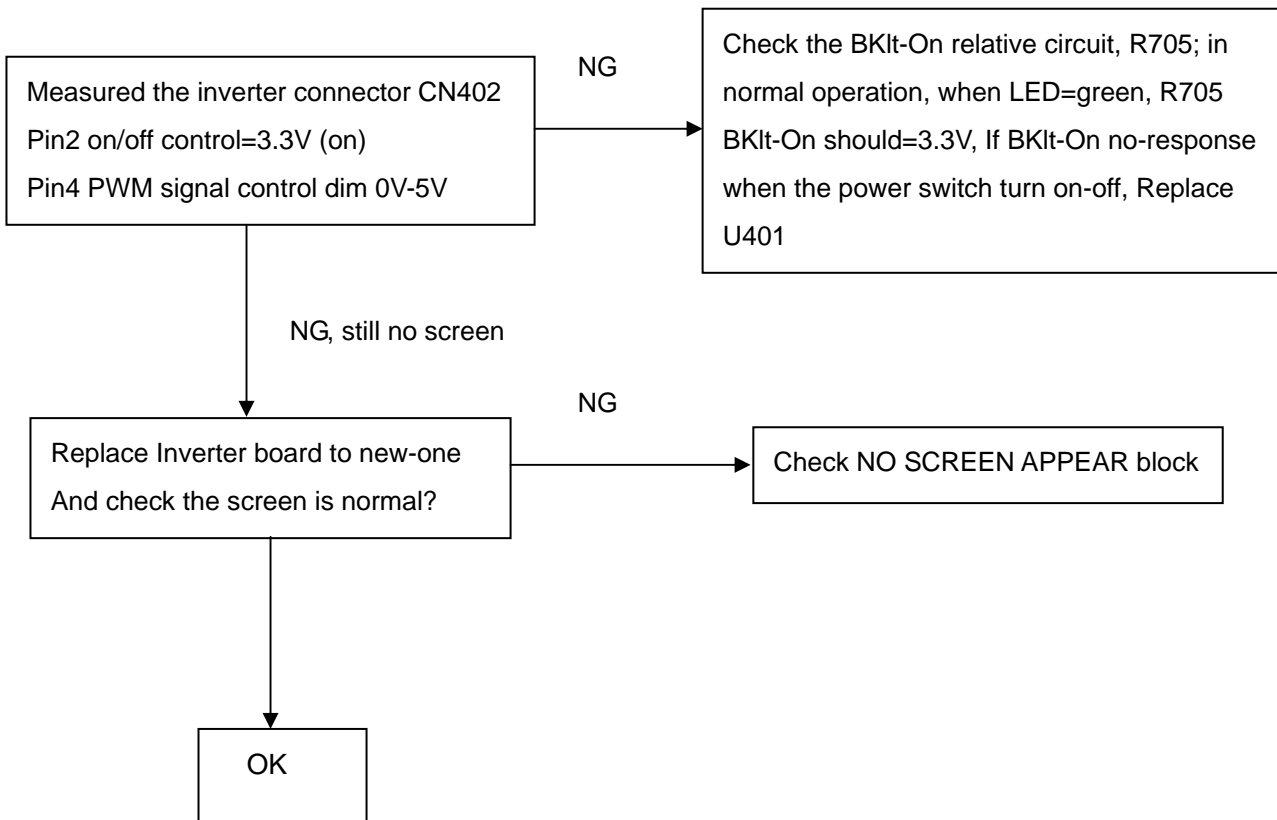

U401-data Output

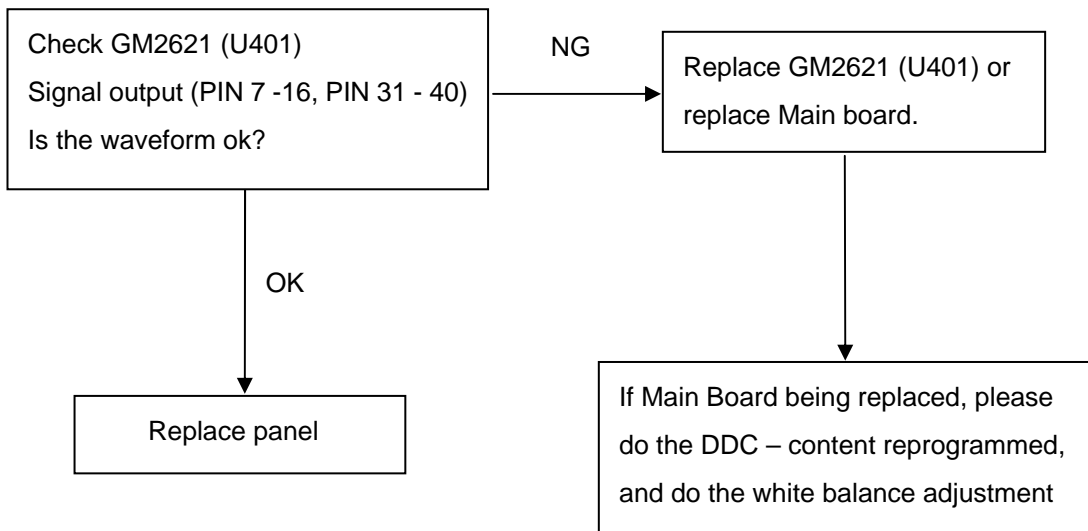

9.2.2 Inverter/Power Board

No Power

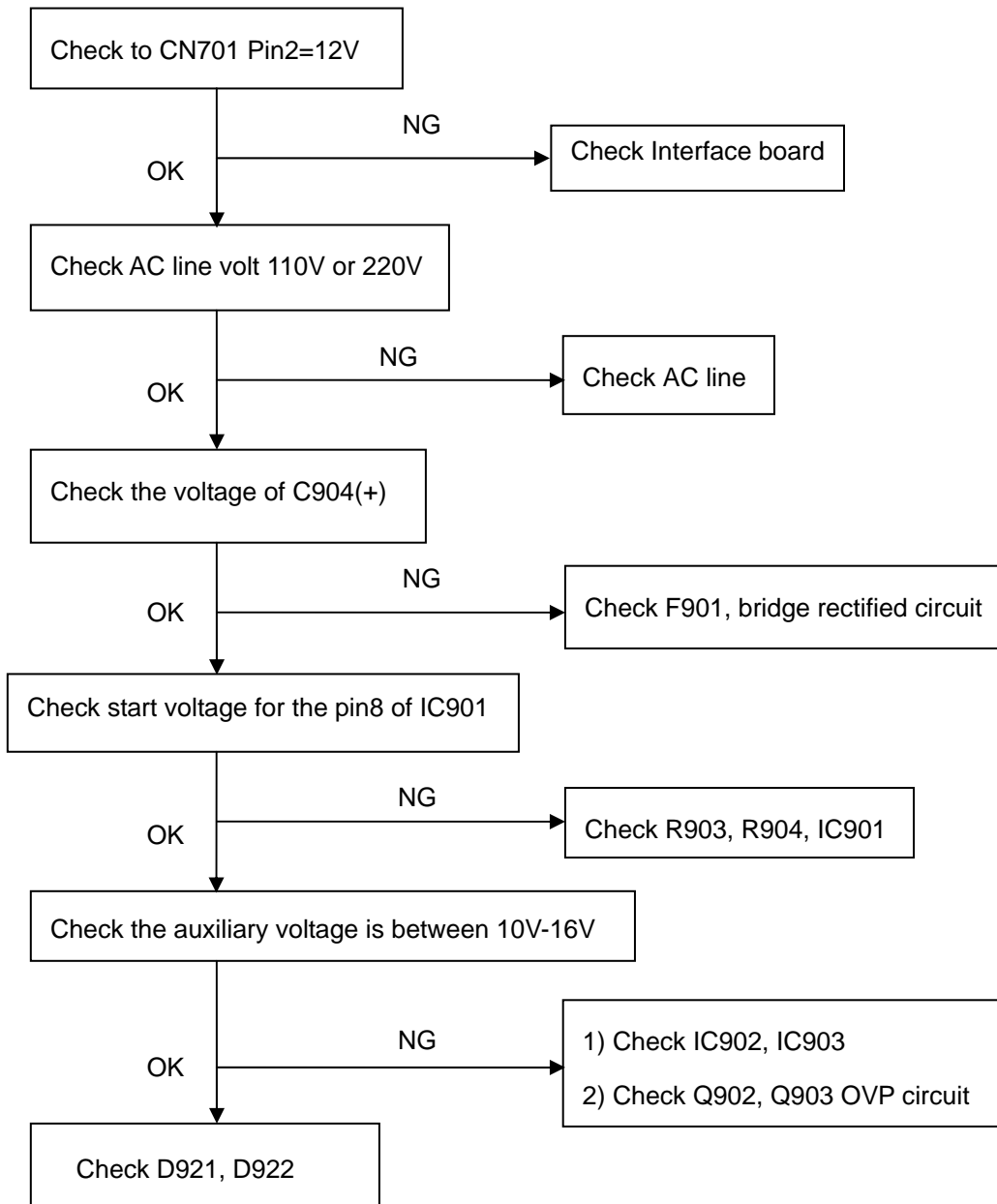

No Backlight

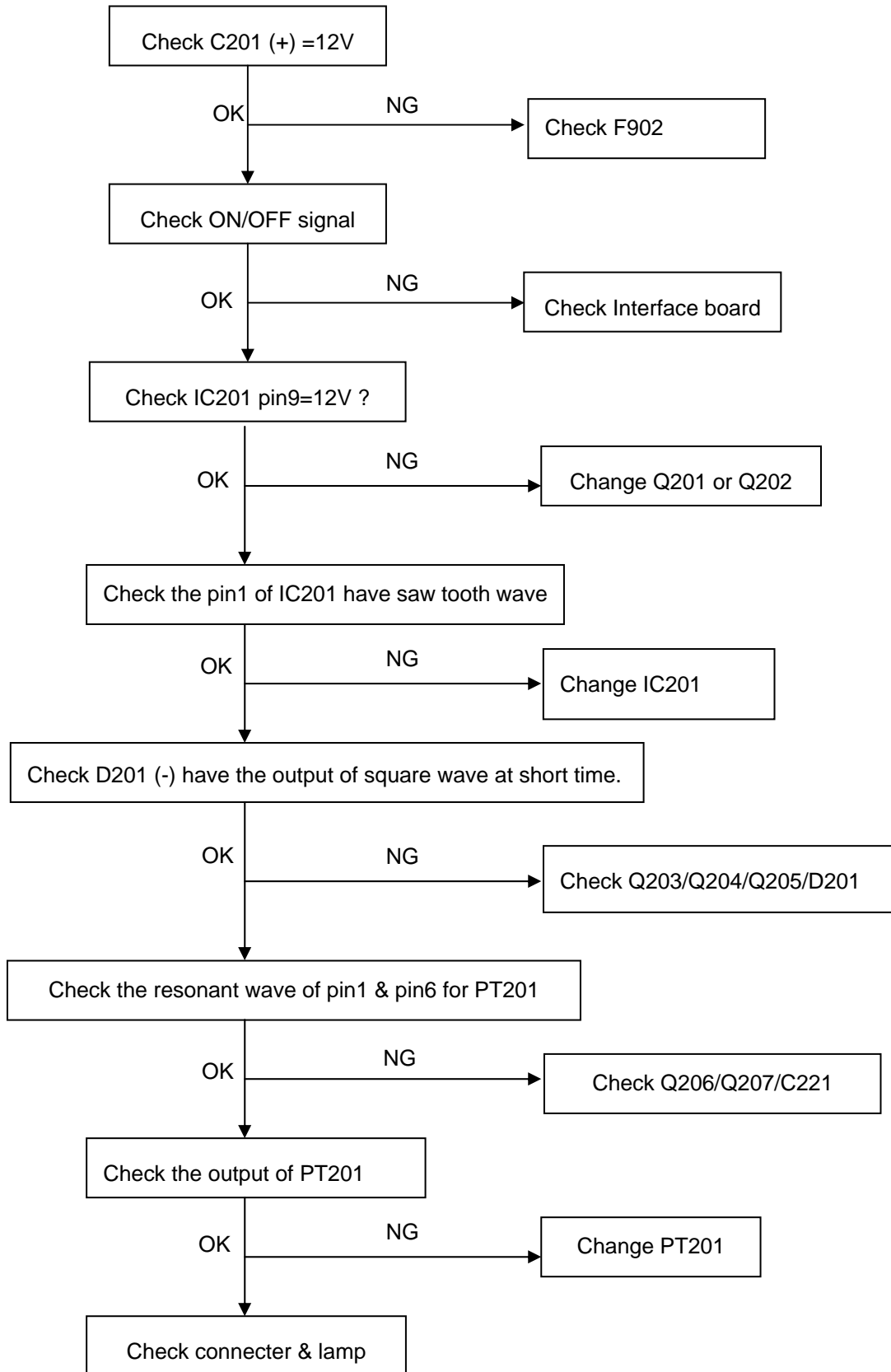

9.2.3 Key Board

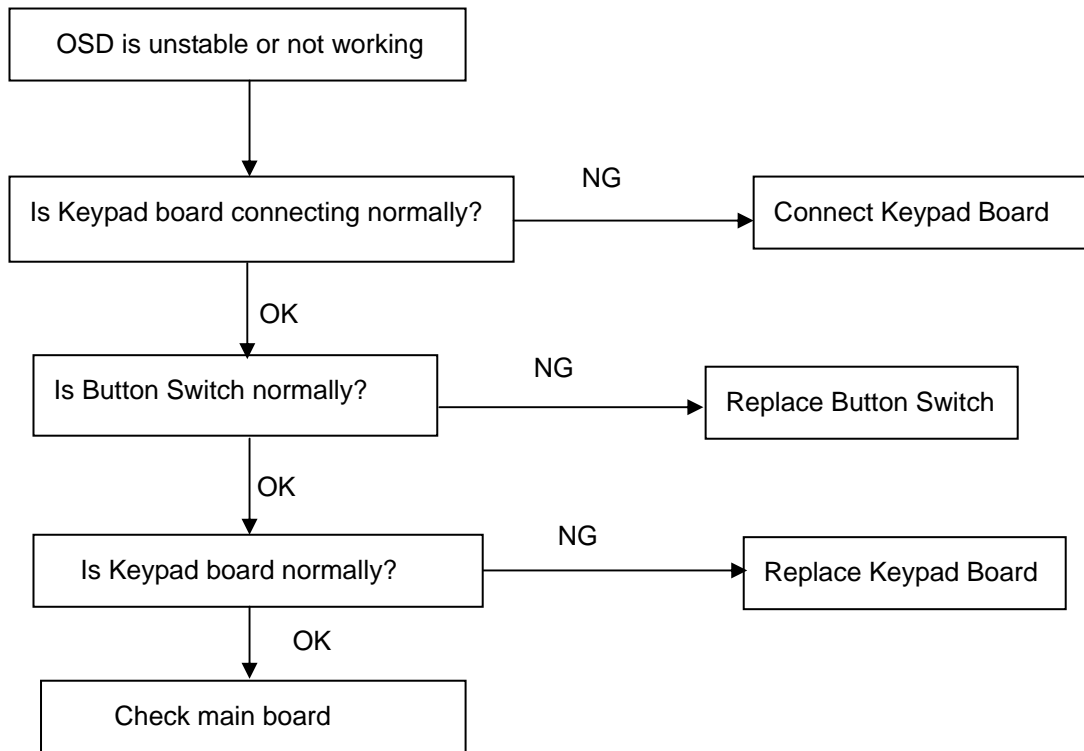

10. White balance, Luminance adjustment

Approximately 2 Hours should be allowed for warm up before proceeding White-Balance adjustment.

Before started adjust white balance, please setting the Chroma-7120 **MEM. Channel 3 to 6500⁰K** colors, **MEM. Channel 4 to 9300⁰K** colors, **MEM. Channel 9 to 5700⁰K** (our 9300 parameter is $x=283\pm28$, $y=297\pm28$, $Y = 175 \pm 20 \text{ cd/m}^2$, 6500 parameter is $x = 313\pm28$, $y=329\pm28$, $Y = 180 \pm 20 \text{ cd/m}^2$, and 5700 parameter is $x = 328 \pm 28$, $y = 344 \pm 28$, $Y = 180 \pm 20 \text{ cd/m}^2$)

How to setting MEM.channel you can reference to chroma 7120 user guide or simple use “**SC**” key and “**NEXT**” key to modify xyY value and use “**ID**” key to modify the TEXT description Following is the procedure to do white-balance adjust

Press MENU and AUTO-ADJUST button during press Power button will activate the factory mode,

Gain adjustment:

Move cursor to “-Factory Setting-” and press MENU key to enter this sub-menu.

Move cursor to “ Factory” and press MENU key.

Move cursor to “ Auto Level” and press MENU key to adjust Gain and Offset automatically;

a. Adjust sRGB (6500⁰K) color-temperature

1. Switch the chroma-7120 to **RGB-mode** (with press “MODE” button)
2. Switch the MEM.channel to Channel 3 (with up or down arrow on chroma 7120)
3. The LCD-indicator on chroma 7120 will show $x = 313 \pm 28$, $y = 329 \pm 28$, $Y = 180 \pm 20 \text{ cd/m}^2$
4. Adjust the RED on OSD window until chroma 7120 indicator reached the value $R=100$
5. Adjust the GREEN on OSD, until chroma 7120 indicator reached $G=100$
6. Adjust the BLUE on OSD, until chroma 7120 indicator reached $B=100$
7. Repeat above procedure (item 5,6,7) until chroma 7120 RGB value meet the tolerance $=100\pm 2$

b. Adjust **Color1** (9300⁰K) color-temperature

8. Switch the chroma-7120 to **RGB-mode** (with press “MODE” button)
9. Switch the MEM.channel to Channel 4 (with up or down arrow on chroma 7120)
10. The LCD-indicator on chroma 7120 will show $x = 283 \pm 28$, $y = 297 \pm 28$, $Y = 175 \pm 20 \text{ cd/m}^2$
11. Adjust the RED on OSD window until chroma 7120 indicator reached the value $R=100$
12. Adjust the GREEN on OSD, until chroma 7120 indicator reached $G=100$
13. Adjust the BLUE on OSD, until chroma 7120 indicator reached $B=100$
14. Repeat above procedure (item 5,6,7) until chroma 7120 RGB value meet the tolerance $=100\pm 2$

c. Adjust **Color2** (5700⁰K) color-temperature

15. Switch the chroma-7120 to **RGB-mode** (with press “MODE” button)
16. Switch the MEM.channel to Channel 9 (with up or down arrow on chroma 7120)
17. The LCD-indicator on chroma 7120 will show $x = 328 \pm 28$, $y = 344 \pm 28$, $Y = 180 \pm 20 \text{ cd/m}^2$
18. Adjust the RED on OSD window until chroma 7120 indicator reached the value $R=100$
19. Adjust the GREEN on OSD, until chroma 7120 indicator reached $G=100$
20. Adjust the BLUE on OSD, until chroma 7120 indicator reached $B=100$

21. Repeat above procedure (item 5,6,7) until chroma 7120 RGB value meet the tolerance =100±2

22. Move cursor to “ Exit/Save” sub-menu and press MENU key to save adjust value and exit.

Turn the POWER-button off to on to quit from factory mode.

Max Brightness measurement:

- a. Switch to the full white pattern, in user mode main menu:
 - 1. Set <Color Settings> Red, Green, and Blue to the max.
 - 2. Set <Brightness> Brightness, Contrast to the max.
- b. The Minimum brightness is 200cd/m² ±20

11. EDID Content

	00	01	02	03	04	05	06	07	08	09	10	11	12	13	14	15
0:	00	FF	FF	FF	FF	FF	FF	00	10	AC	14	A0	30	39	37	38
16:	0D	0F	01	03	68	22	1B	78	EE	CA	F6	A3	57	47	9E	23
32:	11	4F	54	A5	4B	00	71	4F	81	80	01	01	01	01	01	01
48:	01	01	01	01	01	01	30	2A	00	98	51	00	2A	40	30	70
64:	13	00	52	0E	11	00	00	1E	00	00	00	FF	00	39	30	31
80:	32	33	35	34	36	38	37	39	30	0A	00	00	00	FC	00	44
96:	45	4C	4C	20	45	31	37	36	46	50	0A	20	00	00	00	FD
112:	00	38	4B	1F	50	0E	00	0A	20	20	20	20	20	20	00	4B

Note: Byte 0C, 0D, 0E, 0F means Serial No. Byte 10, 11 means manufacture time. Byte 7F means checksum

12. ISP (In System Program) User Manual

12.1 Connect ISP Writer preparation action

Connect RXD and TXD of PC to RXD (P3.0) and TXD (P3.1) of CPU through RS-232.

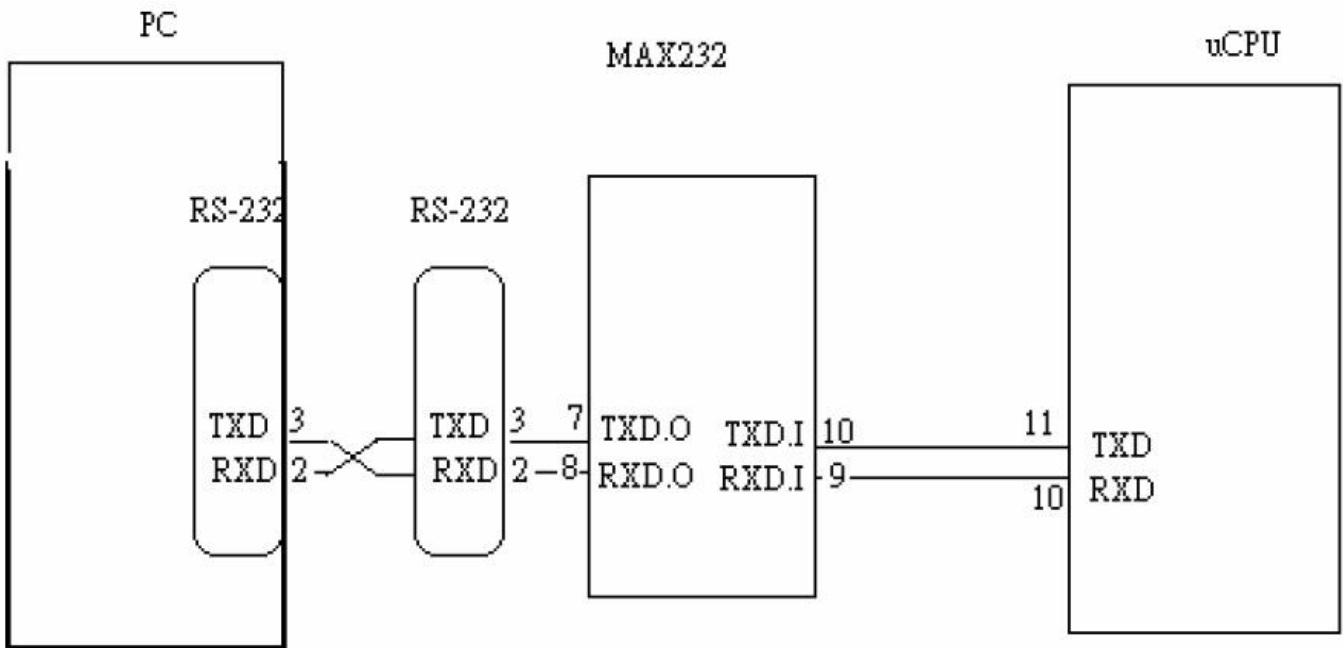

a. There are two ways to entering Reboot Mode. The settings for Reboot Mode is as follow

- Both P2.6 P2.7 are LOW and RESET pin is HIGHT.
- P4.3 is LOW and RESET pin is HIGHT.

12.2 To Use ISP WRITER (take E153FP for example)

Press the “-“ key at front bezel and plug the AC power cord in, then the MCU enter ISP mode;

a. You will enter the window as follow after executing the ispwriter.exe file.

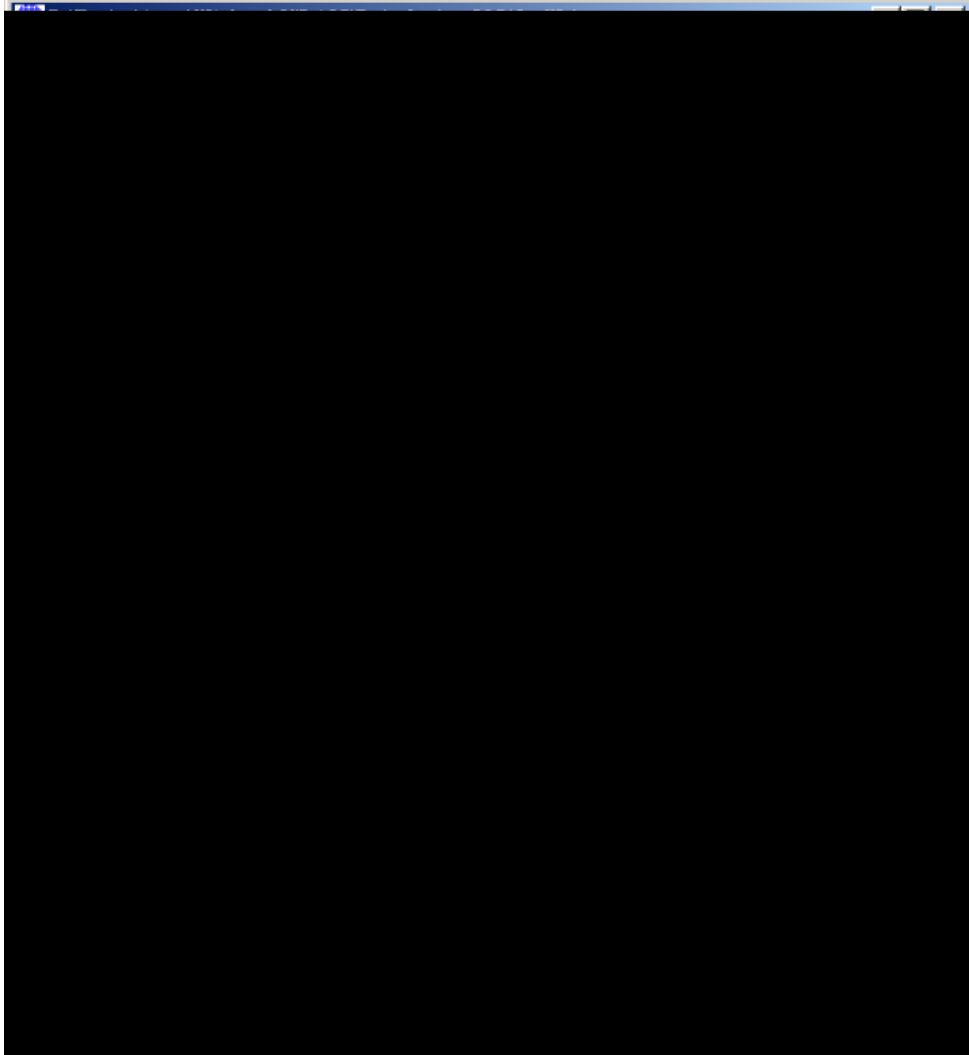

b. Click the “Select Chip” button, and choose the type you’re going to program.

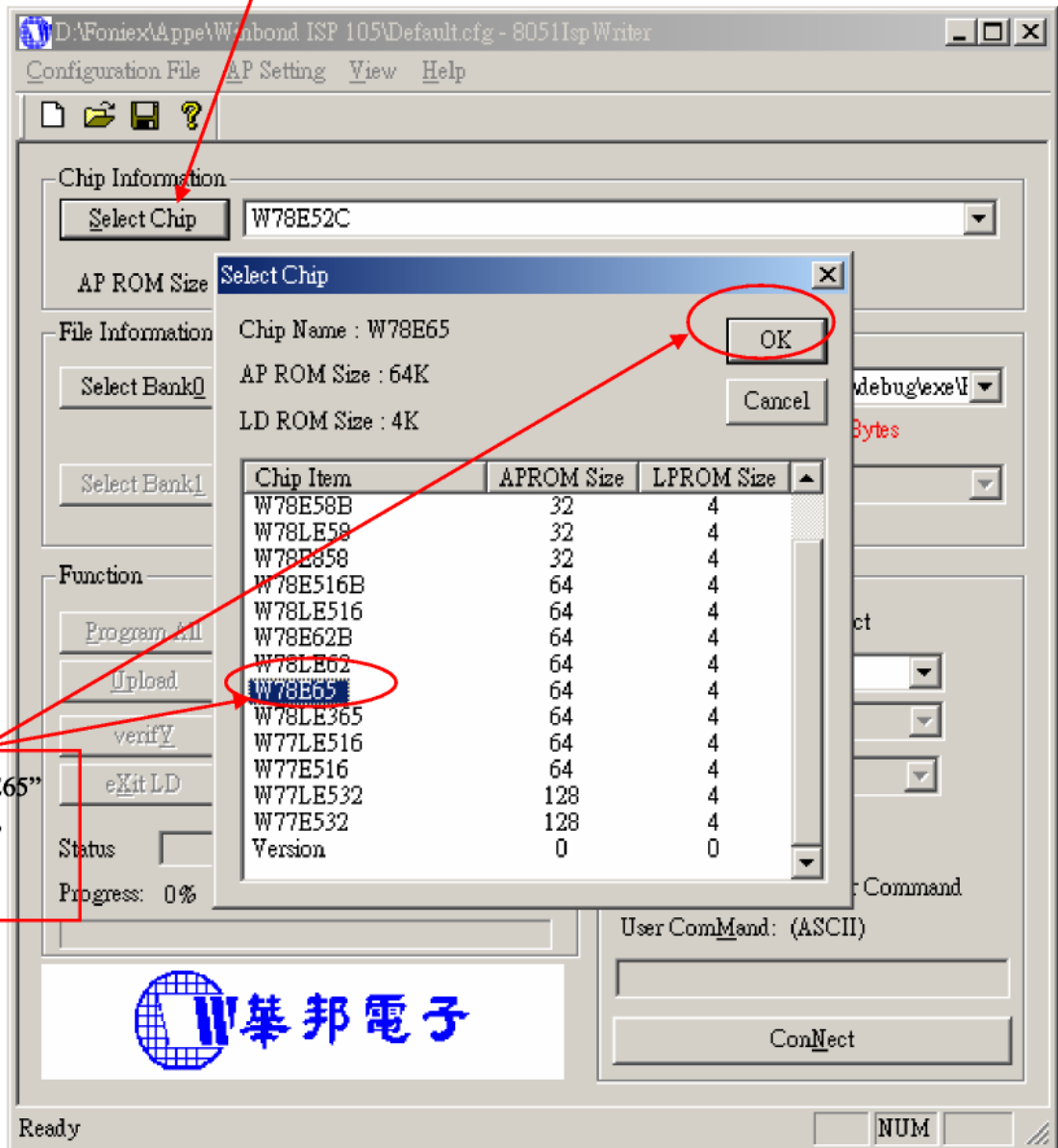

c. Click the "Select Bank0" button and selecting a file which a binary Format required.

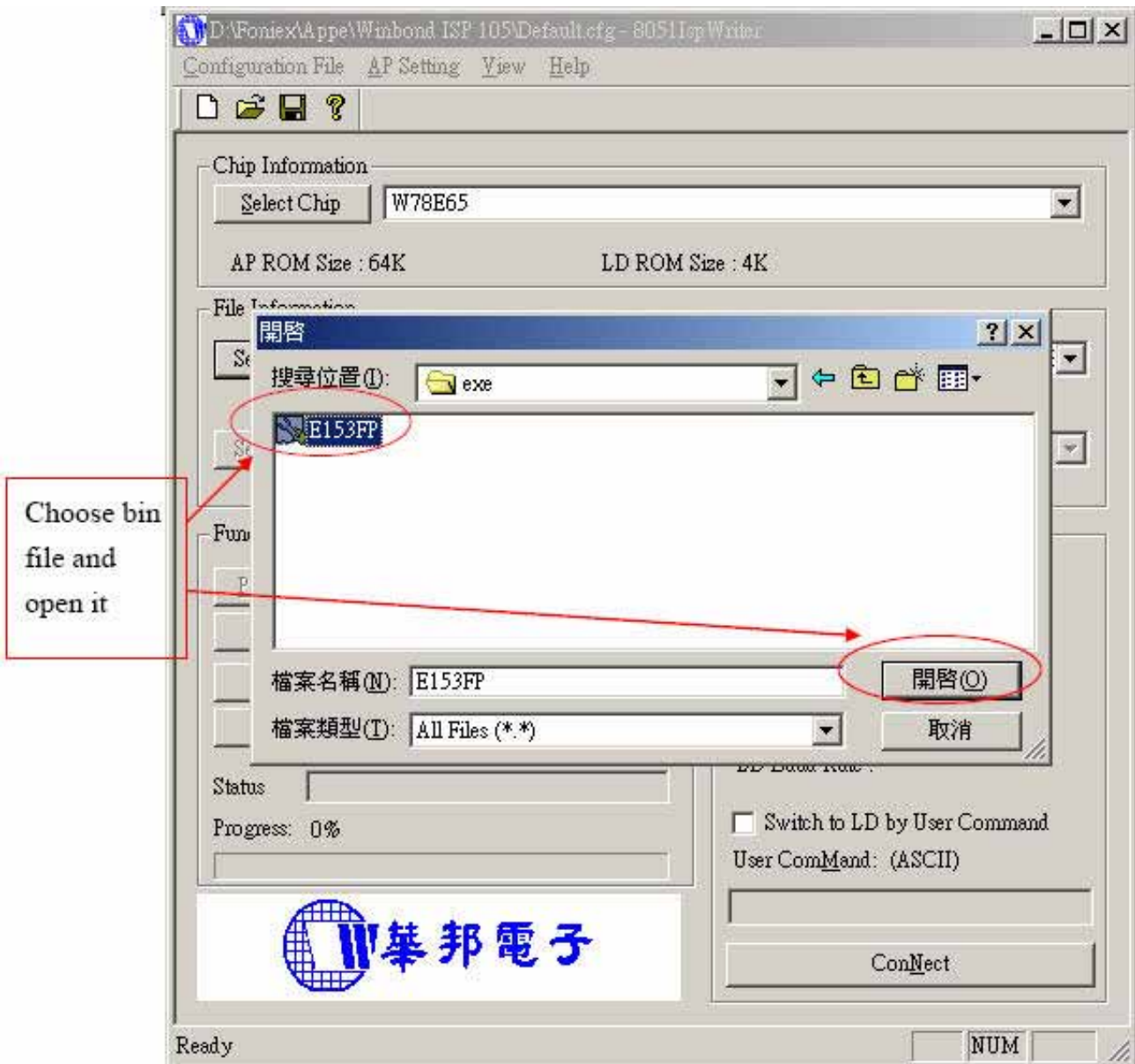

d. Select the communication Setting: Port Name

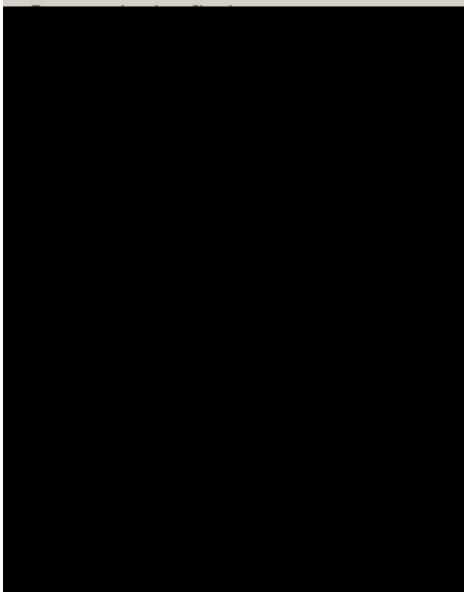

e. Click the “ConNect” button.

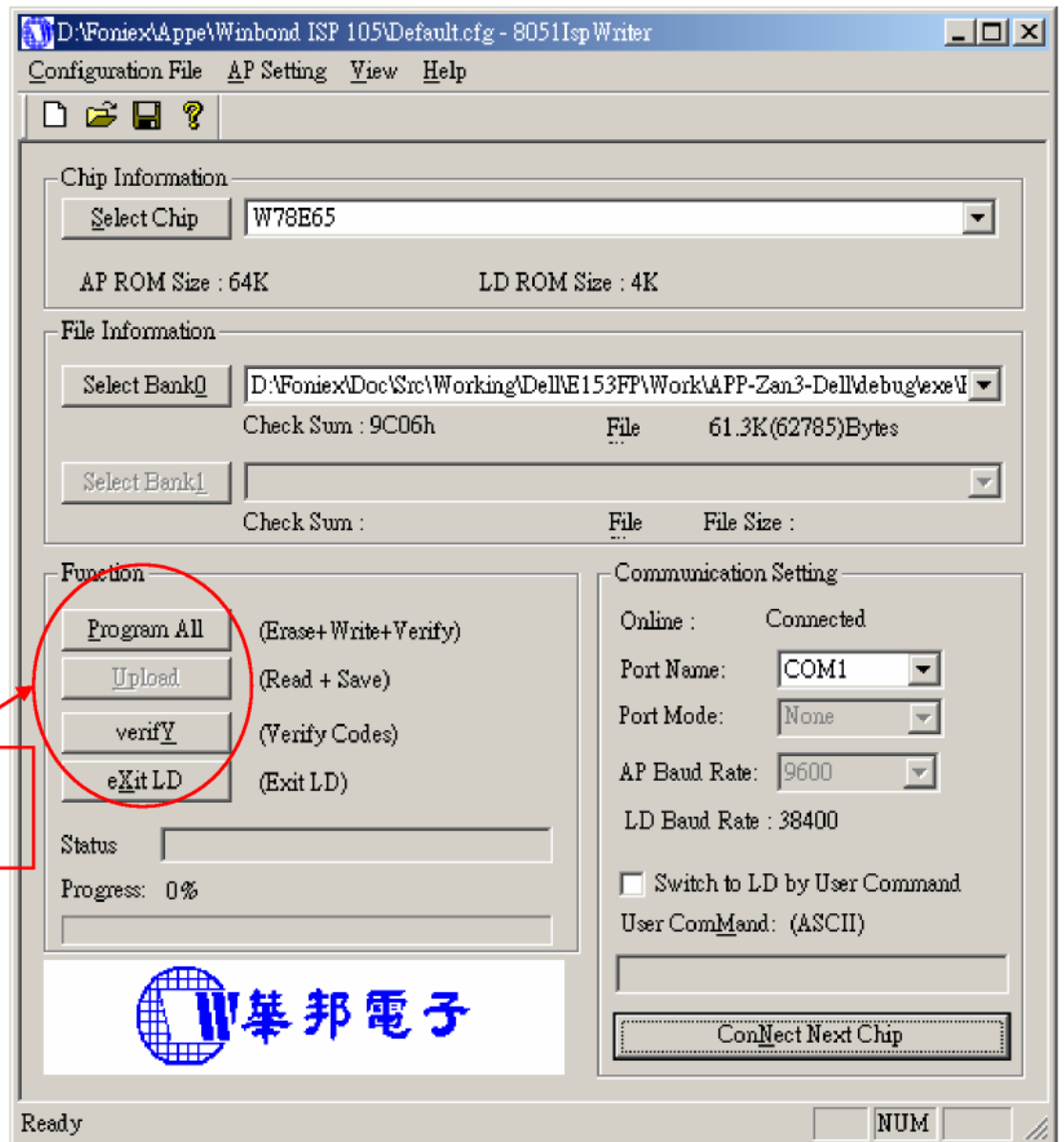

These buttons will be enable.

f. Click "Program all" to start programming.

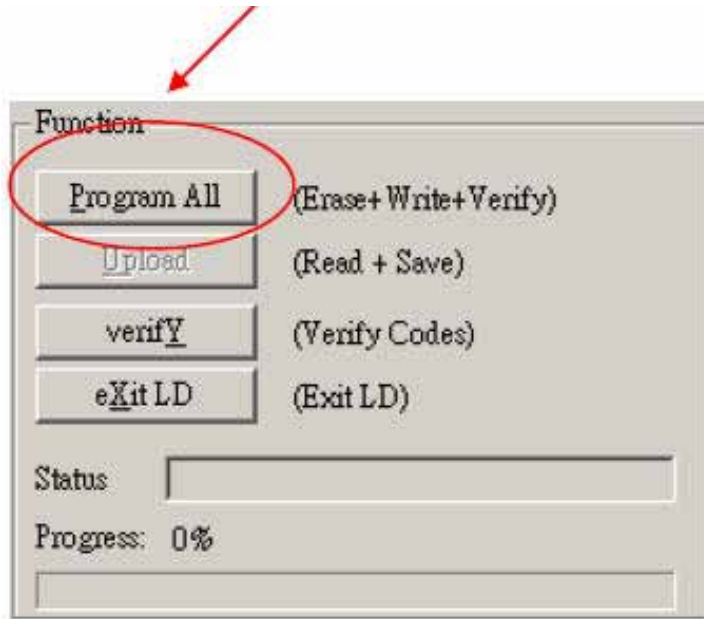

12.3. Executing ISP

a. "Program All" button that will execute erase and program and verify. Then you can get the window as follow, and click "OK" to complete ISP process.

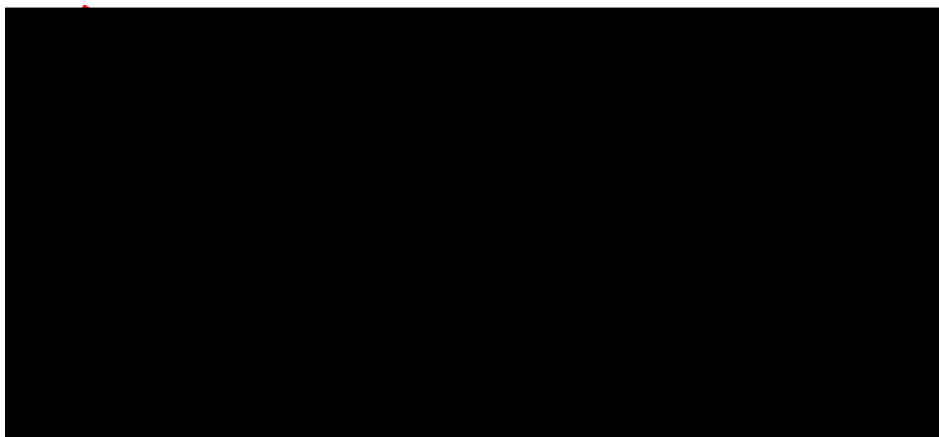

b. Complete the ISP process, click " exit LD " button to reset monitor.

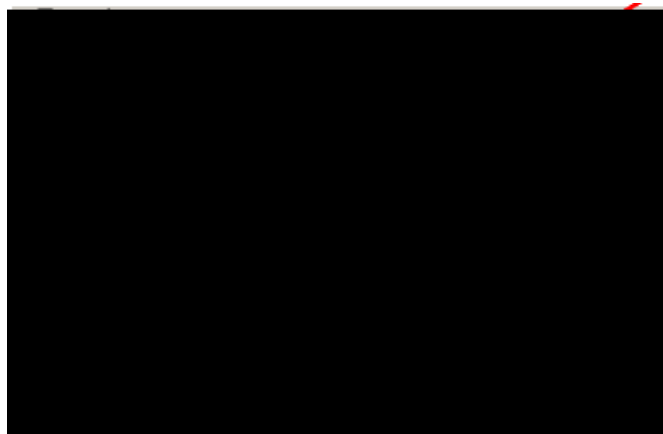

13. Check List

- 1) After replacing LCD Main board and panel, Check if white-balance is within the specs, then re-writing DDC is necessary.

The white-balance value for each common color temperature:

9300 parameter is $x=283\pm 28$, $y=297\pm 28$, $Y = 180 \pm 10 \text{ cd/m}^2$,

6500 parameter is $x = 313\pm 28$, $y=329\pm 28$, $Y = 180 \pm 10 \text{ cd/m}^2$,

5700 parameter is $x = 328 \pm 28$, $y = 344 \pm 28$, $Y = 180 \pm 10 \text{ cd/m}^2$

The color temperature value above must be up to the situation of $x < y$. The value of Y should be confirmed according to different customers. 15" LCD is commonly $180\pm 20 \text{ cd/cm}^2$ (Center) and 17" LCD is required to be larger than 200 cd/cm^2 (Center). The exact brightness values are confirmed by the checking-regulations of different customers and different models.

2) Steps of white-balance adjustment for LCD:(Take 17" AOC LCD LM724 for example)

1. Required instruments: Chroma7120、 Chroma2325 (BGA265A)
2. First connect the instruments together and turn on the LCD power, then warm up for 30 minutes under full white screen mode. First press the "Reset" key in the menu to recover factory set as following.

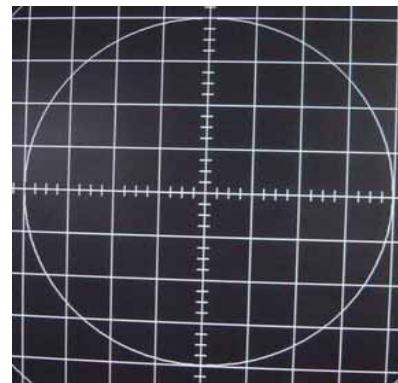

Set Chroma2325 at round-windows mode and make the detecting-head of Chroma7120 aim at the cross in the middle, the distance between the detecting-head and the cross is 20cm.

3. Set Chroma2325 (BGA265A) to be T144 (1280*1024/60HZ) and P105 of full white screen. Test if the white-balance value is within the specs. Please follow the steps below to adjust if it is beyond the specs.
4. Cut the power. Then press MENU key and re-plug power cable at the same time to enter into the factory mode. See the following pictures.



Select "F", then Select
AUTO LEVEL item.



5. Test white-balance again after Auto Level. Adjustment with hand is necessary if it is beyond the specs.
6. Select 7x00 item to adjust cool color-temperature and select 6x00 to adjust warm color- temperature. It can reach to the best effect through adjusting R/G/B value if it inclines to green or blue.

7. Select Exit to the upper menu after completing the adjustment. Then press POWER OFF to exit and save it.

3) Steps for writing DDC :

1. Employ PC, and connect the DDC-writing instrument and the instrument that is ready for writing into DDC to the power of 12V. Connect the signal cable of the latter to D-USB or DVI of DDC-writing instrument (The data-writing of monitor needs transfer-interface) and link the DDC-writing instrument with PC through printer interface. (See the schematic picture below)



(Connection for VGA)



(Connection for DVI)

2. Seek the document with the expanded name of **.BAT** in DDC file of this model. It appears the indication of " Input Serial No. : " after dual-click the document to be ready for DDC-writing.
3. Input the serial number of the product (For instance: AOC LM725 is 13 bits), and then press ENTER to start writing
4. Check the indication of DDC-writing program at the end. When you see the picture as the schematic picture above, the " Data compare OK!" Means being written well and that's the end. Please check if the Manufacturer Name, Vendor Assigned Code, Monitor Name, Serial Number, Week of Manufacture, Year of Manufacture are right. It will appear " Data compare error! " To indicate failure if the DDC-writing doesn't perform well. Please check the power resource and the connection of the signal cable, then return to step 3 by pressing ENTER and re-do it.
5. You can exit the program by pressing Ctrl plus C, and then cut the signal cable and the power.
6. The following picture is taking AOC LM725 EDID for example.

```

Manufacturer Name : ADC
Product Code      : A725
Model Name       : LN725

Week of Manufacture : 22
Year of Manufacture : 2005
Video i/p definition : Analog
Checksum         : 6B
EEROM data table :
00 FF FF FF FF FF 00 05 E3 25 A7 01 00 00 00
16 0F 01 03 68 22 1B 78 2A 36 AD A2 59 4C 97 24
17 50 56 BF EF 00 01 00 01 01 01 01 01 01 01
01 01 01 01 01 01 BC 34 00 98 51 00 2A 40 10 90
13 00 54 0E 11 00 00 1E 00 00 00 FF 00 31 32 33
35 35 4A 41 30 30 30 30 31 00 00 00 FD 00 37
4B 1E 53 0E 00 0A 20 20 20 20 20 20 00 00 FC
00 4C 4D 37 32 35 0A 20 20 20 20 20 20 00 6B
data compare OK !

```

Notes:

1. Make sure the system time of PC is in accordance with the real time before writing.
2. The schematic picture is just as an example for description; the exact content of the DDC is dependent on the serial number of the BARCORD of this model.
3. Data DDC-writing needs a transfer interface.

Instruction : DDC-writing needs 4 files:

1. Barcode.txt (Supply Barcode length and flow number)
2. *.EXE (DDC-writing program)
3. WR.bat (Group order file for cycling utilization of *.EXE, and dual-click this file when perform DDC-writing)
4. W.dat (The content with 128 bits of DDC)

14. BOM List

Part NO	Description	Quantity	Unit	Remark
CBPC780KCDDL	CONVERSION BOARD VER:A00,V6C08	1	PCS	For CPT panel
CBPC780KGDDL	CONVERSION BOARD VER:A00,V6C08	1	PCS	For LPL panel
PWPC1742CPD2P	POWER BOARD VER:A00	1	PCS	For CPT panel
PWPC1742LGD2P	POWER BOARD VER:A00	1	PCS	For LPL panel
15G6261 1	BRACKET	2	PCS	For CPT panel
15G6261 1	BRACKET	4	PCS	For LPL panel
15G8187 1	MAIN FRAME-CPT/LPL	1	PCS	For CPT/LPL panel
15G8187 4	MAIN FRAME	1	PCS	For LPL panel
750GLC70A07 5Z D	CPT 17" ZBD PANEL	1	PCS	For CPT panel
750GLG70E1T31Z D	LPL 17" TLB3 ZBD PANEL	1	PCS	For LPL (TLB3) panel
750GLG70E1T41Z D	LPL 17" TLB4 ZBD PANEL	1	PCS	For LPL (TLB4) panel

Location	Part NO	Description
	Q1G6019 1	SCREW
	KEPC780KF2P	KEY BOARD
	11G6080 1	SPACER SUPPORT
	15G8146 1	KEYSINGTON BRACKET
	15G8185 1	HOLDER BRACKET R
	15G8186 1	HOLDER BRACKET L
	19G 588 1	SPRING HOLDER
	19G 589 1	SPRING BUTTON
	20G 027 2	STAND HOLDER
	23G3178700 3A	LOGO
	26G 800700 6A	S/N LABEL
	33G4884ASN L	BUTTON FUNC
	33G4885 Y2 L	BUTTON RELEASE
	34G1611AY2 B	BEZEL
	34G1612 Y2 B	REAR COVER
	40G 17N700 1A	ID LABEL
	40G 58162435A	LABEL
	40G 581700 3A6813	CARTON LABEL
	41G7800700 8A	E176 DAO PIG
	41G780070010A	QSG
	44G3586 3EPE	EPE
	44G3586BRO 2	PAPER BLOCK

	44G3770 1	EPS(L)
	44G3770 2	EPS(R)
	44G3770700 2A	CARTON
	44G3770BRO 1	PAPER BLOCK
	45G 88606 8	PE BAG FOR BASE
	45G 88607DE8	PE BAG
	52G 1186	SMALL TAPE
	52G6020 2DE9	FILM PROTECT
	52G6022 1500	SMALL TAPE
	52G6025 11848	MYLAR FOR POWER BOARD
	52G6025 11900	MYLAR FOR STAND HOLDER
	52G6025 11905	MYLAR
	52G6025 11923	MYLAR FOR SEFETY
	70G1700700 2A	CD MANUAL
	85G 702 1	SHIELD WIRE
	85G 703 1	SHIELD LAMP
	89G402A18NISD	POWER CORD
	95G8018 30 80	LVDS HARNESS
	M1G 130 4 47	SCREW
	M1G 330 4128	SCREW M3X4
	M1G1740 6128	SCREW
	M1G2940 10225	SCREW
	M1G3030 5125	SCREW
	Q1G6019 1	SCREW
	705G 780 87 D1	CN901 ASS'Y
	89G 728LAA 2	SIGNAL CABLE
	AIC780KCDDLDP	MAIN BOARD
	40G 457624 1B	LABEL-CPU
	40G 45762412B	CBPC LABEL
C101	67G309V220 3	22UF +-20% 16V
C401	67G309V220 3	22UF +-20% 16V
C409	67G309V220 3	22UF +-20% 16V
C416	67G309V220 3	22UF +-20% 16V
C419	67G309V220 3	22UF +-20% 16V
C425	67G309V220 3	22UF +-20% 16V
C701	67G309V220 3	22UF +-20% 16V
C710	67G309V220 3	22UF +-20% 16V
C711	67G309V220 3	22UF +-20% 16V
C717	67G309V220 3	22UF +-20% 16V

CN101	33G8043 24 H	CONNECTER
CN403	33G8019 8C H	CONNEETER
CN405	88G 35315F H	D-SUB 15PIN
CN701	33G8027 12	WAFER 2*6P 2.0MM R/A
X401	93G 22 53	CRYSTAL 14.318MHzHC-49U
	715G1565 1	MAIN BOARD PCB
C102	65G0603104 12	CER2 0603 X7R 16V 100N
C402	65G0603104 12	CER2 0603 X7R 16V 100N
C403	65G0603104 12	CER2 0603 X7R 16V 100N
C404	65G0603104 12	CER2 0603 X7R 16V 100N
C405	65G0603104 12	CER2 0603 X7R 16V 100N
C406	65G0603104 12	CER2 0603 X7R 16V 100N
C407	65G0603104 12	CER2 0603 X7R 16V 100N
C410	65G0603104 12	CER2 0603 X7R 16V 100N
C411	65G0603104 12	CER2 0603 X7R 16V 100N
C412	65G0603104 12	CER2 0603 X7R 16V 100N
C413	65G0603104 12	CER2 0603 X7R 16V 100N
C414	65G0603104 12	CER2 0603 X7R 16V 100N
C417	65G0603104 12	CER2 0603 X7R 16V 100N
C418	65G0603104 12	CER2 0603 X7R 16V 100N
C420	65G0603104 12	CER2 0603 X7R 16V 100N
C421	65G0603104 12	CER2 0603 X7R 16V 100N
C422	65G0603104 12	CER2 0603 X7R 16V 100N
C423	65G0603104 12	CER2 0603 X7R 16V 100N
C424	65G0603104 12	CER2 0603 X7R 16V 100N
C426	65G0603104 12	CER2 0603 X7R 16V 100N
C427	65G0603330 31	CER1 0603 NP0 50V 33P P
C428	65G0603330 31	CER1 0603 NP0 50V 33P P
C430	65G0603104 12	CER2 0603 X7R 16V 100N
C431	65G0603104 12	CER2 0603 X7R 16V 100N
C432	65G0603473 32	CHIP 0.047UF 50V X7R
C433	65G0603473 32	CHIP 0.047UF 50V X7R
C434	65G0603473 32	CHIP 0.047UF 50V X7R
C435	65G0603224 17	CAP:CER 0.22UF-20%-80%
C436	65G0603473 32	CHIP 0.047UF 50V X7R
C437	65G0603473 32	CHIP 0.047UF 50V X7R
C438	65G0603473 32	CHIP 0.047UF 50V X7R
C439	65G0603104 12	CER2 0603 X7R 16V 100N
C441	65G0603104 12	CER2 0603 X7R 16V 100N

C442	65G0603220 31	CER1 0603 NP0 50V 22P P
C443	65G0603220 31	CER1 0603 NP0 50V 22P P
C444	65G0603104 12	CER2 0603 X7R 16V 100N
C445	65G0603104 12	CER2 0603 X7R 16V 100N
C446	65G0603104 12	CER2 0603 X7R 16V 100N
C454	65G0603104 32	CHIP 0.1UF 50V X7R
C455	65G0603104 32	CHIP 0.1UF 50V X7R
C456	65G0603104 32	CHIP 0.1UF 50V X7R
C457	65G0603104 32	CHIP 0.1UF 50V X7R
C458	65G0603104 12	CER2 0603 X7R 16V 100N
C703	65G0603104 12	CER2 0603 X7R 16V 100N
C704	65G0603104 12	CER2 0603 X7R 16V 100N
C707	65G0603104 12	CER2 0603 X7R 16V 100N
C708	65G0603104 12	CER2 0603 X7R 16V 100N
C712	65G0603104 12	CER2 0603 X7R 16V 100N
C713	65G0603104 12	CER2 0603 X7R 16V 100N
C715	65G0603104 12	CER2 0603 X7R 16V 100N
C718	65G0603104 12	CER2 0603 X7R 16V 100N
D403	93G 6433P	BAV99
D404	93G 6433P	BAV99
D405	93G 6433P	BAV99
D406	93G 39146	LL5232B
D407	93G 64 42 P	BAV70 SOT-23
D408	93G 39146	LL5232B
D409	93G 39146	LL5232B
D410	93G 39146	LL5232B
D411	93G 39146	LL5232B
D412	93G 39146	LL5232B
D704	93G2004 2	SR24/PANJIT-SMT
FB401	71G 56K121 M	CHIP BEAD
FB402	71G 56K121 M	CHIP BEAD
FB403	71G 56K121 M	CHIP BEAD
FB404	71G 56K121 M	CHIP BEAD
FB405	71G 56K121 M	CHIP BEAD
FB406	71G 56K121 M	CHIP BEAD
FB410	71G 59C600 GP	CHIP BEAD 50 OHM 1608 F
FB411	71G 59C600 GP	CHIP BEAD 50 OHM 1608 F
FB412	71G 59C600 GP	CHIP BEAD 50 OHM 1608 F
FB702	71G 56K121 M	CHIP BEAD

Q401	57G 417 4	PMBS3904/PHILIPS-SMT(04
Q403	57G 417 4	PMBS3904/PHILIPS-SMT(04
Q703	57G 417 4	PMBS3904/PHILIPS-SMT(04
Q704	57G 763 1A	AP2305N
Q706	57G 417 4	PMBS3904/PHILIPS-SMT(04
R101	61L0603472	RST SM 0603 RC0603 4K7
R402	61L0603249 0F	CHIP 249OHM 1/16W 1%
R406	61L0603472	RST SM 0603 RC0603 4K7
R407	61L0603472	RST SM 0603 RC0603 4K7
R408	61L0603472	RST SM 0603 RC0603 4K7
R409	61L0603101	RST SM 0603 RC0603 100R
R410	61L0603101	RST SM 0603 RC0603 100R
R411	61L0603101	RST SM 0603 RC0603 100R
R416	61L0603472	RST SM 0603 RC0603 4K7
R417	61L0603472	RST SM 0603 RC0603 4K7
R419	61L0603000	RST SM 0603 JUMP MAX 0R
R421	61L0603562	CHIP 5.6K OHM 1/10W
R422	61L0603103	RST SM 0603 RC0603 10K
R423	61L0603472	RST SM 0603 RC0603 4K7
R424	61L0603472	RST SM 0603 RC0603 4K7
R425	61L0603472	RST SM 0603 RC0603 4K7
R426	61L0603103	RST SM 0603 RC0603 10K
R427	61L0603472	RST SM 0603 RC0603 4K7
R429	61L0603103	RST SM 0603 RC0603 10K
R432	61L0603472	RST SM 0603 RC0603 4K7
R434	61L0603750	RST SM 0603 RC22H 75R P
R435	61L0603750	RST SM 0603 RC22H 75R P
R436	61L0603750	RST SM 0603 RC22H 75R P
R438	61L0603750 9F	75OHM 1% 1/10W
R439	61L0603750 9F	75OHM 1% 1/10W
R440	61L0603750 9F	75OHM 1% 1/10W
R441	61L0603101	RST SM 0603 RC0603 100R
R442	61L0603101	RST SM 0603 RC0603 100R
R443	61L0603101	RST SM 0603 RC0603 100R
R444	61L0603103	RST SM 0603 RC0603 10K
R445	61L0603221	RST SM 0603 RC0603 220R
R446	61L0603221	RST SM 0603 RC0603 220R
R447	61L0603221	RST SM 0603 RC0603 220R
R448	61L0603222	RST SM 0603 RC0603 2K2

R449	61L0603222	RST SM 0603 RC0603 2K2
R450	61L0603472	RST SM 0603 RC0603 4K7
R451	61L0603472	RST SM 0603 RC0603 4K7
R452	61L0603472	RST SM 0603 RC0603 4K7
R453	61L0603221	RST SM 0603 RC0603 220R
R454	61L0603221	RST SM 0603 RC0603 220R
R455	61L0603221	RST SM 0603 RC0603 220R
R457	61L0603101	RST SM 0603 RC0603 100R
R458	61L0603101	RST SM 0603 RC0603 100R
R459	61L0603473	RST SM 0603 RC0603 47K
R460	61L0603473	RST SM 0603 RC0603 47K
R461	61L0603221	RST SM 0603 RC0603 220R
R462	61L0603221	RST SM 0603 RC0603 220R
R463	61L0603221	RST SM 0603 RC0603 220R
R464	61L0603221	RST SM 0603 RC0603 220R
R465	61L0603221	RST SM 0603 RC0603 220R
R466	61L0603103	RST SM 0603 RC0603 10K
R467	61L0603103	RST SM 0603 RC0603 10K
R468	61L0603103	RST SM 0603 RC0603 10K
R469	61L0603303	CHIP 30K OHM 5% 1/10W
R470	61L0603223	CHIPR 22K OHM +-5% 1/10
R471	61L0603223	CHIPR 22K OHM +-5% 1/10
R472	61L0603303	CHIP 30K OHM 5% 1/10W
R474	61L0603472	RST SM 0603 RC0603 4K7
R477	61L0603472	RST SM 0603 RC0603 4K7
R705	61L0603472	RST SM 0603 RC0603 4K7
R707	61L0603102	RST SM 0603 RC0603 1K P
R708	61L0603102	RST SM 0603 RC0603 1K P
R710	61L0603102	RST SM 0603 RC0603 1K P
R714	61L0603473	RST SM 0603 RC0603 47K
R721	61L0603000	RST SM 0603 JUMP MAX 0R
R723	61L0603473	RST SM 0603 RC0603 47K
R725	61L0603473	RST SM 0603 RC0603 47K
U401	56G 562101	GM2621-LF-BC
U402	56G1133 59CD2	SST25VF010-20-4C-SAE SO
U404	56G1133 34	M24C02-WMN6TP
U701	56G 585 4	AIC1117-33CY
U702	56G 563 27	AIC1117A-18CY SOT-223
	AIK780KF2SMTP	KEY BOARD

	715G1564 1	PCB
C01	65G0603104 12	CER2 0603 X7R 16V 100N
C02	65G0603104 12	CER2 0603 X7R 16V 100N
CN1	89G176S 8 4	FFC CABLE
LED01	81G 14501 KT	CHIP LED
SW01	77G 605 1 AL GP	SMD SWITCH
SW02	77G 605 1 AL GP	SMD SWITCH
SW03	77G 605 1 AL GP	SMD SWITCH
SW04	77G 605 1 AL GP	SMD SWITCH
ZD01	93G 39S 34 T	UDZS5.6B
ZD02	93G 39S 34 T	UDZS5.6B
ZD03	93G 39S 34 T	UDZS5.6B
ZD04	93G 39S 34 T	UDZS5.6B
ZD05	93G 39S 34 T	UDZS5.6B
ZD06	93G 39S 34 T	UDZS5.6B
	PW1742CPD2SMTP	POWER BOARD
	40G 45762420A	ID LABEL
	52G6025 11935	MYLAR FOR PANEL
	705G 780 57 D1	Q901 ASS'Y
	705G 780 57 D2	Q203 ASS'Y
	705G 780 93 D1	D921/D922 ASS'Y
C203	67G215L471 4N	KY25VB470M-L10*16
C211	65L 3J1806ET	18PF 5% 3KV TDK
C212	65L 3J1506ET	15PF 3KV 5%
C213	65L 3J1506ET	15PF 3KV 5%
C214	65L 3J1806ET	18PF 5% 3KV TDK
C221	63G211J334 AB	0.33UF 5% 160V R75 BY A
C900	65G306M4722BP	4700PF +-20% 400VAC
C901	65G305M2222BP	2200PF +-20%
C902	65G305M2222BP	2200PF +-20%
C903	63G 107474 HS	0.47UF +-20% 275VAC
C904	67G215S10115K	100UF 450V
C923	67G215L102 4R	LOW E.S.R 1000UF +/-20%
C924	67G215L102 4R	LOW E.S.R 1000UF +/-20%
C925	67G215L471 4N	KY25VB470M-L10*16
C926	67G215Y4713NV	KY16VB470M-CC3 8*15MM
C931	67G215L102 4R	LOW E.S.R 1000UF +/-20%
CN201	33G8021 2D AC	CONN.2P R/A 87210-0236
CN202	33G8021 2D AC	CONN.2P R/A 87210-0236

CN203	33G8021 2D AC	CONN.2P R/A 87210-0236
CN204	33G8021 2D AC	CONN.2P R/A 87210-0236
CN901	33G8029 3A H	B2P3S-VH
CN902	95G8014 12523	WIRE
D901	93G 6026W52T	FR107
DB901	93G 50460502	KBP206G
IC902	56G 139 3A	PC123Y22FZOF
L201	73G 253515 L	CHOKE COIL
L901	73L 174 50 LH	LINE FILTER
L902	73G 174 65 LS	LINE FILTER BY LISHIN
L903	73G 253 91 H	CHOKE COIL
L904	73G 253 91 H	CHOKE COIL
NR901	61G 58080 WT	8 OHM NCT
PT201	80GL17T 28 YS	X'FMR YSTDA500101G
PT202	80GL17T 28 YS	X'FMR YSTDA500101G
Q206	57G 761 7	KTD1691P
Q207	57G 761 7	KTD1691P
R908	61G152M10458G6267	100K OHM 5% 2W
R918	61G152M398 64	0.39 OHM 2W
T901	80GL17T 29 LS	ADAPTOR BY LISHIN
	PW1742CPD2AIP	POWER BOARD
C201	65G0805104 22	0.1UF +-10% 25V X7R 080
C202	65G0805104 22	0.1UF +-10% 25V X7R 080
C204	65G0805104 22	0.1UF +-10% 25V X7R 080
C205	65G0805105 22 GP	CHIP 1UF 25V X7R 0805
C207	65G0805331 32	CHIP 330P 50V X7R 0805
C208	65G0805104 22	0.1UF +-10% 25V X7R 080
C210	65G0805105 22 GP	CHIP 1UF 25V X7R 0805
C222	65G0805474 22	CHIP 0.47UF 25V X7R 080
C223	65G0805105 22	CHIP 1UF 25V X7R 0805
C907	65G0805104 32	CHIP 0.1U 50V X7R
C911	65G0805471 31	CHIP 470PF 50V NPO
C912	65G0805102 32	CHIP 1000P 50VX7R 0805
C927	65G0805104 32	CHIP 0.1U 50V X7R
C928	65G0805104 32	CHIP 0.1U 50V X7R
C929	65G0805104 32	CHIP 0.1U 50V X7R
C932	65G0805474 22	CHIP 0.47UF 25V X7R 080
D201	93G 60264	B340A
D210	93G 6432P	LL4148

D903	93G 6432P	LL4148
D923	93G 6432P	LL4148
D924	93G 6432P	LL4148
F902	61L1206000	RST SM 1206 JUMP MAX 0R
IC201	56G 608 1	TL1451ACD
IC901	56G 379 54	NCP1203D60R2G BY ON
Q201	57G 760 5	DTC144WKA BY ROHM SMT
Q202	57G 760 4	DTA144WKA BY ROHM SMT
Q204	57G 417 4	PMBS3904/PHILIPS-SMT(04
Q205	57G 417 6	PMBS3906/PHILIPS-SMT(06
R201	61L0805240 1F	CHIPR 2.4KOHM +-1% 1/8W
R202	61L0805221	CHIPR 220 OHM +-5% 1/8W
R203	61L0805240 1F	CHIPR 2.4KOHM +-1% 1/8W
R204	61L0805471	CHIPR 470 OHM+-5% 1/8W
R205	61L0805163	CHIP 16KOHM 1/10W
R206	61L0805123	CHIP 12KOHM 1/8W
R207	61L0805103	CHIPR 10K OHM +-5% 1/8W
R208	61L0805000	CHIP O OHM 1/8W
R209	61L0805000	CHIP O OHM 1/8W
R210	61L0805473	CHIPR 47K OHM +-5% 1/8W
R212	61L0805623	CHIPR 62K OHM +-5% 1/8W
R213	61L0805472	CHIPR 4.7K OHM +-5% 1/8
R214	61L0805123	CHIP 12KOHM 1/8W
R229	61L0805681	680 OHM 1/10W
R230	61L0805471	CHIPR 470 OHM+-5% 1/8W
R231	61L0805123	CHIP 12KOHM 1/8W
R232	61L0805510 2F	CHIP 51K OHM 1/10W
R900	61L1206334	330K 1/4W
R901	61L1206334	330K 1/4W
R902	61L1206334	330K 1/4W
R903	61L1206332	CHIP 3.3K OHM 5% 1/8W
R904	61L1206332	CHIP 3.3K OHM 5% 1/8W
R905	61L1206332	CHIP 3.3K OHM 5% 1/8W
R909	61L0805220	CHIP 22 OHM 5% 0805 1/8
R910	61L0805222	CHIP 2.2KOHM 5% 0805 1/
R911	61L0805362	CHIP 306KOHM 1/8W
R912	61L0805101	CHIPR 100 OHM +-5% 1/8W
R913	61L0805753	75K 1/8W
R914	61L0805472	CHIPR 4.7K OHM +-5% 1/8

R915	61L0805220	CHIP 22 OHM 5% 0805 1/8
R916	61L0805221	CHIPR 220 OHM +-5% 1/8W
R917	61L0805103	CHIPR 10K OHM +-5% 1/8W
R919	61L0805203	CHIPR 20KOHM +-5% 1/8W
R924	61L0805102	CHIPR 1K OHM +-5% 1/8W
R925	61L1206000	RST SM 1206 JUMP MAX 0R
R929	61L0805330 2F	CHIP 33KOHM 1/8W 1%
R930	61L0805360 1F	CHIP 3.6KOHM 1/8W 1%
R931	61L0805102	CHIPR 1K OHM +-5% 1/8W
R932	61L0805102	CHIPR 1K OHM +-5% 1/8W
R933	61L0805240 1F	CHIPR 2.4KOHM +-1% 1/8W
ZD201	93G 39S 8 T	RLZ11B LLDS
ZD901	93G 39S 44 T	RLZ18B LLDS
ZD902	93G 39S 25 T	RLZ5.1B LLDS
ZD903	93G 39S 38 T	PTZ 9.1B
ZD904	93G 39S 40 T	RLZ 13B LLDS
ZD905	93G 39S 25 T	RLZ5.1B LLDS
	715G1492 1 FR	PCB
C209	67G 305330 7T	33UF 105
C904	6G 31502	1.5MM RIVET
C905	65G 2K152 1T6921	1.5NF/2KV Y5P +-10%
C906	67G 2151014KT	100UF
C909	67G 3054704KT	47UF
C921	65G517K102 5T	1000PF 10% Y5P 500V
C922	65G517K102 5T	1000PF 10% Y5P 500V
CN901	6G 31500	EYELET
D202	93G 64 1152T	1N4148
D203	93G 64 1152T	1N4148
D204	93G 64 1152T	1N4148
D205	93G 64 1152T	1N4148
D206	93G 64 1152T	1N4148
D207	93G 64 1152T	1N4148
D208	93G 64 1152T	1N4148
D209	93G 64 1152T	1N4148
D902	93G1020 752T	UF4003
F901	84G 56 1	FUSE 2A 250V WICKMANN
IC903	56G 158 12	KIA431A-AT/P TO-92
J914	71G 55 9 T	FERRITE BEAD
L902	6G 31502	1.5MM RIVET

Q901	6G 31502	1.5MM RIVET
Q902	57G 420 PP T	2PA733P
Q903	57G 419 PP T	2PC945P
R221	61G 17218252T	1.8KOHM 5% 1/4W
R222	61G 17218252T	1.8KOHM 5% 1/4W
R223	61G 17218252T	1.8KOHM 5% 1/4W
R224	61G 17218252T	1.8KOHM 5% 1/4W
R225	61G 17210252T	1K OHM 5% 1/4W
R226	61G 17210252T	1K OHM 5% 1/4W
R227	61G 17210252T	1K OHM 5% 1/4W
R228	61G 17210252T	1K OHM 5% 1/4W
R921	61G175L47052T	47OHM +-5% 1/2W
R922	61G175L47052T	47OHM +-5% 1/2W
R923	61G 17256152T	560 OHM 5% 1/4W
T901	6G 31502	1.5MM RIVET
	90G6240 1	HEAT SINK
	M1G1730 8128	SCREW M3x8
Q901	57G 749 1C	2SK3264
	15G6284 1	PLATE
	90G 411501	HEAT SINK
	M1G 330 4128	SCREW M3X4
Q203	57G 763 12	AOU401 BY AOS
	90G6240 2	HEAT SINK
	M1G1730 8128	SCREW M3x8
D921	93G 60239	FME-210B T0-220
D922	93G1506 2	FMW-2156
	87G 501 14 RF	AC SOCKET
	95G 900595	WIRE
	95G8021 3 11	HARNESS
	96G 29 6	SHRINK TUBE UL/CSA
	12G6097 1	PORON
	15G8188 1	BASE BKT
	15G8190 1	VESA-PLATE
	20G 030 1	STAND DIE CAST
	34G1614 Y2 B	VESA COVER
	34G1615 SN B	RISER FRONT
	34G1616 Y2 B	RISER BACK
	34G1617AST B	BASE
	37G 535 2	HINGE ASS'Y(17")

	M1G 130 6125	SCREW
	M1G 130 8120	SCREW
	M1G 140 8225	SCREW M3X8
	Q1G 130 8 47	SCREW

15. Definition Of Pixel Defects

15.1 CLAA170EA 07

DEFECT TYPE		LIMIT		Note	
VISUAL DEFECT	SCRATCH		$0.01\text{mm} \leq W \leq 0.05\text{mm}$ $L \leq 10\text{mm}$	$N \leq 4$	-
	INTERNAL	SPOT	$0.15\text{mm} \leq \varphi \leq 0.5\text{mm}$	$N \leq 4$	Note1
		FIBER	$W \leq 1.0\text{mm}, L \leq 3\text{mm}$	$N \leq 4$	Note1
		POLARIZER BUBBLE	$0.15\text{mm} \leq \varphi \leq 0.5\text{mm}$	$N \leq 4$	Note1
		TOTAL	$N \leq 8$		-
ELECTRICAL DEFECT	BRIGHT DOT		$N \leq 0(\text{FLASH DOT } N \leq 0)$		Note2
	DARK DOT		$N \leq 4$		-
	TOTAL DOT		$N \leq 5$		Note2
	TWO ADJACENT DOT		$\leq 2\text{ PAIRS}$		Note3
	THREE OR MORE ADJACENT DOT		NOT ALLOWED		-
	DISTANCE BETWEEN DEFECT DOT		Two dark dots $\geq 10\text{mm}$		Note4
	LINE DEFECT		NOT ALLOWED		-

One pixel consists of 3 sub-pixels, including R,G, and B dot.(Sub-pixel = Dot)

[Note1] W : Width[mm], L : Length[mm], N : Number, φ : Average Diameter

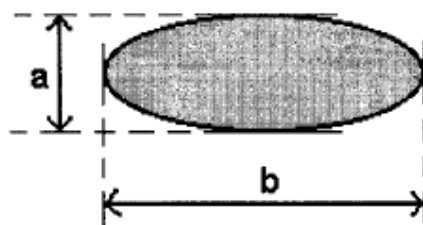

$$\varphi = (a + b) / 2$$

1. (White, black) Spot
2. Polarizer Bubble

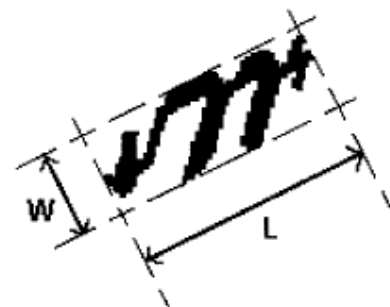

1. Fiber

[Note2] Bright dot is defined through 5% transmission ND Filter as following.

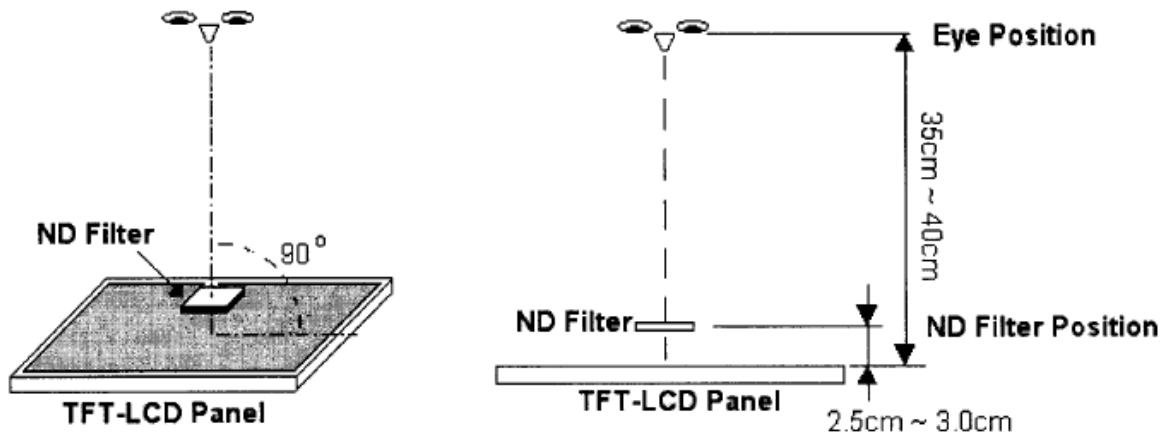

[Note3] Judge defect dot and adjacent dot as following. Allow below (as A, B, C and D status) adjacent defect dots, including bright and dark adjacent dot. And they will be counted 2 defect dots in total quantity.

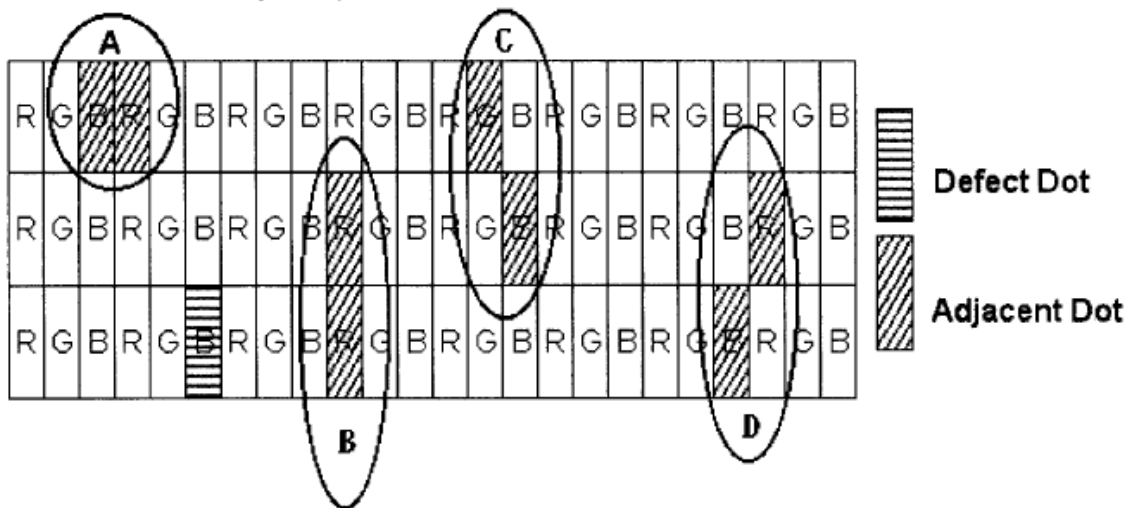

[Note4] Definition of distance between defect dot as following.

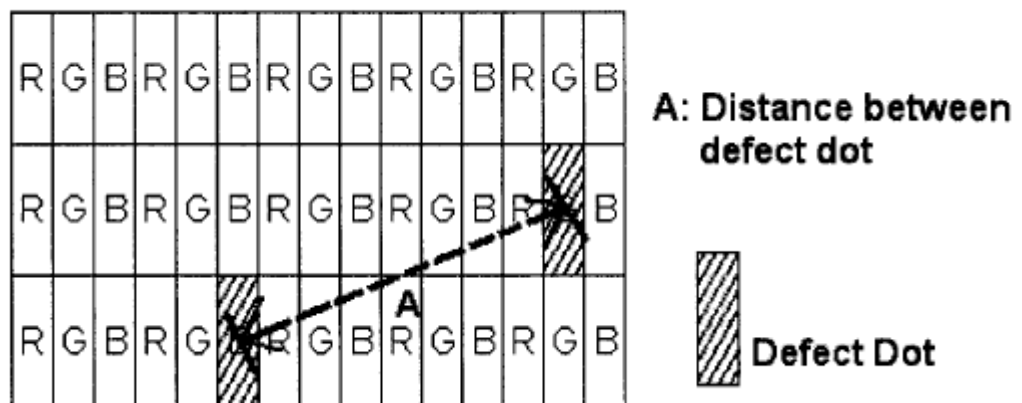

[Note5] Other

- (1) The defects that are not defined above and considered to be problem shall be reviewed and discussed by both parties.
- (2) Defects on the Black Matrix, out of Display area, are not considered as a defect or counted.

15.2 LM170E01-TLB3 / LM170E01-TLB4

15.2.1 Dot Defect

15.2.1.1 Bright Dot

Dots (sub-pixels) which appeared brightly in the screen when the LCM displayed with dark pattern.

- R, G or B 1 dot ----- 0 Max
- Adjacent 2 dots ----- 0 Max
- Total amount of Bright dots ----- 0 Max
- Minimum distance of Bright dots ----- NA

15.2.1.2 Dark Dot

Dots (sub-pixels) which appeared darkly in the screen when the LCM displayed with bright pattern.

- 1 dot ----- 4 Max
- Adjacent 2 dots ----- 2 Max
- Total amount of Dark dot ----- 4 Max
- Minimum distance of Dark dots ----- 15mm

15.2.1.3 Total amount of Dot Defects ----- 5 Max (Combination)

Note) a. Every dot herein means Sub-Pixel (Each Red, Green, or Blue Color)

b. Bright dot

- Red or Blue dots smaller than half size of sub-pixel are not counted as a defect dots.
- Green dots smaller than 1 / 3 size of sub-pixel are not counted as a defect dots.

c. Dark dots smaller than half size of sub-pixel are not counted as a defect dots.

15.2.2. Polarizer Defects

Items		Criteria
Scratches	Linear	$0.01 \leq W \leq 0.1, 0.3 \leq L \leq 10, N \leq 4$
Dent	Circular	$0.15 \leq D \leq 0.5, N \leq 3$

Where, W: Width

L: Length

D: Average diameter $= (a+b)/2$

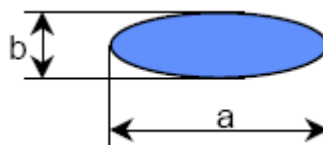

- a. Extraneous substances, which can be wiped out, like Finger Print, Particles, are not considered as a defect.
- b. Defects which are on the Black Matrix (outside of Active Area) are not considered as a defect.

15.2.3 Foreign Material

Items	Criteria
Linear	$0.05 \leq W \leq 0.1, 0.3 \leq L \leq 4.0, N \leq 4$
Circular	$0.15 \leq D \leq 0.5, N \leq 4$

Where, W: Width

L: Length

D: Average diameter $= (a+b)/2$

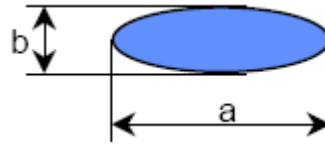

15.2.4 Line Defect

All kinds of line defects such as vertical, horizontal or cross are not allowed.

15.2.5 Bezel Appearance

Scratches, minor dents, stain, particles on the Bezel frame are not considered as a defect.

15.2.6 others

Issues, which are not defined in these criteria, shall be discussed with both parties, Customer and Supplier, for better solution.